

2018 SURGICAL Instruments Catalogue

41 Years in
Ophthalmology

QUALITY | SERVICE | INTEGRITY



APPASAMY OPHTHALMIC SURGICAL INSTRUMENTS



**and group of companies
India**

Most photographs of this Catalogue are nearly equal to actual size of products. Enlarged illustrations are used for essential details and easy perception.

Unless otherwise stated, surgical instruments are made of surgical quality stainless steel.

Due to continuous development and improvement, the given specification, the product design and construction are subject to change without any notice.

All photographs, illustrations and text of this catalogue should not be reproduced in any manner and all are protected by copyright. Reproduction in any form, to promote business (other than permitted reprints to promote the products of APPASAMY ASSOCIATES and its group of companies) are expressly prohibited.

RD-SI/CAT/Rev01.2017

To Our beloved and respected customers

We present before you a comprehensive catalogue, now an improved and concise one.

We try to serve you better and make things easier for you. Please make best use of this catalogue for ordering products and services required.

We constantly try to upgrade the quality of instruments and equipment. We need your unending suggestions intended for the improvements of quality and service of our products. Your suggestions are necessary, to serve you better-pleasantly, efficiently and reliability.

Your suggestion to improve the contents of this catalogue are most welcome.

Thank you for being with us, supporting us for the last 41 years. We count your continued patronage – FOREVER.

With best Regards.

P.S.N. Appasamy

P.S.N.APPASAMY

On behalf of all members and staff of
Appasamy Associates and group of companies.



Since July 1977, **Appasamy Associates** and its group companies are the leading and dedicated manufacturers of ophthalmic products in India. We manufacture equipment of ophthalmic products in India. We manufacture equipment for diagnosis and surgery, Intraocular Lenses, Micro- Surgical Instruments and Ophthalmic Pharmaceuticals.

Our four decades (41 Forty One Years) of sincere and hard work had resulted in bringing the modern and state of the art ophthalmic surgeons and visioncare professional at an affordable cost. We played a very important role, in making the Indian Ophthalmic Surgeons achieving the CSR (Cataract Surgery Ratio) on par with developed nations. Our various dedicated R&D teams work throughout the year to bring state of the art and innovative ophthalmic products. Appasamy Associates spend almost 20% of its sales turnover to improve the existing products and develop new innovative products.

We have manufacturing facilities at Tamilnadu (Chennai), Pondicherry, West Bengal (Kolkata) and Himachal Pradesh (Baddi). We have more than 40 sales offices and service centres throughout India and directly reach the doorsteps of each and every ophthalmic surgeon practicing in India. Our quality Management Systems are in place and all the manufacturing facilities are certified facilities for ISO 9001:2008 and ISO 13485:2012. Our auditors are DNVGL Business Solutions (Nemko-Presafe) and Institute of Testing & Certification (ITC). We export to more than 100 countries and exhibit our products in all the trade and scientific exhibitions conducted by different ophthalmic associations all over the world. This year, in 2017, we are exhibiting our products 25 th year in succession at American Academy of Ophthalmology, New Orleans, LA, USA



TABLE OF CONTENTS

Catalogue Number Prefix	Description	Page Number
AA 1000 Series	Speculums	03-11
	Retractors	13-14
	Scleral Depressors	15-16
	Knives	16-17
	Dissectors	17-18
	Spuds	18-19
	Lens Manipulators	19-24
	Nucleus Rotators	24-26
	Nucleus Rotators Double End	26-27
	Spatulas	29-34
	Iris Hooks	34-35
	Fixation Rings	35-36
	Mucles Hooks	36-37
	Lens Expressors	37-38
	Curettes and Spoons	38-39
	Lens Loops	40-41
	Cauteries	41-42
	Nucleus Dividers	42-43
Phaco Choppers	43-46	
AA 2000 Series	Corneal Trephines & Graft Holders	49
	Calipers	50-51
	Incision Gauges	51-52
	Incision Markers	52-57
	Pupil Dialators	58
	Lasek & Dsek Instruments	58-61
	DMEK & DALK	62
	Lasik Instruments	63-64
	Vitreo Retinal Spatulas & Peelers	65-68
	Toric Marker	68-70
AA 3000 Series	Iris Forceps	74
	Colibri Forceps	74-76
	Hoskin Forceps	76-77
	Corneal Forceps	78
	Suturing Forceps	75-76

Catalogue Number Prefix	Description	Page Number
AA 3000 Series	Tissue Forceps	75
	Fixation & Superior Rectus Forceps	76-77
	Corneal Fixation Forceps	77-78
	Conjunctiva Forceps	78-79
	Cilia Forceps	79
	Capsular Forceps	79-80
	Muscle Forceps	80
	Chalazion Forceps	81-82
	Trachoma Forceps	82
	Lens Holding Forceps	82-84
	Foldable IOL Forceps	84-88
	Tying Forceps	88-90
	Capsulorhexis Forceps	91-93
	Lasik Forceps	93
	Jewelers Forceps	94
	Foreign Body Removal Forceps	95
	Prechop Forceps	96-97
	Mosquito / Artery Forceps	97-99
	Towel Clamp Forceps	99-100
	General Purpose Forceps	100
Vitreous / Vitreo Retinal	100-104	
AA 4000 Series	Corneoscleral Scissors - Left, Right	106
	Corneoscleral Scissors Universal	107
	Micro Iris Scissors	107
	Corneoscleral Transplant Scissors	108
	Conjunctiva Scissors	109-110
	Vannas & Capsulotomy Scissors	110-112
	Vitreous Scissors	112-113
	Eye & Stich Scissors	113-114
	Tenotomy Scissors	114
	Strabismus Scissors	115
	Enucleation Scissors	115

Catalogue Number Prefix	Description	Page Number
AA 5000 Series	Superior Rectus Needle Holders	118
	Castroviejo Needle Holders	118-119
	Barraquer Needle Holders	119-120
	Troutman Needle Holders	120
	Blade Breakers	121-122
	Blade Handles	122
	Intra Ocular Surgical Blades	123-128
AA 6000 Series	Bone Punches	129
	Corneoscleral Punches	130
	D.C.R / Lacrimal Trephine	130-131
	Lacrimal Probe	132
	Lacrimal Intubation Sets	132-133
	Lacrimal Dilators	133
AA 7000 Series	Lacrimal Cannulas	135
	Air Cannulas	136
	Anterior Chamber Cannulas	136
	A/C Maintainer	137
	Hydrodissection Cannulas	138
	Hydrodelineation Cannulas	139
	Irrigating Cannulas	139-140
	Aspirating Cannulas	141-142
	Irrigating / Aspirating Cannulas	142-148
	Needles	149
	Cystotomes	149-150
	Capsule Polisher Cannulas	150-152
	Irrigating Vectis Cannulas	153
	Irrigating Lens Manipulator Cannulas	154
	Cyclodialysis Cannulas	155
Lasik Cannulas	156-157	
Vitreo-Retinal Instruments	157-165	
AA 8000 Series	Stainless Steel Boxes	166
	Plastic Boxes	167-168
AA 9000 Series	Pinky Ball	170
	Bipolar Forceps	170-171

Catalogue Number Prefix	Description	Page Number
Phaco Surgery Accessories	Endo Illumination Cable	172
	Bimanual I/A Handpiece	173
	Co-Axial I/A Handpiece	174-175
	Phaco Tips	176
	Irrigating Nucleus Choppers	177
Sets	Agarwal Phakonit Set	178
	No Anesthesia Cataract Set	179
	Phakonit St	180
		182-217
Instrument Sets	Microsurgery Cataract & IOL Set	195
	Microsurgery Cataract Set(Compact)	196
	Microsurgery IOL Set (Compact)	197
	Extracapsular Cataract Extraction Set ECCE	198
	Microsurgery Small Incision Non-Phaco Set	199
	Microsurgery ECCE-Phaco Emulsification Set	200
	Intracapsular Cataract Extraction Set (ICCE)	201
	Microsurgery Glaucoma Set	202
	Microsurgery Corneal Transplant Set	203
	Microsurgery LASIK Set	204
	Microsurgery Radial Keratotomy Set	205
	Microsurgery LID set	206
	Microsurgery Chalazion Set	207
	Microsurgery Muscle Set	208
	Microsurgery Pterygium set	209
	Microsurgery Lacrimal Set (DCR)	210
	Vitreo-Retinal Posterior Segment Set	211
	Microsurgery Retina Set	212
	Foreign Body Removal Set	213
	Microsurgery Enucleation Set	214
	Femtosecond Cataract Set	215
	Endothelial Set (DSEAK)	216
	Deep Anterior Lamellar Keratoplasty (DALK) Set	217
	DMEK Set	218
	Implantable Contact Lens Set (ICL)	219
	LASIK Retreatment set	220
	Limbal Relaxation Incision Set (LRI)	221
	Phakic Lens Set	222
	Femtosecond Lasik Set	223
	Intra Corneal Stromal Ring (ICSR) Set	224
	Toric IOL Set	225
	Minor Surgery Set	226

Catalogue Number Prefix	Description	Page Number
Instrument Sets	Phaco 1.8 mm - Bimanual(MICS) Set	227
	Phaco 2.2 mm - Comics Prechop	228
	Phaco 2.8 mm - Cataract Clear Corneal Set	229
	Manual Phaco Fracture Cataract Extraction Set (MSICS)	230
	Oculoplastic Set	231
	Corneal Transplantation Set	232
	LID Set	233
	LRI Set	234
	Glaucoma Set	235
	Pterygium Set	236
	Phacoemulsification Set	237
	Strabismus surgery Set	238
	Comics Surgery Set	239
	Enucleation / Evisceration Set	240
	Femtolasik Set	241
	Femtosecond Cataract Set	242
	Universal Instruments For Vitreoretinal Surgery set	243
	DLEK Set	244
	Muscle Set	245
	MSICS Set	246
	ICRS Set	247
	LASIK Set	248
	Deep Anterior Lamellar Keratoplasty (DALK) Set	249
	Endothelial Transplantation DESK / DSAEK / DMEK Set	250
	ECCE Set	251
	ICL Set	252
	LASEK Set	253
	Chalazation Set	254
	Intra Corneal Stromal Ring (ICSR) Set	255
	Toric IOL Set	256
	MICS Set	257

★ Wire Speculums

★ Eye Speculums

★ Irrigating Speculums

★ Lasik Speculums

Barraquer
Wire Speculum
AA 1004 / AAT 1004 / AAD 1004 Extra Small
Size 5mm Blade.



Barraquer
Wire Speculum
AA 1005 / AAT 1005 / AAD 1005 Small
Size 8mm Blade.



Barraquer
Wire Speculum
AA 1006 / AAT 1006 / AAD 1006
Size 12mm Blade



Barraquer
Nasal Wire Speculum
AA 1008 / AAT 1008 / AAD 1008
Size 15mm Blade.

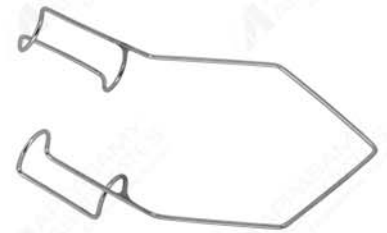

Barraquer
Wire Speculum
AA 1009 / AAT 1009 / AAD 1009 Large
Size 15mm Blade.
AA 1010 / AAT 1010 / AAD 1010 Heavy Wire, Large
Size 15mm Blade.

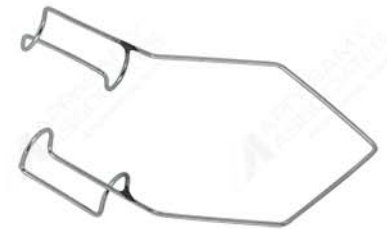

Pannu-Barraquer
Aspirating Speculum
AA 1012 / AAD 1012
Size 15mm Blade.



On Request

Barraquer

Wire Speculum
With Solid Blades

AA 1015 / AAT 1015 / AAD 1015 Small
Size 8mm Blade.

AA 1016 / AAT 1016 / AAD 1016 Big
Size 13mm Blade.



Alfonso

Wire Speculum
With Open Blades

AA 1018 / AAT 1018 / AAD 1018
Size 4mm Wide

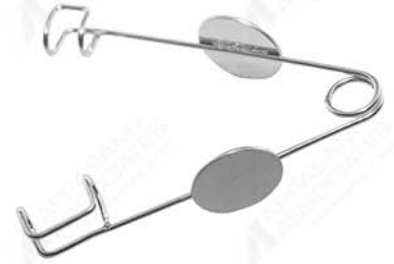

Kratz Barraquer

Wire Speculum Extra Small

AA 1019 / AAT 1019 / AAD 1019
Size 6mm Blade



Kratz-Barraquer

Wire Speculum
With Open Blades for Phaco

AA 1020 / AAT 1020 / AAD 1020 Small
Size 10mm Blade.

AA 1025 / AAT 1025 / AAD 1025 Big
Size 15mm Blade.

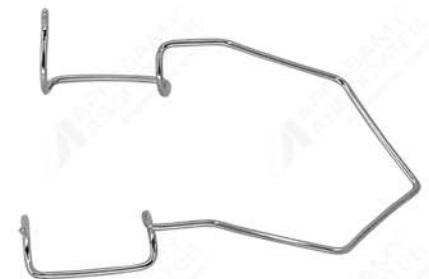

Kalpesh

Wire Speculum
Heavy Wire, Large

AA 1026 / AAT 1026 / AAD 1026
Size 14mm Blade.

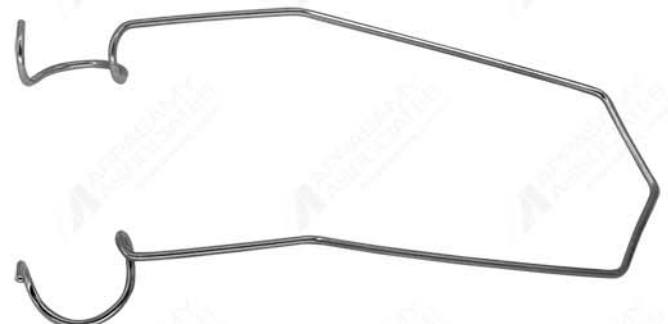

Pannu-Kratz Barraquer
Aspirating Speculum
AA 1027 / AAD 1027
Size 15mm Blade.



On Request

Kratz-Barraquer
Wire Speculum
With Wings
AA 1030 / AAT 1030 / AAD 1030
Size 15mm Blade.

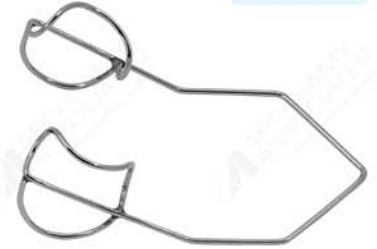

On Request

Neyyas Wire Speculum
Size 12mm Blade
AA 1031 / AAT 1031 / AAD 1031

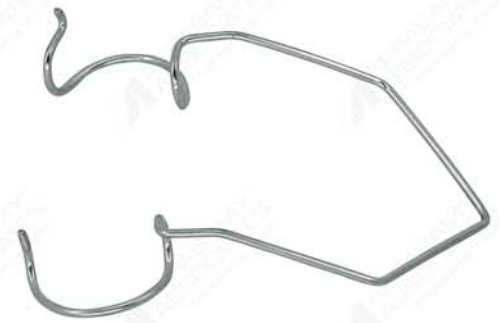

Infant
Wire Speculum
4mm Wide Blades
AA 1035 / AAT 1035 / AAD 1035

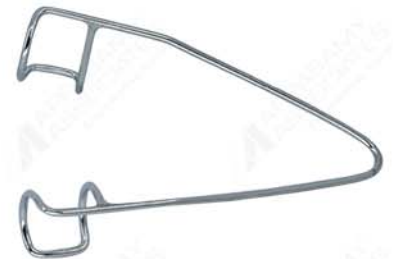

Alfonsa
Wire Speculum
AA 1036 / AAT 1036 / AAD 1036
Size 5.5mm Blade.



On Request

Infant
Wire Speculum Big
AA 1037 / AAT 1037 / AAD 1037
Size 5.5mm Blade.

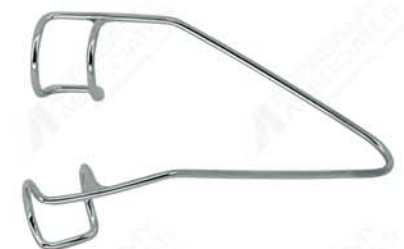

On Request

Mc Intyre

Wire Speculum
with Gently Curved Springs
"V" Shaped Blades

AA 1040 / AAT 1040 / AAD1040 Closed wires
AA 1045 / AAT 1045 / AAD 1045 Open wires

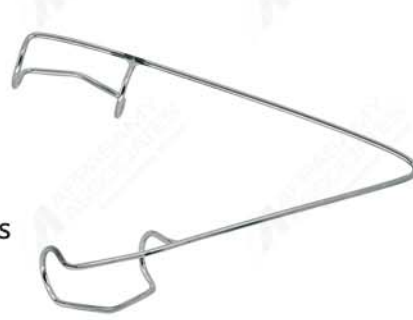

On Request

Thornton-Barraquer

Wire Speculum
The Wings Give
Lift of the Lid off The Globe

AA 1050 / AAT 1050 / AAD 1050



On Request

Grandon-Barraquer

Wire Speculum
With Suture Notches or Holes
To Obtain Additional
Traction For Upper Lid

AA 1055 / AAT 1055 / AAD 1055 Wire blades
AA 1056 / AAT 1056 / AAD 1056 Solid blades

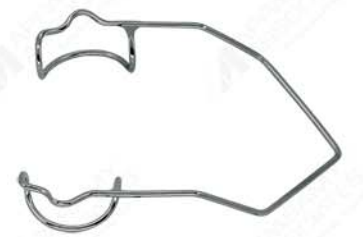

On Request

Tennant

Lid Retractor
May Be Clamped To
Surgical Drape
With Suture or Elastic Band

AA 1060 / AAT 1060 / AAD 1060 Wire Blades,(pair)
AA 1061 / AAD 1061 Solid Blades,(pair)



Sauer

Lid Speculum
AA 1065 / AAD 1065 For Infants
AA 1070 / AAD 1070 For Premature Infants



On Request

Cook

Eye Speculum
With Locking Screw

- AA 1075 / AAD 1075 Solid, Small #1
- AA 1076 / AAD 1076 Solid, Medium #2
- AA 1077 / AAD 1077 Solid, Large #3



Murdock

Eye Speculum
Fenestrated, With Locking Screw

- AA 1080 / AAT 1080 / AAD 1080 Small #1
- AA 1081 / AAT 1081 / AAD 1081 Medium #2
- AA 1082 / AAT 1082 / AAD 1082 Large #3



On Request

Lieberman

Irrigating Speculum
With Six Ports
For Temporal Approach

- AA 1085 / AAT 1085 / AAD 1085 Nasal Speculum
- AA 1086 / AAT 1086 / AAD 1086 Temporal Speculum



On Request

Lieberman

Aspirating Speculum
"V" Shaped Blades
With Six Ports
For Temporal Approach

- AA 1087 / AAT 1087 / AAD 1087 Nasal Speculum
- AA 1088 / AAT 1088 / AAD 1088 Temporal Speculum



Clark

Eye Speculum
Open Blades

- AA 1090 / AAT 1090 / AAD 1090 Small
- AA 1095 / AAT 1095 / AAD 1095 Large



Williams

Eye Speculum
Open Blades

AA 1100 / AAT 1100 / AAD 1100 Small

AA 1105 / AAT 1105 / AAD 1105 Large



Weiss

Eye Speculum
Open Blades

AA 1110 / AAT 1110 / AAD 1110 Small

AA 1115 / AAT 1115 / AAD 1115 Large

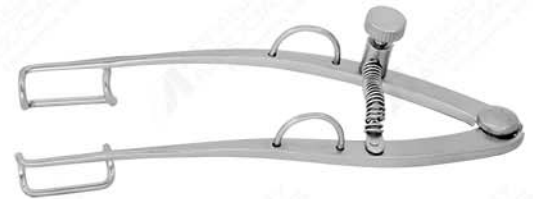

Lancaster

Eye Speculum
Solid Blades

AA 1120 / AAT 1120 / AAD 1120



Agarwal

No Anesthesia
Self Retaining Eye Speculum
Solid Blades

AA 1125 / AAT 1125 / AAD 1125



Lester Burch

Solid Blades
Eye Speculum Solid Blades

AA 1130 / AAD 1130



Castroviejo

Eye Speculum
Open Blades

AA 1140 / AAT 1140 / AAD 1140 Small #1

AA 1142 / AAT 1142 / AAD 1142 Medium #2

AA 1143 / AAT 1143 / AAD 1143 Large #3



Fishkind - Castroviejo

Lid Speculum

With Open Blades For Phaco

AA 1144 / AAT 1144 / AAD 1144



On Request

Mc Pherson

Eye Speculum

Solid Blades

With Vertical Suture Posts

AA 1145 / AAD 1145



On Request

Guyton-Park

Eye Speculum

With Vertical Suture posts
and Canthus Hook

AA 1150 / AAD 1150 Solid Blades

AA 1155 / AAD 1155 Fenestrated Blades



On Request

Maumenee-Park

Eye Speculum

With canthus Hook

and Blade Locking Screw

AA 1160 / AAD 1160 Solid Blades

AA 1165 / AAD 1165 Fenestrated Blades



On Request

Park

Eye Speculum

AA 1170 / AAD 1170 Solid Blades

AA 1175 / AAD 1175 Fenestrated Blades



AA - Stainless Steel, AAT - Titanium, AAD - Disposable Instruments

On Request

Arul

Phaco Speculum

Swivelling Wire

AA 1176 / AAT 1176 / AAD 1176 Nasal Speculum

AA 1177 / AAT 1177 / AAD 1177 Temporal Speculum



On Request

Arul

Phaco Speculum

Fixed Wire

AA 1178 / AAT 1178 / AAD 1178 Nasal Speculum

AA 1179 / AAT 1179 / AAD 1179 Temporal Speculum



On Request

Smirmaul

Eye Speculum

Individually Adjustable

Blades For Elevating Lids

AA 1180 / AAD 1180

Solid Blades

AA 1182 / AAD 1182

Fenestrated Blades

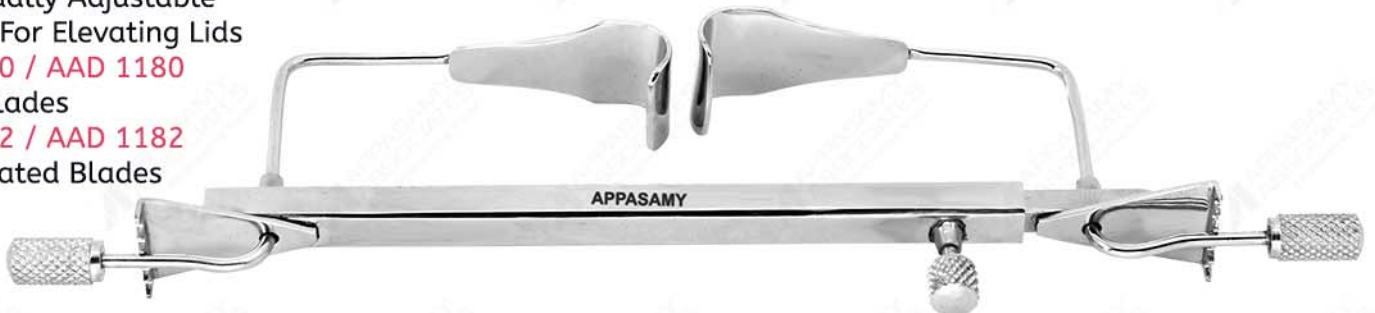

Lieberman - Tennant

Eye Speculum

Fenestrated, Open Blades

For Temporal Placement

AA 1183 / AAT 1183 / AAD 1183 Nasal Speculum

AA 1184 / AAT 1184 / AAD 1184 Temporal Speculum



Mueller

Lacrimal Sac Retractor

Spring Action With Screw Lock

3 X 3 Sharp Prongs

AA 1185 / AAD 1185



AA - Stainless Steel, AAT - Titanium, AAD - Disposable Instruments

Lieberman - Tennant

Eye Speculum

Solid Blades

For Temporal Placement

AA 1186 / AAT 1186 / AAD 1186 Nasal Speculum

AA 1187 / AAT 1187 / AAD 1187 Temporal Speculum



Agricola

Lacrimal Sac Retractor

Spring Action With Screw Lock

3 X 3 Semi Sharp Prongs

AA 1190 / AAD 1190



Castroviejo

Lasik Speculum

AA 1195 / AAT 1195 / AAD 1195



Jerome Bovert

Reversible Speculum

Nasal & Temporal Fit

AAT 1196 / AAD 1196

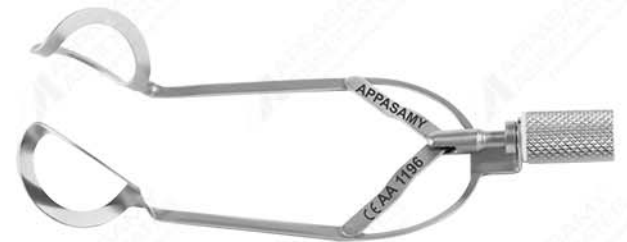

★ Retractors

★ Fixation Rings

★ Scleral Depressors

★ Dissectors & Spuds

★ Curettes & Spatula

★ IOL Manipulators

★ Nucleus Dividers

★ Phaco Choppers

Stevenson

Lacrimal Sac Retractor
3 X 3 Blunt Prongs
Self-Retaining Adjustable Spread
AA 1200 / AAD 1200



Stevenson

Lacrimal Sac Retractor
Solid Blades With Serrated Edge
Self-Retaining
Adjustable Spread
AA 1205 / AAD 1205
Size 15mm Blade.



Goldstein

Lacrimal Sac Retractor
3 x 3 Blunt Prongs
AA 1210 / AAD 1210



On Request

Wright

Fascia Needle Size 140mm
AA 1215 / AAD 1215
Sharp Edge



Knapp

Lacrimal Sac Retractor
AA 1220 / AAD 1220 Blunt
Size 1mm Wire x Prongs



Knapp

Lacrimal Sac Retractor
AA 1225 / AAD 1225 Sharp
Size 1mm Wire x Prongs



Jaffe

Wire Lid Retractor
May be Clamped to
Surgical Drape With Suture
or Elastic Band
AA 1230 / AAD 1230 Small. (Pair)
Size 8.5mm Blade
AA 1235 / AAD 1235 Large. (Pair)
Size 14mm Blade.



AA - Stainless Steel, AAT - Titanium, AAD - Disposable Instruments

Clayman

Lid Retractor

Hinged Type

AA 1240 / AAD 1240 Pair

Size 11mm Blade



Dastoor

Iris Retractor

3.5mm Wide Straight

AA 1250 / AAT 1250 / AAD 1250 Straight

AA 1255 / AAT 1255 / AAD 1255 Left

AA 1256 / AAT 1256 / AAD 1256 Right



Desmarres

Lid Retractor

Solid Blades

AA 1260 / AAT 1260 / AAD 1260

Size 0 = 11mm Width

AA 1261 / AAT 1261 / AAD 1261

Size 1 = 12mm Width

AA 1262 / AAT 1262 / AAD 1262

Size 2 = 13mm Width

AA 1263 / AAT 1263 / AAD 1263

Size 3 = 14mm Width

AA 1264 / AAT 1264 / AAD 1264

Size 4 = 15mm Width



Schepens

Forked Orbital Retractor

AA 1270 / AAT 1270 / AAD 1270



Helveston

Tissue Retractor

Thin Curved Blade

AA 1275 / AAT 1275 / AAD 1275 7mm Wide

AA 1276 / AAT 1276 / AAD 1276 9mm Wide



Flieringa

Scleral Fixation Ring

AA 1280 / AAD 1280 Set of 8 Sizes (15-22mm)

AA 1281 / AAD 1281 15mm Dia AA 1285 / AAD 1285 19mm Dia

AA 1282 / AAD 1282 16mm Dia AA 1286 / AAD 1286 20mm Dia

AA 1283 / AAD 1283 17mm Dia AA 1287 / AAD 1287 21mm Dia

AA 1284 / AAD 1284 18mm Dia AA 1288 / AAD 1288 22mm Dia

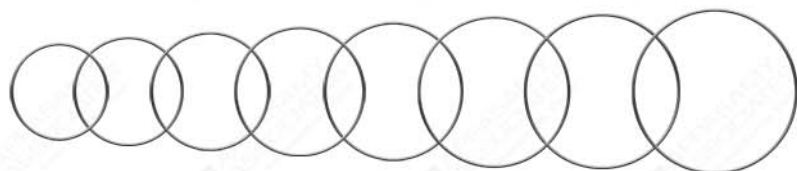

On Request

Goldman

Scleral Fixation Ring
and Blepharostat

AA 1290 / AAD 1290 Adult size

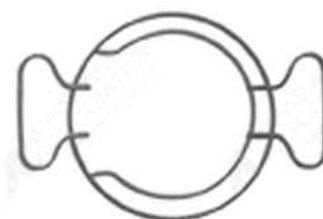

On Request

Gass

Scleral Marker
1.5mm Diameter
Marking Tip

AA 1295 / AAD 1295



Schepens

Scleral Depressor
with thimble

AA 1300 / AAD 1300 Small #8

AA 1305 / AAD 1305 Medium #10

AA 1307 / AAD 1307 Large #12



Lasik

Depressor

Smoothly Adheres Flap to
Stromal Bed in Pupillary Area

AA 1308 / AAT 1308 / AAD 1308

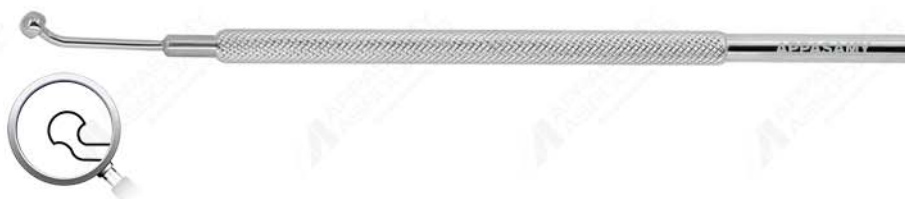

Schocket

Scleral Depressor
Double-End With Pocket Clip
AA 1310 / AAT 1310 / AAD 1310



On Request

Pediatric

Scleral Depressor
AA 1311 / AAD 1311



On Request

Atul's

Pediatric Scleral Depressor
AA 1312 / AAD 1312



Chalazion Knife

Delicate
AA 1315 / AAT 1315 / AAD 1315



Micro Round Knife

for Visco Canalostomy 1.0mm
AA 1316 / AAT 1316 / AAD 1316



Ziegler

Knife Needle
AA 1320 / AAD 1320 3mm
AA 1325 / AAD 1325 5mm



Wheeler

Discission Knife
18mm X 1mm cutting Edge
AA 1330 / AAD 1330



Von Graefe

Cataract Knife
1.5mm X 25mm Sharp Blades
AA 1340 / AAD 1340



AA - Stainless Steel, AAT - Titanium, AAD - Disposable Instruments

Barraquer
Cataract Knife
In Sliding Case
AA 1350 / AAD 1350



On Request

Stiletto Blade
For Micro Vitreo Retinal
Stab incisions, Lancet
Shaped, 20 Gauge
1.0mm Wide
AA 1355 / AAD 1355



On Request

Paufique
Graft Knife
Angled Tip
Curved Cutting Edge
AA 1360 / AAD 1360



Emery
Cystotome
Double-Edge
For Push and Pull Cutting
AA 1365 / AAD 1365 Straight
AA 1366 / AAD 1366 Angled



Tooke
Corneal Knife
Straight Blade With
Curved Cutting Edge
AA 1370 / AAT 1370 / AAD 1370



Gill
Corneal Knife
Curved Cutting Edge
AA 1375 / AAT 1375 / AAD 1375
Straight
AA 1380 / AAT 1380 / AAD 1380
Curved



Rollet Rugine
For Lacrimal Sac
AA 1385 / AAT 1385 / AAD 1385



Paton
Corneal Dissector
Hockey stick knife
AA 1390 / AAT 1390 / AAD 1390



Sato
Corneal Knife
Conical Shaft Straight
AA 1391 / AAT 1391 / AAD 1391
Front 30 G / 0.3mm
Rear 20 G / 0.9mm



Sato
Corneal Knife, Angled
AA 1392 / AAT 1392 / AAD 1392
Front 30 G / 0.3mm
Rear 20 G / 0.9mm



Dastoor
Lacrimal Sac Dissector, Blunt
AA 1395 / AAD 1395



Lang's
Lacrimal Sac Dissector, Sharp
AA 1397 / AAD 1397

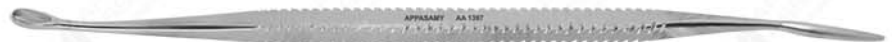

Corneal Dissector
For Intrastromal Dissection
AA 1398 / AAT 1398 / AAD 1398
Angled, Straight Blade
AA 1399 / AAT 1399 / AAD 1399
Angled, Curved Blade
Size 13.5mm Angled & 0.75mm Wide



Ellis
Foreign Body Spud
Very Thin, Lightly,
Curved and Rounded Tip
AA 1400 / AAT 1400 / AAD 1400



Nicati
Foreign Body Spud
AA 1405 / AAT 1405 / AAD 1405



Golf Club
Foreign Body Spud
Angled, Lightly Rounded Tip
AA 1410 / AAT 1410 / AAD 1410



Francis
Foreign Body Spud
Angled, Flag shaped Tip
AA 1415 / AAT 1415 / AAD 1415



Appa - Spud & Gouge
In Reversible Handle
For Removing Foreign Bodies
AA 1420 / AAD 1420

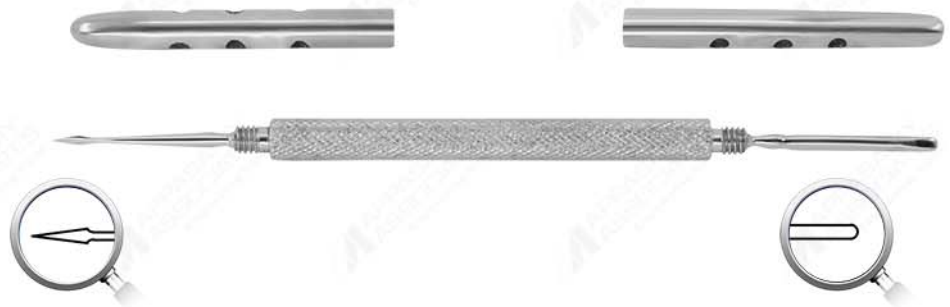

Algerbrush
Corneal Rust
Ring Remover
Battery Powered
AA 1430 Complete
AA 1435 Extra Burr 0.5mm
AA 1440 Extra Burr 1.0mm



On Request

Sinsky II
Lens Manipulating Hook
Blunt Tip, 0.2mm Diameter
AA 1460 / AAT 1460 / AAD 1460
Straight
AA 1465 / AAT 1465 / AAD 1465
Angled



Mahatme

Stop & Chop 1mm Length
Round Handle
0.25mm Diameter Blunt Tip
AA 1466 / AAT 1466 / AAD 1466
Angled



Sinsky

Lens Manipulating Hook
Round Handle
0.25mm Diameter Blunt Tip
AA 1470 / AAT 1470 / AAD 1470
Straight
AA 1472 / AAT 1472 / AAD 1472
Angled

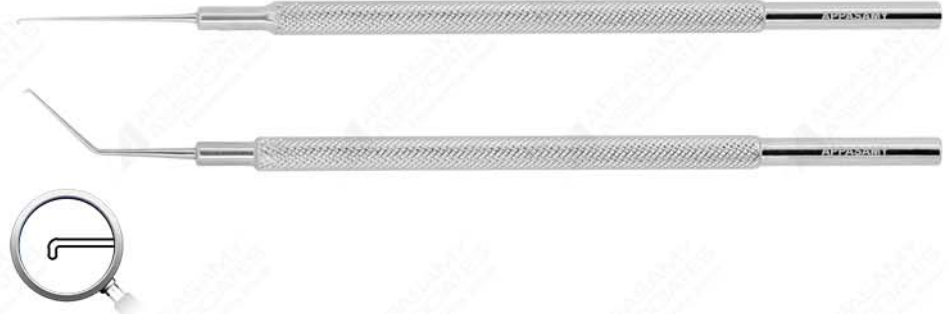

Harris - Sinsky

Lens Manipulating Hook
Blunt tip, 0.25mm Diameter
AA 1475 / AAT 1475 / AAD 1475
Straight
AA 1477 / AAT 1477 / AAD 1477
Angled



Toric Lens Manipulator

Allows Gentle Positioning of the Lens Haptics under the Iris Plane. Tip maximizes surface contact with the lens which allows for easy Manipulation. Posterior Surface Of The Tip is Micro sandblasted to Achieve added surface Contact.
AA 1478 / AAT 1478 / AAD 1478



Rentsch " Boat Hook"

Lens Manipulator, Capsule and Iris Retractor
AA 1480 / AAT 1480 / AAD 1480
Straight



Zaldivar Lens Manipulator

Double ended Instrument With Slight Forked Tips to Place Haptic under the Iris
Round Serrated Handle
AA 1481 / AAT 1481 / AAD 1481



AA - Stainless Steel, AAT - Titanium, AAD - Disposable Instruments

Pallikaris Lens Manipulator

Designed to Place The Haptics Under The Iris.

Round Serrated Handle

AA 1482 / AAT 1482 / AAD 1482



Bahr - Maltzman

No Hole IOL Manipulating Hook
Tip Width 0.80mm

AA 1485 / AAT 1485 / AAD 1485

Angled



Fenzl

Lens Manipulating Hook

Blunt tip, 0.15mm Diameter

AA 1490 / AAT 1490 / AAD 1490

Straight

AA 1495 / AAT 1495 / AAD 1495

Angled



Maltzman-Fenzl

Modified No Hole Lens Manipulator
0.15mm Diameter Tip

AA 1500 / AAT 1500 / AAD 1500

Angled



Jaffe

Lens Manipulating Hook

Blunt Tip, 0.15mm Diameter

Angled to tip 10mm

AA 1505 / AAT 1505 / AAD 1505

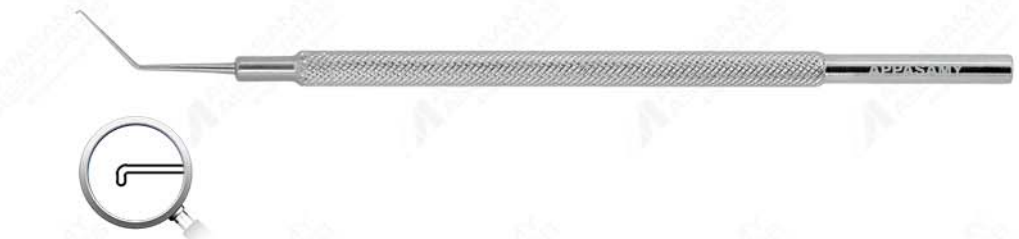

Kuglen

Iris Hook

And Lens Manipulator

Push-Pull Model, Tip width 0.80mm

AA 1510 / AAT 1510 / AAD 1510

Straight

AA 1515 / AAT 1515 / AAD 1515

Angled

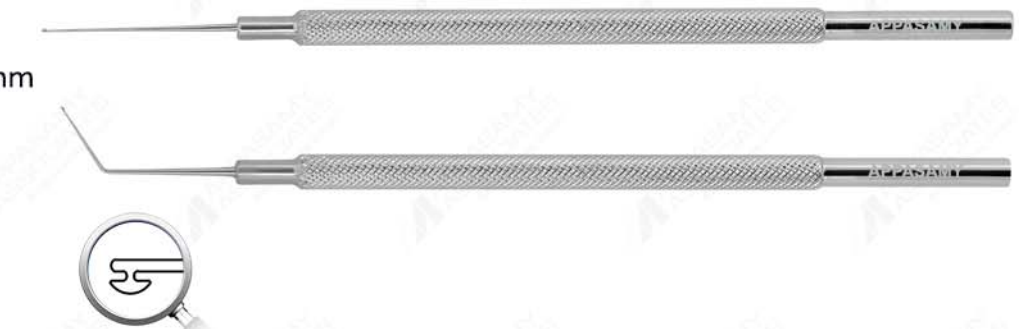

Little

No Hole Lens Manipulator

Tip width 1.20mm

AA 1520 / AAT 1520 / AAD 1520 Straight

AA 1525 / AAT 1525 / AAD 1525 Angled



Lewicky

Lens Manipulating Hook

Blunt tip, 0.15mm Diameter

Angled With Curved Shank

AA 1530 / AAT 1530 / AAD 1530



Kratz

Lens Manipulating Hook

Blunt tip 0.15mm Diameter

Angled to tip 10mm

AA 1535 / AAT 1535 / AAD 1535

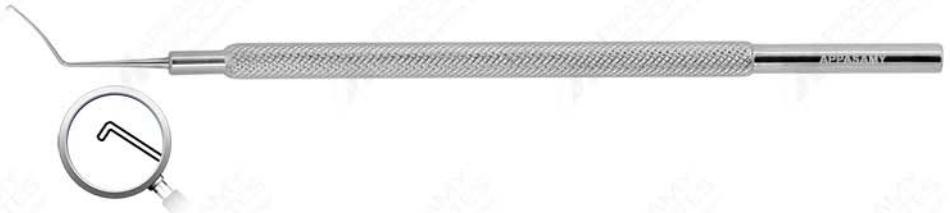

Hessburg

Lens Pusher

AA 1545 / AAT 1545 / AAD 1545

Straight



Aker

Lens Pusher

Smooth, Fish Mouth

Shaped Jaws

AA 1550 / AAT 1550 / AAD 1550

Straight



Lester

Lens Pusher

0.25mm Diameter Tip, Hourglass

Shaped Tip for IOL Manipulation

AA 1555 / AAT 1555 / AAD 1555 Straight

AA 1560 / AAT 1560 / AAD 1560 Angled



Lester
No Hole Lens Manipulator
0.25mm Diameter Tip,
Hourglass Shaped Tip
For IOL Manipulation
AA 1565 / AAT 1565 / AAD 1565
Angled with curved shank



The Lester manipulator features a long, thin, curved shank that angles towards the tip. The tip is hourglass-shaped with a 0.25mm diameter. A circular inset shows a magnified view of the hourglass tip.

Maloney
IOL Manipulator
Vaulted Shank
0.25mm Diameter Tip
AA 1570 / AAT 1570 / AAD 1570



The Maloney manipulator has a long, thin, vaulted shank that curves upwards. The tip is a simple 0.25mm diameter. A circular inset shows a magnified view of the tip.

Lieberman
Micro Finger
Nucleus Manipulator
AA 1575 / AAT 1575 / AAD 1575
Right Handed
AA 1576 / AAT 1576 / AAD 1576
Left Handed



The Lieberman manipulator has a long, thin, curved shank. The tip is a simple 0.25mm diameter. A circular inset shows a magnified view of the tip.

Osher
'Y' Hook No hole
Lens Manipulator
Tip Width 0.6mm Diameter
AA 1580 / AAT 1580 / AAD 1580



The Osher manipulator has a long, thin, straight shank. The tip is a simple 0.6mm diameter. A circular inset shows a magnified view of the tip.

Bechert
Nucleus Rotator
Blunt Forked Tip
Angled to tip 7mm,
Tip width 0.7mm
AA 1590 / AAT 1590 / AAD 1590



The Bechert manipulator has a long, thin, curved shank. The tip is blunt and forked. A circular inset shows a magnified view of the blunt forked tip.

Rana
Phaco-Chopper
For Cracking the Nucleus and
Bring the Nucleus Pieces in the
Center of Pupil
AA 1591 / AAT 1591 / AAD 1591
Size 0.65mm



The Rana manipulator has a long, thin, curved shank. The tip is a simple 0.65mm diameter. A circular inset shows a magnified view of the tip.

Jaffe-Bechert

Nucleus Rotator
Blunt Forked Tip
Angled to tip 9mm
Tip width 0.70mm

AA 1595 / AAT 1595 / AAD 1595



Kelman

Nucleus- Wand
tip Length 12mm, 45° ang tip
For Lens Removal during
Phacoemulsification

AA 1596 / AAT 1596 / AAD 1596



Akahoshi

Nucleus Ball sustainer
is a companion instrument for
Akahoshi Phaco Prechopper.
The delicate Manipulator
is designed to engage
the nucleus Equator to Stabilize
it and provide counter pressure
while the Prechopper Forceps
is being inserted into the Nucleus Core.

AA 1597 / AAT 1597 / AAD 1597



Akahoshi

Nucleus Ring Sustainer
Used to hold the hard Nucleus firmly
during the Prechopping technique
Ring diameter is 1mm,
Angle to tip 2.5mm

AA 1597A / AAT 1597A / AAD 1597A



Caro

Manipulator

AA 1598 / AAT 1598 / AAD 1598



Graether

Side port Manipulator

AA 1599 / AAT 1599 / AAD 1599



Yankee

Nucleus Rotator
1.0mm Diameter

AA 1600 / AAT 1600 / AAD 1600



Connor Wand

Straight Tip Ø 0.5mm

AA 1601 / AAT 1601 / AAD 1601

AA 1601A / AAT 1601A / AAD 1601A

With Irrigation



Connor Wand

Curved Tip Ø 0.5mm

AA 1602 / AAT 1602 / AAD 1602

AA 1602A / AAT 1602A / AAD 1602A

With Irrigation



Connor Wands

Curved Tip Ø 0.5mm

AA 1603 / AAT 1603 / AAD 1603

AA 1604 / AAT 1604 / AAD 1604

With Irrigation



Koch

Phaco Manipulator
and Splitter

0.8mm Width

AA 1605 / AAT 1605 / AAD 1605



Mandel

Nucleus Rotator

AA 1610 / AAT 1610 / AAD 1610

Size 0.60mm

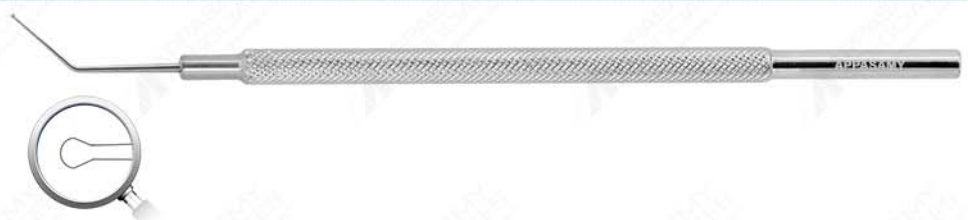

AA - Stainless Steel, AAT - Titanium, AAD - Disposable Instruments

Siepsner

Endocapsular Controller
Trumpet Shaped Tip

AA 1612 / AAT 1612 / AAD 1612



Pisacano Hook

Nucleus Rotator
Flat Disc Shaped Tip

AA 1613 / AAT 1613 / AAD 1613

Horizontal

AA 1614 / AAT 1614 / AAD 1614

Vertical

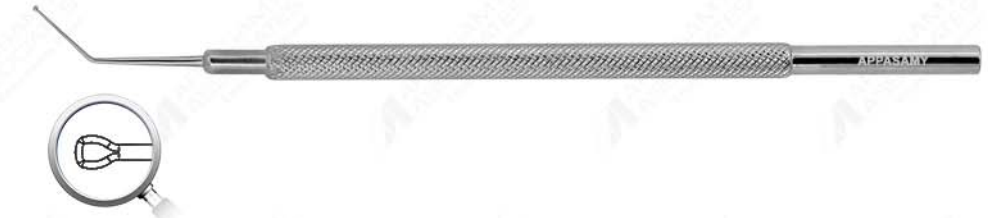

Kellan

Nucleus Segmentor
Paddle Shaped to Split Nucleus

AA 1615 / AAT 1615 / AAD 1615



Tennant

Nucleus Manipulator
Ball Shaped Tip

AA 1620 / AAT 1620 / AAD 1620



Sinskey - Kuglen

For Hole & No Hole
Lens Manipulator

AA 1621 / AAT 1621 / AAD 1621



Arul - Sinskey

Lens Manipulator Hook
Blunt tip 0.2mm Dia &
Phaco Chopper Blunt Ball Tip
45° Angled

AA 1622 / AAT 1622 / AAD 1622



Chang-Seibel

Phaco Chopper
A Combination chopper with the
Chang Micro Finger End and the
Seibel Vertical Safety Chopper

AA 1623 / AAT 1623 / AAD 1623



AA - Stainless Steel, AAT - Titanium, AAD - Disposable Instruments

Arul-Agarwal
Double End Phaco Chopper

Blunt Ball Tip 45° Angled
and Fully Cutting Edge

AA 1624 / AAT 1624 / AAD 1624

Arul - 1.0mm Inner Cutting Edge,
0.25mm Blunt Polished Tip

Agarwal - 1.0mm Inner Cutting Edge



Maloney

'Y' Pusher & Rod Tip
For Manipulating Hard
And Soft Nucleic.

AA 1625 / AAT 1625 / AAD 1625



Appasamy

Plain Rod 11mm Angled
For IRIS Claw Lens Surgery / Phacic IOL
AA 1625A / AAT 1625A / AAD 1625A
Size 0.5mm Dia



Chang Quick Chop Combo

This Double End Instrument Features
Micro finger And pointed
"Quick Chop" tip. Micro finger tip
for Chopping & Dividing the Nucleus
and "Quick Chop" Tip For Split the Nucleus

AA 1626 / AAT 1626 / AAD 1626



Arul-Bechert

Double End
Phaco Chopper
Blunt Ball Tip 45° Angled & 'Y' Rotator

AA 1627 / AAT 1627 / AAD 1627



Arul-Bechert

Double End
Chopper Fully Cutting Edge & 'Y' Rotator

AA 1628 / AAT 1628 / AAD 1628



Barrett Duo

Phaco Chopper & Manipulator

AA 1629 / AAT 1629 / AAD 1629

1.0mm Inner Cutting edge,
Polished Tip 0.25mm & 0.8mm Dia



Maloney Nucleus

Nucleus Rotator With
Spatulated Tip for
Manipulation Hard and Soft Nuclic

AA 1630 / AAT 1630 / AAD 1630

Size 0.65mm & 0.80mm



Thomas Neuhann

'Y' Rotator & Phaco Splitter

AA 1631 / AAT 1631 / AAD 1631

Size 0.70mm &
1.00mm Inner Cutting edge, 1.3mm Tip



Thomas Neuhann

Iris Hook & Nucleus Splitter

AA 1632 / AAT 1632 / AAD 1632

Size 0.75mm Tip &
1.0mm Inner Cutting Edge, 1.3mm Tip



Masket Phaco Spatula

Nucleus Chopper & Manipulator

AA 1633 / AAT 1633 / AAD 1633

Size 1.0mm Dia &
1.0mm Inner Cutting Edge, 1.35mm Tip



Katzen

For Lasik Enhancements
This Double End Instrument
combines sinskey lens
manipulating hook and
biconvex spatula wire
Bended Notches

AA 1634 / AAT 1634 / AAD 1634



AA - Stainless Steel, AAT - Titanium, AAD - Disposable Instruments

Kellan

Nucleus Rotator
and IOL Guide

AA 1635 / AAT 1635 / AAD 1635



Sinskey - Drysdale

Lens Manipulating Hook and
Nucleus Manipulator

AA 1636 / AAT 1636 / AAD 1636

Size 0.2mm Dia & 1.5mm Tip



Drysdale

Nucleus Manipulator

AA 1636A / AAT 1636A / AAD 1636A

Size 1.0mm Tip



Pettigrove

PRK Scraper and Marker
6.5mm Marker & Spatula
For Both Marking and Removing
the Epithelium prior to PRK

AA 1637 / AAT 1637 / AAD 1637

Size 0.65mm Dia & 2.25mm Width, 7.0mm Length



Machat

Double Ended
Intralase Spatula With 45° Sinskey

AA 1638 / AAT 1638 / AAD 1638



Lasik Flap Lifter

Combines a 45° Angled Sinskey
Hook and a Thin Hook With a
Conical tip

AA 1639 / AAT 1639 / AAD 1639



Hirschman

Lens Spatula

Flat, 0.5mm Wide

With Small Notches for the
Manipulating IOLs

AA 1640 / AAT 1640 / AAD 1640



Iris spatula

Malleable Stainless Steel Spatula
1mm Wide Blade

AA 1650 / AAT 1650 / AAD 1650



Barraquer

Iris Spatula

Round Handle, Smooth Angled

Tip Width 0.25mm Dia & 13mm Length

AA 1655 / AAT 1655 / AAD 1655

Tip Width 0.50mm Dia & 13mm Length

AA 1656 / AAT 1656 / AAD 1656



Troutman - Barraquer

Iris Spatula

Angle to tip 15mm Length &

Tip Width 0.5mm Dia

AA 1660 / AAT 1660 / AAD 1660



Fukasaku

Lasik Spatula

for Lifting and Dissecting

The Corneal Flap

AA 1665 / AAT 1665 / AAD 1665

Size 0.3mm Thickness, 10mm Length



Slade Femtosecond Spatula

Flat Tip Used to Open The Main and
Side Port Incisions, Made for
Femtosecond Laser Procedure

AA 1666 / AAT 1666 / AAD 1666

Size 0.25mm Width, 10mm Length



Castroviejo

Synechiae Spatula
Double-Ended, 0.5mm Wide
With Semi-Sharp Tip
AA 1670 / AAT 1670 / AAD 1670



Girard

Synechiae Spatula
Semi-sharp Tip
0.5mm Wide, Angled
AA 1675 / AAT 1675 / AAD 1675



Obstbaum

Lens Spatula Angled
0.25mm Wide Blade
AA 1677 / AAT 1677 / AAD 1677



Castroviejo

Cyclodialysis Spatula
Double-Ended
AA 1680 / AAT 1680 / AAD 1680
0.25mm Wide
AA 1682 / AAT 1682 / AAD 1682
0.50mm Wide



Slade

Lasik Retreatment Spatula
Tip Width 1.6mm Wide
AA 1683 / AAT 1683 / AAD 1683



Koman Nair

Iris Spatula, Double Ended
Smooth 1mm Wide X 10mm Long
Angled and 1mm Wide 30mm
Long Gently Curved Shaft
AA 1685 / AAT 1685 / AAD 1685



Castroviejo

Corneal Transplant
Spatula, Double-Ended

AA 1690 / AAT 1690 / AAD 1690



Dastoor

Pupil and Iris Repositor

AA 1695 / AAT 1695 / AAD 1695



Busin

Endothelial Glide
Funnel-Shaped Spatula Cut-Out
Notch At Tip

AA 1696 / AAT 1696 / AAD 1696

Size 4.5mm Width



Green

Spatula
Double-Ended
Long Handle

AA 1700 / AAT 1700 / AAD 1700



Jaffe

Lens Spatula
Flat, Smooth
0.5mm Wide

AA 1705 / AAT 1705 / AAD 1705



Paton

Spatula & Spoon

AA 1710 / AAT 1710 / AAD 1710



AA - Stainless Steel, AAT - Titanium, AAD - Disposable Instruments

Nordan

Capsule Elevator
for In-The Bag
IOL Placement

AA 1715 / AAT 1715 / AAD 1715



Wheeler

Double-Ended Spatula
Lightly Curved

AA 1720 / AAT 1720 / AAD 1720



Kimura

Platinum Spatula

AA 1725 / AAT 1725 / AAD 1725



Wecker

Iris Spatula 1mm Wide,
30mm Long Curved Shaft

AA 1730 / AAT 1730 / AAD 1730



Knolle

Lens Nucleus Spatula
Lightly Curved, Malleable Tip

AA 1735 / AAT 1735 / AAD 1735

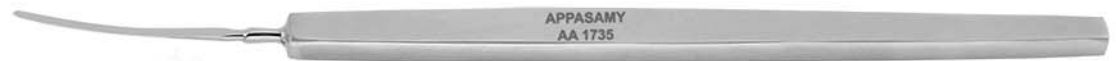

Jaeger

Lid Plate

AA 1740 / AAT 1740 / AAD 1740



AA - Stainless Steel, AAT - Titanium, AAD - Disposable Instruments

Stallard

Ptosis Spatula

AA 1745 / AAD 1745 Small

AA 1746 / AAD 1746 Large



Graether

Collar Button

Micro Iris Retractor

AA 1750 / AAT 1750 / AAD 1750

Straight, Tip Size 0.75mm

AA 1755 / AAT 1755 / AAD 1755

Angled, Tip Size 0.75mm



Bonn

Micro Iris Hook

Blunt Tip

AA 1760 / AAT 1760 / AAD 1760

Round handle

AA 1765 / AAT 1765 / AAD 1765

Flat handle

Size 1.2mm, 0.25mm Thickness



Jaffe-Knolle

Iris Hook

Very Blunt

Small, Angled

AA 1770 / AAT 1770 / AAD 1770

Size 1.5mm, 0.25mm Dia



Knolle

Iris Hook

Very Blunt, Straight

AA 1775 / AAT 1775 / AAD 1775

Size 1.5mm, 0.25mm Dia



Shepard

Iris Hook Small

Blunt, Flat Handle

AA 1780 / AAT 1780 / AAD 1780



AA - Stainless Steel, AAT - Titanium, AAD - Disposable Instruments

Jaffe

Iris Hook Small, Blunt / Flat handle
AA 1790 / AAT 1790 / AAD 1790



Kuglen

Iris Hook and Lens Manipulator
Clover Leaf Model
AA 1800 / AAT 1800 / AAD 1800
Straight



Twist Hook

For Scleral Fixation
AA 1805 / AAD 1805



Fixation Hook

Double, Sharp
AA 1810 / AAD 1810
2 X 1.5mm Small
AA 1812 / AAD 1812
2.5 X 2mm Large



Thornton

Globe Fixation Ring
Multiple Teeth
16mm Diameter
AA 1815 / AAT 1815 / AAD 1815



Thornton

Globe Fixation Ring
Multiple Teeth
16mm Diameter, 6mm Front Opening
AA 1816 / AAT 1816 / AAD 1816



Shepard

Fixation Ring
Clear Cornea Incision
12 Teeth, Pivot Swivelable, Openings
16mm Diameter, 6mm Front Opening
AA 1817 / AAT 1817 / AAD 1817



AA - Stainless Steel, AAT - Titanium, AAD - Disposable Instruments

Appasamy

Globe Fixation Ring with Concentric Grooves for Stabilizing the Globe During PRK and LASIK Procedures.

AA 1818 / AAD 1818

Size Outer Dia 15.75mm, Inner Dia 10.25mm



On Request

Appasamy

Globe Fixation Ring with Concentric Grooves for Stabilizing the Globe and Providing Counterpressure for Clear Cornea Phaco Incisions and IOL Insertion.

AA 1819 / AAD 1819

Size Outer Dia 15.5mm, Inner Dia 10.25mm, Open 2.3mm



On Request

Stevens

Tenotomy Hook
Blunt, Small

AA 1820 / AAT 1820 / AAD 1820

Size Tip Length 7.5mm



Graefe

Muscle Hook

AA 1825 / AAT 1825 / AAD 1825 Size 1

AA 1826 / AAT 1826 / AAD 1826 Size 2

AA 1827 / AAT 1827 / AAD 1827 Size 3

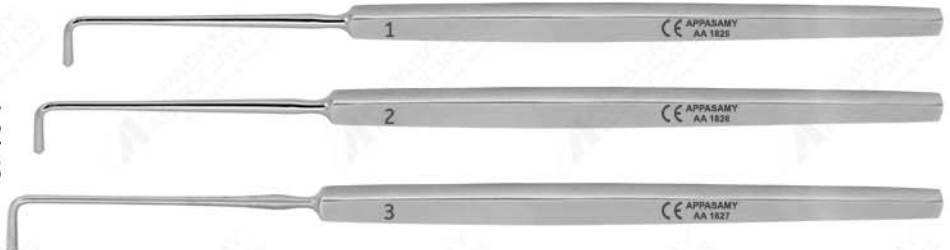

Gass

Retinal Detachment Hook
With Oval Hole

AA 1830 / AAT 1830 / AAD 1830



Jameson

Muscle Hook

AA 1835 / AAT 1835 / AAD 1835 Small

AA 1837 / AAT 1837 / AAD 1837 Large



MUSCLE HOOKS & LENS EXPRESSORS

Green
Muscle Hook
AA 1840 / AAT 1840 / AAD 1840



Arruga
Lens Extractor
AA 1845 / AAT 1845 / AAD 1845 Right
AA 1846 / AAT 1846 / AAD 1846 Left



Chavasse
Muscle Hook
AA 1850 / AAT 1850 / AAD 1850



Culler
Rectus Muscle Hook
AA 1855 / AAT 1855 / AAD 1855



Smith
Lens Expressor
AA 1860 / AAT 1860 / AAD 1860



Appasamy
Lens Expressor
Double-Ended
AA 1862 / AAT 1862 / AAD 1862

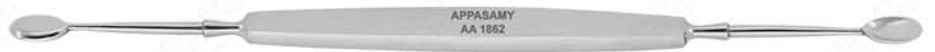

Kirby
Lens Expressor & Vectis
AA 1865 / AAT 1865 / AAD 1865



Kirby
Muscle Hook & Vectis
AA 1865A / AAT 1865A / AAD 1865A



AA - Stainless Steel, AAT - Titanium, AAD - Disposable Instruments

LENS EXPRESSORS, CRUETTES & SPOONS

Kirby

Lens Expressor & Repositor

AA 1866 / AAT 1866 / AAD 1866



Kirby

Lens Expressor & Spatula

AA 1867 / AAT 1867 / AAD 1867



Kirby

Iris Retractor & Repositor

AA 1868 / AAT 1868 / AAD 1868

Size 0.25mm, 3.5mm



Meyerhoefer

Chalazion Curette

AA 1875 / AAT 1875 / AAD 1875

Size 0, 1.50mm Dia



AA 1876 / AAT 1876 / AAD 1876

Size 1, 1.75mm Dia



AA 1877 / AAT 1877 / AAD 1877

Size 2, 2.25mm Dia



AA 1878 / AAT 1878 / AAD 1878

Size 3, 3.00mm Dia



AA 1879 / AAT 1879 / AAD 1879

Size 4, 3.50mm Dia



Bunge

Evisceration Spoon

AA 1880 / AAT 1880 / AAD 1880

Small, Size 8.45mm Dia

AA 1881 / AAT 1881 / AAD 1881

Large, Size 8.5mm Dia



AA - Stainless Steel, AAT - Titanium, AAD - Disposable Instruments

SPOONS & POLISHERS

Mule

Evisceration Scoop

AA 1885 / AAT 1885 / AAD 1885 Small
AA 1886 / AAT 1886 / AAD 1886 Large



Wells

Enucleation Spoon

AA 1890 / AAT 1890 / AAD 1890 Small
AA 1891 / AAT 1891 / AAD 1891 Large



Mc Intyre

Nucleus Removal Cannula
With Irrigation Port

AA 1895 / AAD 1895
Size 2.5 mm Width, 16G



Daviel

Lens Spoon

AA 1900 / AAT 1900 / AAD 1900 Small
AA 1901 / AAT 1901 / AAD 1901 Big



Barraquer

Lenticular Spoon
for Corneal Button Transfer

AA 1905 / AAD 1905
Size 9mm, 5 Holes 1.5mm Dia.



Anis

Capsule Scrubber
Gently Curved Flexible Shank
With Roughened Tip

AA 1906 / AAD 1906 Ball Tip, 0.75mm
AA 1907 / AAD 1907 Disc Tip, 1.75mm
AA 1908 / AAD 1908 Reverse Ball Tip



AA - Stainless Steel, AAT - Titanium, AAD - Disposable Instruments

POLISHERS & LENS LOOPS

Nightingale

Capsule Polisher

1.75mm Dia. Open ring

Semi-Sharp Edge

AA 1910 / AAT 1910 / AAD 1910

Anterior

AA 1911 / AAT 1911 / AAD 1911

Posterior

AA 1912 / AAT 1912 / AAD 1912

12'O Clock

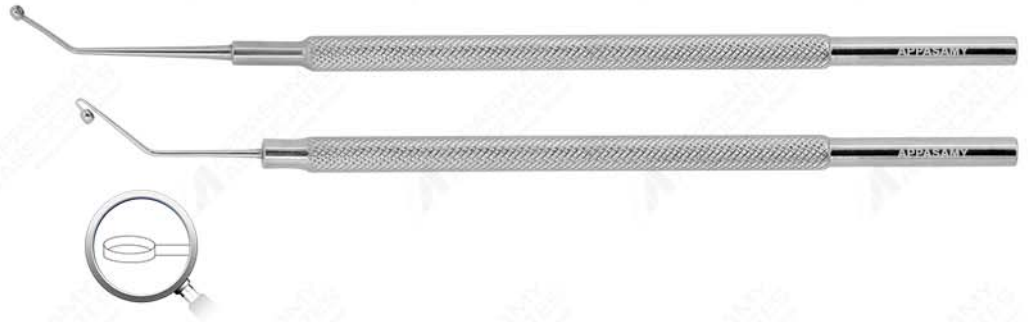

Lewis

Lens Loop

AA 1914 / AAT 1914 / AAD 1914

Extra Small, 4.0mm Width

AA 1915 / AAT 1915 / AAD 1915

Small, 5.0mm Width

AA 1915A / AAT 1915A / AAD 1915A

Angled, 5.0mm Width

AA 1916 / AAT 1916 / AAD 1916

Large, 6.0mm Width



Appa - Snare

Nucleus Dividing Snare

AA 1917 / AAT 1917 / AAD 1917

Complete Set

AA 1918 / AAT 1918 / AAD 1918

Apare Snare (pkd/5)

Size 5.0mm Width, 0.2mm Thickness

On Request



New Orleans

Lens Loop

AA 1920 / AAT 1920 / AAD 1920

Size 3.5mm Width



Wilder

Lens Loop

AA 1925 / AAT 1925 / AAD 1925

Serrated

Size 3.0mm Width



AA - Stainless Steel, AAT - Titanium, AAD - Disposable Instruments

LENS LOOPS & CAUTERY

Kansas

Lens Loop 3mm Wide
Serrated for Small Incision
Nucleus Fragment Removal
AA 1930 / AAT 1930 / AAD 1930
Medium Curved



Keener-Arzt

Lens Loop
3mm Wide Serrated Strong
Curve for Small
Incision Nucleus
Fragment Removal
AA 1935 / AAT 1935 / AAD 1935

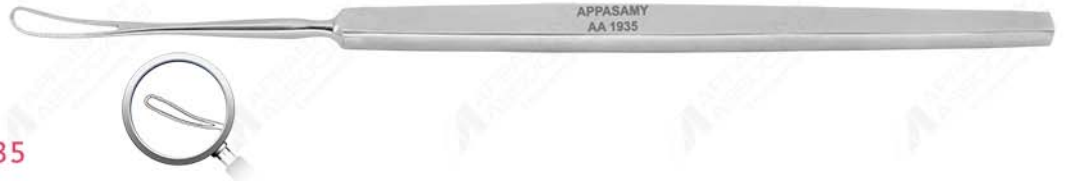

Akahoshi/Wahab Pars Plana Levitator

Can be used to Lift the
Nucleus from the Retina
20 Gauge Loop
Dimensions 12mm
AA 1936 / AAT 1936 / AAD 1936



Gills-Welsh

Lens Loop and Probe
With Serrations
AA 1940 / AAT 1940 / AAD 1940
Size 6.0mm Width



Morrison

Lens Loop and Probe
Very Thin
AA 1945 / AAT 1945 / AAD 1945
Size 4.5mm Width, 1.7mm Dia



Simcoe

Lens Nucleus Loop
Fine Serrations, Strong Curve
Double-End
AA 1950 / AAT 1950 / AAD 1950
Size 4.0mm Width



Cautery Ball Point
Stainless Steel
AA 1960 / AAD 1960



Cautery Ball Point
Copper
AA 1961 / AAD 1961



AA - Stainless Steel, AAT - Titanium, AAD - Disposable Instruments

CAUTERY & NUCLEUS DIVIDERS

Cautery Cone Type
Stainless Steel
AA 1962 / AAD 1962



Cautery Cone Type
Copper
AA 1963 / AAD 1963



Kansas
Nucleus Bisector
for Manual Small Incision Surgery
AA 1965 / AAT 1965 / AAD 1965
Size 11.0mm Length, 1.0mm Thickness



Alfonso
Nucleus Trisector
1.5mm Wide Used With
AA 1967 Alfonso Cutting
Platform For manual
Small Incision Surgery
AA 1966 / AAD 1966



Alfonso
Cutting Platform
Used as a Cutting Block
for Nucleus Trisector
For Manual Small Incision
Surgery, 2mm Wide
AA 1967 / AAD 1967



Kansas
Nucleus Trisector
For Manual Small Incision Surgery
AA 1970 / AAD 1970 Right
AA 1972 / AAD 1972 Left
Size 4.0mm Wide, 10.0mm Length



Ravisankar
Nucleus Trisector
9mm Length,
2.5mm Wide
AA 1973 / AAD 1973



AA - Stainless Steel, AAT - Titanium, AAD - Disposable Instruments

NUCLEUS DIVIDERS & PHACO CHOPPERS

Ravisankar

Nucleus Vectis Serrated
9mm Length, 2.5mm Wide
AA 1974 / AAT 1974 / AAD 1974



Kansas

Nucleus Vectis Solid, Used
as a "Cutting Block" for
Kansas Nucleus
Bisector and Trisector
AA 1975 / AAT 1975 / AAD 1975 Right
AA 1977 / AAT 1977 / AAD 1977 Left
Size 15.0mm Length, 3.0mm Wide



Mc Intyre

Nucleus Bisector
For Small Incision Surgery
AA 1980 / AAD 1980 Right
AA 1981 / AAD 1981 Left
Size 0.05mm Cutting Edge and Side, 1.8mm Tip



Mc Intyre

Nucleus Trisector
For Small Incision Surgery
AA 1982 / AAD 1982 Right
AA 1984 / AAD 1984 Left
Size 3.0mm Width, 12.0mm Length



Mc Intyre

Nucleus Vectis
Solid, used as a "cutting block"
for Mc Intyre Nucleus
Bisector and Trisector
AA 1985 / AAD 1985 Right
AA 1987 / AAD 1987 Left



Chang

Micro Finger Phaco Chopper
Delicate Micro Finger and is
used for the Division of Medium
to Soft Nuclei the Finger Shaped
tip is used to Split the Nucleus
Horizontally.
AA 1988 / AAT 1988 / AAD 1988
Size 0.3mm Tip, 2.0mm Length



PHACO CHOPPERS

Mohan Rajan

Micro Combo Chopper

Pointed Tips

Vertical Nucleus Chopper

AA 1989 / AAT 1989 / AAD 1989 1.00mm

AA 1989A / AAT 1989A / AAD 1989A 1.25mm

AA 1989B / AAT 1989B / AAD 1989B 1.50mm

AA 1989C / AAT 1989C / AAD 1989C 1.75mm

AA 1989D / AAT 1989D / AAD 1989D 2.00mm



Arul

Phaco Chopper

1.0mm Inner Cutting Edge

0.25mm Blunt Polished Tip

AA 1990 / AAT 1990 / AAD 1990 15° Angle

AA 1991 / AAT 1991 / AAD 1991 45° Angle

AA 1992 / AAT 1992 / AAD 1992 60° Angle



Agarwal

Phaco Chopper

Vertical Nucleus Chopper

Fully Cutting Edge

AA 1993 / AAT 1993 / AAD 1993 1.00mm

AA 1993A / AAT 1993A / AAD 1993A 1.25mm

AA 1993B / AAT 1993B / AAD 1993B 1.50mm



Verges

Phaco Chopper

Triple Cutting Edge

1.0mm Inner Cutting Edge

0.25mm Blunt Polished Tip

AA 1994 / AAT 1994 / AAD 1994



Appasamy

Phaco Chopper & Iris Retractor

2mm Cutting Edge

Blunt Tip, 10° Angle

AA 1995 / AAT 1995 / AAD 1995



Rosen

Phaco Splitter

Inner Cutting Edge & Smooth Blunt Tip

AA 1996 / AAT 1996 / AAD 1996

Size 0.15mm Tip, 0.35mm Dia



AA - Stainless Steel, AAT - Titanium, AAD - Disposable Instruments

PHACO CHOPPERS

Miyoshi

Nucleus Dividing Hook
For Fine Cutting

AA 1997 / AAT 1997 / AAD 1997 Straight
Size 1.3mm length, 0.4mm Tip



Miyoshi

Nucleus Dividing Hook
For Use With the Right Hand

AA 1998 / AAT 1998 / AAD 1998 Right
Size 1.3mm length, 0.4mm Tip



Miyoshi

Nucleus Dividing Hook
for use With the Left Hand

AA 1999 / AAT 1999 / AAD 1999 Left
Size 1.3mm length, 0.4mm Tip



Nagahara

Karate Chopper
Tip Length 1.5mm
Spear Shaped for Ease of
Insertion into the Nucleus

AA 2000 / AAT 2000 / AAD 2000
AA 2000A / AAT 2000A / AAD 2000A
For Left Hand Surgeon
AA 2000B / AAT 2000B / AAD 2000B
For Right Hand Surgeon



Gillum

Side Port Splitter
Tip Length 1.5mm
Angled shaft 'C' Shape for
Entry from the Side Port,
Overall Size 120mm

AA 2001 / AAT 2001 / AAD 2001



Gillum

Phaco Splitter
Tip Length 1.5mm
Angled Shaft 'S' Shape for
Entry from the Tunnel Incision
Overall Size 120mm

AA 2002 / AAT 2002 / AAD 2002



AA - Stainless Steel, AAT - Titanium, AAD - Disposable Instruments

PHACO CHOPPERS

Steinert

Nucleus Chopper

Curved Tip Length 1.5mm

AA 2003 / AAT 2003 / AAD 2003



Mackool

Phaco Chopper

Delicate Rounded Tip

AA 2004 / AAT 2004 / AAD 2004

Size 1.0mm Length



Seibel

Phaco Chopper

AA 2005B / AAT 2005B / AAD 2005B

Right Hand

AA 2005D / AAT 2005D / AAD 2005D

Left Hand

Size 1.5mm Length, 0.5mm Tip



Minu Mathen

Universal Chopper

AA 2008 / AAT 2008 / AAD 2008

1mm Tip

AA 2008A / AAT 2008A / AAD 2008A

1.25mm Tip

AA 2008B / AAT 2008B / AAD 2008B

1.5mm Tip

AA 2008C / AAT 2008C / AAD 2008C

1.75mm Tip

AA 2008D / AAT 2008D / AAD 2008B

2mm Tip



Minu Mathen

Tunnel Chopper

AA 2009 / AAT 2009 / AAD 2009

Size 1.0mm Length, 0.25mm Tip



AA - Stainless Steel, AAT - Titanium, AAD - Disposable Instruments

★ Corneal Trephines

★ Calipers

★ Markers

★ Lasek Instruments

★ Lasik Instruments

★ Dsek Instruments

★ Membrane Spatula

Castroviejo

Corneal Trephine
With Adjustable Stop

AA 2010 / AAD 2010 Size 5mm Dia.
AA 2011 / AAD 2011 Size 5.5mm Dia.
AA 2012 / AAD 2012 Size 6mm Dia.
AA 2013 / AAD 2013 Size 6.5mm Dia.
AA 2014 / AAD 2014 Size 7mm Dia.
AA 2015 / AAD 2015 Size 7.5mm Dia.
AA 2016 / AAD 2016 Size 8mm Dia.
AA 2017 / AAD 2017 Size 8.5mm Dia.

AA 2018 / AAD 2018 Size 9mm Dia.
AA 2019 / AAD 2019 Size 9.5mm Dia.
AA 2020 / AAD 2020 Size 10mm Dia.
AA 2020A / AAD 2020A Size 10.5mm Dia.
AA 2021 / AAD 2021 Size 11mm Dia.
AA 2022 / AAD 2022 Size 1.5mm Dia.
AA 2023 / AAD 2023 Size 12mm Dia.
AA 2024 / AAD 2024 Size 12.5mm Dia.



Appasamy

Corneal Trephine
See Through

AA 2024A / AAD 2024A Size 5.5mm Dia.
AA 2025 / AAD 2025 Size 6mm Dia.
AA 2025A / AAD 2025A Size 5.75mm Dia.
AA 2025B / AAD 2025B Size 6.25mm Dia.
AA 2026 / AAD 2026 Size 6.5mm Dia.
AA 2027 / AAD 2027 Size 7mm Dia.
AA 2028 / AAD 2028 Size 7.5mm Dia.

AA 2029 / AAD 2029 Size 8mm Dia.
AA 2030 / AAD 2030 Size 8.5mm Dia.
AA 2031 / AAD 2031 Size 9mm Dia.
AA 2032 / AAD 2032 Size 9.5mm Dia.
AA 2033 / AAD 2033 Size 10mm Dia.
AA 2033A / AAD 2033A Size 10.5mm Dia.
AA 2034 / AAD 2034 Size 11mm Dia.



Barraquer

Keratoplasty Knife
Pear-Shaped

AA 2035 / AAT 2035 / AAD 2035



Dastoor

Keratoplasty Spatula

AA 2040 / AAT 2040 / AAD 2040



Tudor Thomas

Corneal Graft Stand
Brass Chrome Plated

AA 2050 / AAD 2050

On Request



(Reduced Image Shown)

Lieberman

Corneal Cutting Block
With Hole in the Center for Release of Air
and Fluid Underneath the Donor Button

AA 2060 / AAD 2060 Teflon

AA 2061 / AAD 2061 Silicone



AA - Stainless Steel, AAT - Titanium, AAD - Disposable Instruments

DMEK Twin Block

Twin Block

Block consists of Twin Wells Specially Designed to Hold the Donor Cornea and help Surgeon in the Donor Tissue Preparation.

AA 2062 / AAD 2062



On Request

Appasamy

Corneal Transplant Punch

This Punch Produces a Symmetrical Smooth, Vertical Cut When using a Appasamy Trephine Blade. The Base of Punch is Provided with a Cavity to Hold The Silicone Block in the Centre

AA 2065 / AAD 2065



(Reduced Image Shown)

On Request

Dastoor

Corneal Graft Holding Forceps

AA 2070 / AAD 2070



Castroviejo

Caliper

20mm Spread

AA 2075 / AAT 2075 / AAD 2075 Straight

AA 2080 / AAT 2080 / AAD 2080 Curved

AA 2081 / AAT 2081 / AAD 2081 Angled



On Request

Osher

Incision Caliper

for Internal Measurement of Cataract Incisions From 1 to 10mm

AA 2085 / AAD 2085



Appasamy

Fixed Caliper Double End

AA 2086 / AAD 2086

Size 2.8 & 5.00mm

AA 2087 / AAD 2087

Size 3.0 & 3.50mm

AA 2087A / AAD 2087A

Size 3.0 & 5.20mm

AA 2088 / AAD 2088

Size 3.2 & 5.50mm

AA 2088A / AAD 2088A

Size 3.5 & 4.00mm

AA 2088B / AAD 2088B

Size 3.8 & 5.20mm

AA 2089 / AAD 2089

Size 5.5 & 6.00mm



AA - Stainless Steel, AAT - Titanium, AAD - Disposable Instruments

Galand

Incision Marker

AA 2090 Size 3mm Dia.

AA 2091 Size 3.5mm Dia.

AA 2092 Size 4mm Dia.

AA 2093 Size 4.5mm Dia.

AA 2094 Size 5mm Dia.

AA 2095 Size 5.5mm Dia.

AA 2096 Size 6mm Dia.

AA 2097 Size 6.5mm Dia.

AA 2098 Size 7mm Dia.

AA 2099 Size 7.5mm Dia.

AA 2100 Size 8mm Dia.



Appasamy

Incision Gauge For Measuring the Incision Size, During Phaco Surgery (0.80mm to 3.2mm)

0.1mm Increments, Set of 24 Gauges

AA 2102 / AAD 2102

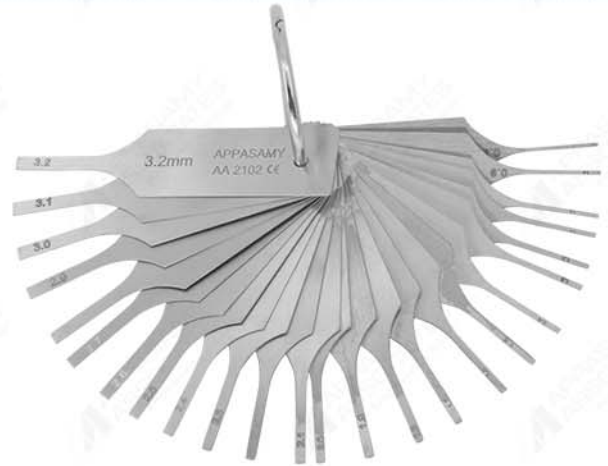

Thorpe

Caliper

With Markings

in 0.5mm Increments

AA 2105 / AAD 2105

On Request



Jameson

Caliper

Chrome Plated Brass

AA 2110 / AAD 2110

On Request



Rule

Stainless Steel

AA 2115 / AAD 2115



AA - Stainless Steel, AAT - Titanium, AAD - Disposable Instruments

Stahl

On Request

Anterior Chamber Caliper
for Measuring Corneal
Diameter "white to white"
Size Markings on Both Sides
AA 2120 / AAD 2120

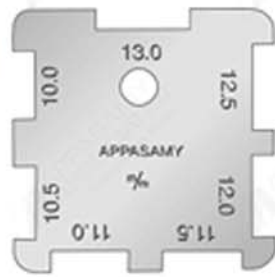

Blade Gauge

For Verification
of Blade Extension
in 20 Micron Increments
AA 2122 / AAD 2122

On Request



Deitz

Incision Depth Gauge
for Corneal Incisions
AA 2125 / AAT 2125 / AAD 2125
0.50mm
AA 2127 / AAT 2127 / AAD 2127
0.55mm



Thornton

Limbal Incision Ruler
With Marking Lines
Spaced 1mm Apart
AA 2130 / AAD 2130



Grandon

T-Incision Single Marker
AA 2135 / AAD 2135 2.00mm Wide
AA 2136 / AAD 2136 2.50mm Wide
AA 2137 / AAD 2137 3.00mm Wide
AA 2138 / AAD 2138 4.00mm Wide
AA 2139 / AAD 2139 5.00mm Wide



Mendez

Degree Gauge
for Accurate Axial
Alignment of Corneal
Incision to Correct
Astigmatism 12mm I.D.
AA 2140 / AAT 2140 / AAD 2140



Appasamy

Fixation Ring &
Degree Gauge
For Globe Fixation and
Alignment of Corneal
Incision 12mm I.D., 17.5mm O.D.
(With Teeth)
AA 2141 / AAD 2141



AA - Stainless Steel, AAT - Titanium, AAD - Disposable Instruments

Appasamy

Fixation Ring and Degree Gauge
For Globe Fixation and Alignment of Corneal Incision 12mm I.D., 17.5mm O.D (With Teeth)

AA 2142 / AAD 2142
Handle in 90° Position For Temporal Approach



Irrigating Marker

Suitable for ICSR Surgery
AA 2144 / AAD 2144



Bores

Axis Marker
Used With Mendez Degree Gauge to Mark the Axis in Which Corneal Incisions for Correction of Astigmatism are to be Made
AA 2145 / AAD 2145



Tunnel Zone Marker

Marking Tunnel for Future Ring Position With Initial Lines for Incisions
140 Degree Angled to Handle
AA 2146 / AAT 2146 / AAD 2146 7.2mm
AA 2147 / AAT 2147 / AAD 2147 8.0mm
Size 2.0mm Ring Height



Nordan-Ruiz

Trapezoidal Marker
For Surgical Correction of Astigmatism
Blades Spaced 1mm Apart
AA 2150 / AAD 2150 2.50mm Wide
AA 2151 / AAD 2151 3.00mm Wide
AA 2152 / AAD 2152 4.00mm Wide
AA 2153 / AAD 2153 5.00mm Wide



Thornton

Double Corneal Ruler
for Astigmatism Surgery
used to Impress a
Symmetrical Pattern of
Ruled Markings on the
Cornea for Placement
of Transverse Incisions
from 0.5mm to 5.0mm
in Length

AA 2155 / AAD 2155 for 6-8mm Optic Zones
AA 2156 / AAD 2156 for 5-7mm Optic Zones



Corneal Marker

For LASIK Surgery
For Identification and Realignment
of the Lamellar Flap

AA 2157 / AAD 2157



Hofmann

T-Incision Marker
With Two 5mm Long Marking Blades

AA 2160 / AAD 2160 5mm Spread
AA 2162 / AAD 2162 6mm Spread
AA 2164 / AAD 2164 7mm Spread
AA 2166 / AAD 2166 8mm Spread



Bores

Parallel Marker
for Surgical Correction of
Astigmatism Blades Spaced
0.75mm Apart 4 Blades

AA 2170 / AAD 2170



Bores

Step Ladder Marker
Used to Mark a 3 Line
Pattern on the Corneal for
Surgical Correction of Astigmatism
1mm Spacing, 1.5mm Wide

AA 2175 / AAD 2175



Maloney

Astigmatism Marker
2 Lines, 3mm Long Spaced
1mm Apart
AA 2180 / AAD 2180



Appa

Lasik Marker
for Proper Flap Re-Alignment
Pointed for Perfect Placement
Over Pupil Opening
AA 2182 / AAD 2182



Maloney

Intra-Operative Keratometer
for Qualitative Measurement
of Astigmatism
AA 2183 / AAT 2183 / AAD 2183
Size 31.0mm Width, 22.0mm Height



Mandel

Intra-Operative Keratometer
3.5mm Dia. Ring used to Project
a Circular Image on the Cornea
for Qualitative Evaluation of
Surgically Induced Astigmatism
AA 2185 / AAD 2185



Hoffer

Optic Zone Marker
With Extra Fine Cross Hairs



AA 2190 / AAD 2190 3.00mm Dia.
AA 2191 / AAD 2191 3.25mm Dia.
AA 2192 / AAD 2192 3.50mm Dia.
AA 2193 / AAD 2193 3.75mm Dia.
AA 2194 / AAD 2194 4.00mm Dia.
AA 2195 / AAD 2195 4.25mm Dia.
AA 2196 / AAD 2196 4.75mm Dia.

AA 2197 / AAD 2197 5.00mm Dia.
AA 2198 / AAD 2198 5.50mm Dia.
AA 2199 / AAD 2199 5.75mm Dia.
AA 2200 / AAD 2200 6.00mm Dia.
AA 2202 / AAD 2202 7.00mm Dia.
AA 2203 / AAD 2203 8.00mm Dia.



Thornton

Optic Zone Marker
With Centering Pin
Very Low Profile

- AA 2210 / AAD 2210 3.00mm Dia.
- AA 2211 / AAD 2211 3.25mm Dia.
- AA 2213 / AAD 2213 3.50mm Dia.
- AA 2214 / AAD 2214 4.00mm Dia.
- AA 2215 / AAD 2215 4.25mm Dia.
- AA 2216 / AAD 2216 4.50mm Dia.
- AA 2217 / AAD 2217 4.75mm Dia.
- AA 2218 / AAD 2218 5.00mm Dia.



Grene

Visual Axis Marker
With 0.5mm Dia.
Concave Tip

- AA 2220 / AAD 2220



Optical Zone Marker

Used to Mark Visual Center For ICSR
Implantation Procedure
Double Ended

- AA 2221 / AAD 2221

Size Total Angled Length 11.0mm, Tip 0.5mm



Mc Donald

Optic Zone Marker for
Photo Refractive
Keratotomy Double-End
With Extra Fine Cross Hairs
6.5 and 7.0mm Dia.

- AA 2225 / AAD 2225



Bores

Optic Zone Marker

- AA 2230 / AAD 2230 2.75mm Dia.
- AA 2231 / AAD 2231 3.00mm Dia.
- AA 2232 / AAD 2232 3.25mm Dia.
- AA 2233 / AAD 2233 3.50mm Dia.
- AA 2234 / AAD 2234 3.75mm Dia.
- AA 2235 / AAD 2235 4.00mm Dia.
- AA 2236 / AAD 2236 4.25mm Dia.
- AA 2237 / AAD 2237 4.50mm Dia.
- AA 2238 / AAD 2238 4.75mm Dia.
- AA 2239 / AAD 2239 5.00mm Dia.
- AA 2241 / AAD 2241 6.00mm Dia.
- AA 2245 / AAD 2245 7.00mm Dia.
- AA 2249 / AAD 2249 8.00mm Dia.



AA - Stainless Steel, AAT - Titanium, AAD - Disposable Instruments

Berkely

Optic Zone Marker Double-End

- AA 2250 / AAD 2250 3.00 & 3.25mm Dia
- AA 2252 / AAD 2252 3.50 & 3.75mm Dia
- AA 2254 / AAD 2254 4.00 & 3.25mm Dia
- AA 2256 / AAD 2256 4.00 & 5.00mm Dia



Osher-Neumann

Radial Marker With Extra Fine Cross Hairs

- AA 2260 / AAD 2260 4 Blades
- AA 2261 / AAD 2261 6 Blades
- AA 2262 / AAD 2262 8 Blades
- AA 2263 / AAD 2263 10 Blades
- AA 2264 / AAD 2264 12 Blades
- AA 2265 / AAD 2265 16 Blades



Anis

Suture Placement Marker for Corneal Grafts, 8 Radial Blades With 8.0mm Centre Opening

- AA 2270 / AAD 2270



Capsulorhexis Marker

Central Ring With Non-Marking Posts for Alignment With Limbus

- AA 2283 / AAD 2283 6mm Diameter Marking Ring
(for 5.5mm CCC)
- AA 2284 / AAD 2284 5.5mm Diameter Marking Ring
(for 5.0mm CCC)



Henderson

Toric Alignment Marker

With Atraumatic Disc-Shaped Marking Surfaces at 3,6 & 9 O' Clock

- AA 2286 / AAT 2286 / AAD 2286



Henderson

Toric IOL Marker

Two 2.5mm Radial Marks Extending to 11mm Titanium (Used With AA-2287)

- AA 2288 / AAT 2288 / AAD 2288



AA - Stainless Steel, AAT - Titanium, AAD - Disposable Instruments

Marking Pen

Gentian Violet

AA 2300 / AAD 2300 Fine Tip

AA 2305 / AAD 2305 Broad Tip



On Request

Micro Beehler Pupil Dilator

Beehler Pupil Dilator Straight

20G, Three Stretching Points

AA 2351 / AAT 2351 / AAD 2351

Straight



Micro Beehler Pupil Dilator

Curved With Smaller Diameter

Darrel for 2.5mm Incision

(Stretching Points).

AA 2352 / AAT 2352 / AAD 2352

Curved



On Request

Beehler Pupil Dilator

Straight four Point Stretching

of Pupil With Three Extendable

"Micro Fingers", Insertion

Through 3mm Incision

AA 2353 / AAT 2353 / AAD 2353

Straight



On Request

Beehler Pupil Dilator

Curved Four Point Stretching

Points of Pupil

AA 2354 / AAT 2354 / AAD 2354

Curved



On Request

Lasek Hokey Knife

Can be Used to Detach

Epithelium from the Incision by

The Sharp Anterior Part of

The Knife and to Reposit the

Epithelium after Ablation by

The Blunt Part of the Knife.

AA 2400 / AAD 2400

Size 5.5mm L, 45° Angled Tip, 1.6mm Width



AA - Stainless Steel, AAT - Titanium, AAD - Disposable Instruments

Lasek
Epithelial Detaching Spatula
AA 2405 / AAT 2405 / AAD 2405



Lasek
Epithelial Micro Hoe
AA 2410 / AAD 2410

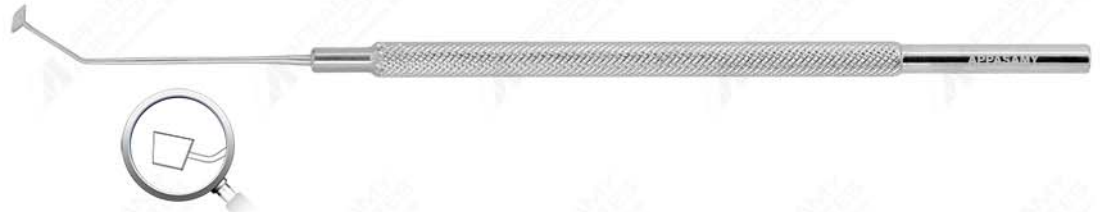

Lasek
Epithelial Flap Repositioning Spatula
AA 2415 / AAT 2415 / AAD 2415



Lasek
Bow Dissector
AA 2420 / AAD 2420



Lasek
Alcohol Well
AA 2425 / AAD 2425 8mm & 8.5mm
AA 2426 / AAD 2426 9mm & 9.5mm



Lasek Trepine
270° Semi-Sharp Edge,
90° Cutout For Flap Hinge
AA 2430 / AAD 2430 8mm & 8.5mm
AA 2431 / AAD 2431 9mm & 9.5mm



AA - Stainless Steel, AAT - Titanium, AAD - Disposable Instruments

ICSR Tunnel Maker

Lift the Cornea to Insert the Tunnel Maker Beneath the Guide
Blunt Tip

AA 2432 / AAD 2432 Left
AA 2433 / AAD 2433 Right



L



R

ICSR Tunnel Maker

Double End Small

AA 2434 / AAT 2434 / AAD 2434

Double End Big

AA 2434A / AAT 2434A / AAD 2434A



Lasek Trephine

270° Semi-Sharp Edge,
90° Cutout for Flap Hinge

AA 2435 / AAD 2435 8mm Trephine & 8.5mm Well

AA 2436 / AAD 2436 8.5mm Trephine & 9mm Well



Dsek

Glider

All Regions of the Outer Corneal Surface can be Gently and Smoothly "Ironed" to Diminish and / or Eliminate Donor Disk Wrinkles

AA 2500 / AAD 2500



Dsek Stromal Scrubber

Easy to Use, and Effectively Roughens the Inner Corneal Stroma Within the Area of Descemetorhexis Circle

AA 2505 / AAD 2505



Dsek

Descemet's Stripper

Desk Desemet's Stripper

Facilitates Easy Removal of DM as a Single Disk

AA 2510 / AAD 2510



Dsek

Reverse Sinskey Hook

AA 2515 / AAT 2515 / AAD 2515

Size 0.2mm Dia, 0.7mm Length



Elevator

for ICSR Implantation

Opens a Small Packet in

Intended Direction

of the Tunnel

Straight

AA 2516 / AAT 2516 / AAD 2516

Size 0.15mm Dia, 0.7mm Length



Suarez Spreader

Widening the Small Packets in Both Directions in a Proper Depth.

Straight

AA 2517 / AAT 2517 / AAD 2517

Size 0.25mm



Bicalto Guide

Lift the cornea to Insert The Tunnel Maker Beneath the Guide.

Blunt Tip, Angled

AA 2518 / AAT 2518 / AAD 2518

Size 5.5mm Length, 0.65mm Dia



Ring Pusher

Suitable for ICSR Surgery

AA 2519 / AAT 2519 / AAD 2519

Size 3.0mm length, 0.4mm Dia



Dsek

Marker

For Marking on Recipient Cornea

AA 2520 / AAD 2520

Size 3.5mm Height, 12mm Dia



Dsek

Corneal Dissector

Double-Ended

AA 2525 / AAT 2525 / AAD 2525

Size 0.8mm Width, 14mm Length & 1.6mm Width, 11mm Length



AA - Stainless Steel, AAT - Titanium, AAD - Disposable Instruments

Dsek

Donor Lamella Shovel

It Helps to Prevent the Folded Donor Lamella From Sliding of During Insertion

AA 2530 / AAT 2530 / AAD 2530



DMEK Rake

Blunt T-Shaped Rake to Help Easily Pull the Descemet's Membrane Away from the Stroma.

AA 2535 / AAT 2535 / AAD 2535



DMEK Large Crystal Spatula

Spatula has a Smooth, Rounded, Olive Tip Extremity Which is Specially Designed to use on the Donor Descemet's Membrane Within the Recepter Anterior Chamber.

AA 2540 / AAT 2540 / AAD 2540



DMEK Small Crystal Spatula

Overall Length: 115mm
Angle to Tip Length: 10mm
Tip Diameter: 0.3mm

AA 2545 / AAT 2545 / AAD 2545



Dexatome DMEK/DSAEK Spatula Single

Single Instrument Allows for Both Descemetorhexis and Descemet's Membrane Detachment and Subsequent Removal. Unique Multi-Curve Design Facilitates Complete Scoring of Descemet's Membrane 360° Without Exiting the Anterior Chamber.

AA 2550 / AAT 2550 / AAD 2550



Dalk

Corneal Dissector

12mm Long Flattened Vaulted Spatula With Beveled Tip

AA 2555 / AAT 2555 / AAD 2555



Rosenwasser DALK

Trisector

With Triangular Shaft and
Spatulated Tip

AA 2560 / AAT 2560 / AAD 2560
Size 0.2mm



Bonfadini DALK Spatula

1mm Wide, 8mm Long,
Flattened Spatula With
Central Groove for
Bisecting Stroma

AA 2565 / AAT 2565 / AAD 2565



Behler

Lasik Enhancement Hook

AA 2600 / AAT 2600 / AAD 2600



Seibel

Lasik Flap Lifter
& Spatula
Double-Ended

AA 2605 / AAT 2605 / AAD 2605



Hardten

Lasik Flap Lifter
& Spatula
Double-Ended

AA 2610 / AAT 2610 / AAD 2610



Lasik Flap

Protector
& Spatula

AA 2615 / AAT 2615 / AAD 2615



Lasik Flap Protector Blades

Angled 45° for Retracting and
Protecting Superiorly Hinged
Corneal Flaps.

AA 2620 / AAT 2620 / AAD 2620



AA - Stainless Steel, AAT - Titanium, AAD - Disposable Instruments

Lasik Flap Protector Blades
Angled 15° for Retracting and
Protecting Superiorly Hinged Corneal Flaps.
AA 2625 / AAT 2625 / AAD 2625



Lasik Spatula
Dual 12mm Long 0.25mm
Diameter Arms
AA 2630 / AAT 2630 / AAD 2630



Zirm
Lasik Cornea Surface Cleaner
AA 2635 / AAT 2635 / AAD 2635



Lasik Flap Edge
Dissector for Lasik Enhancements
AA 2640 / AAT 2640 / AAD 2640



Lasik Flap Manipulator
Delicate Olive Tip
AA 2645 / AAT 2645 / AAD 2645



Thorlakson
LASIK Flap Lifter
Combines a Modified Sinskey
Hook and a Bi-Convex Spatula
With Beveled Notches
AA 2650 / AAT 2650 / AAD 2650
Short Handle



Membrane Spatula
1.5mm Angled, 20 G
AA 2700 / AAT 2700 / AAD 2700



Membrane Spatula Knife

5.0mm Angled,
All Edges Sharp, 20 G
AA 2735 / AAT 2735 / AAD 2735



Membrane Spatula

With Pointed Tip,
5.0mm Angled, 20 G
AA 2740 / AAT 2740 / AAD 2740



Membrane Spatula

Subretinal Pic, Flat,
4.0mm Angled
0.3X0.15mm
AA 2745 / AAT 2745 / AAD 2745



Delicate Membrane Pick

AA 2746 / AAT 2746 / AAD 2746 25G
AA 2747 / AAT 2747 / AAD 2747 27G



Membrane Spatula

Subretinal Pic, Flat,
4.0mm Angled
0.3X0.2mm
AA 2750 / AAT 2750 / AAD 2750



Membrane Spatula

2.0 and 4.0mm Angled, 20 G
AA 2755 / AAT 2755 / AAD 2755



Membrane Spatula
2.0mm Angled, 20 G
AA 2705 / AAT 2705 / AAD 2705



Membrane Spatula
2.5mm Angled, 20 G
AA 2710 / AAT 2710 / AAD 2710



Membrane Spatula
5.0mm Angled, 20 G
AA 2715 / AAT 2715 / AAD 2715



Ogura PVD Spatula
AA 2716 / AAT 2716 / AAD 2716 23 G



Membrane Spatula
0.5mm Curved, Short Rakes,
Round Edges, 20 G
AA 2720 / AAT 2720 / AAD 2720



Membrane Spatula
1.0mm Angled, Short Rakes, 20 G
AA 2725 / AAT 2725 / AAD 2725



Membrane Spatula
1.0mm Angled, Long Rakes, 20 G
AA 2730 / AAT 2730 / AAD 2730



AA - Stainless Steel, AAT - Titanium, AAD - Disposable Instruments

Membrane Spatula
Rough, Angled, 20 G
AA 2760 / AAT 2760 / AAD 2760



Lucke Membrane Spatula
Round, Curve, 20 G
AA 2765 / AAT 2765 / AAD 2765



Membrane Peeler
1.0mm Angled,
24 G / 0.6mm
AA 2770 / AAT 2770 / AAD 2770



Membrane Peeler
1.0mm Angled,
20 G / 0.9mm
AA 2775 / AAT 2775 / AAD 2775



Membrane Peeler
Blunt, With Peeling Edges, 20 G
AA 2780 / AAT 2780 / AAD 2780



Membrane Peeler
Rough, Angled, 20G / 0.9mm for MIS
AA 2785 / AAT 2785 / AAD 2785



Morris-Kroll Membrane Peeler

Membrane Peeler

1.5mm Angled,
20 G / 0.9mm

AA 2790 / AAT 2790 / AAD 2790



BRVO Knife

Is Designed for Performing a
Lateral CRVO Incision

AA 2791 / AAT 2791 / AAD 2791 20 G

AA 2792 / AAT 2792 / AAD 2792 23 G



LRI Slit Lamp Gravity Marker

Pre-Op Reference Marker

Designed for Limbal Relaxing Incisions
and Toric IOL Implantation

To Mark Precision Horizontal Axis at
the Slit Lamp at 3 and 9 O' Clock

AA 2800 / AAT 2800 / AAD 2800



Whitehouse Gravity Axis Marker II

Pre-Op Reference Marker

Modified Whitehouse Gravity
Marker With Reduced Diameters
Straight

AA 2805 / AAT 2805 / AAD 2805



Appa Lane

Pre-Op Toric Reference marker

Pre-Op Toric Reference Marker

Single Side Open View. Marking Plates are
Curved to Conform to the Curvature of the
Eye for More Even and Clear Marks. Marks
at 3, 6, and 9 O' Clock.

AA 2810 / AAT 2810 / AAD 2810



Toric IOL Combo Marker

Pre-Op Marker to Mark the Axis

While the Patient is in Sitting Position
at the Slit Lamp

Reduces Cyclotorsion Effect in Supine
Position.

AA 2815 / AAT 2815 / AAD 2815



AA - Stainless Steel, AAT - Titanium, AAD - Disposable Instruments

LRI Marker

Intra-Op LRI/Toric Marker
Automatically Creates Marks for
6 & 8mm Chord Length of Limbal
Relaxing Incision.
Round Serrated Handle
AA 2820 / AAT 2820 / AAD 2820



LRI Marker

Intra-Op LRI/Toric Marker
Automatically Creates Marks at
40-60-80 Degrees of Limbal
Relaxing Incision.
Round Serrated Handle
AA 2825 / AAT 2825 / AAD 2825



Appa - Lane

Pro-Op Toric Reference Marker With Bubble level

Intra-Op LRI/Toric Marker
Automatically Creates Marks at
40-60-80 Degrees of Limbal
Relaxing Incision.
Round Serrated Handle
AAT 2830 / AAD 2830
For Both Eyes

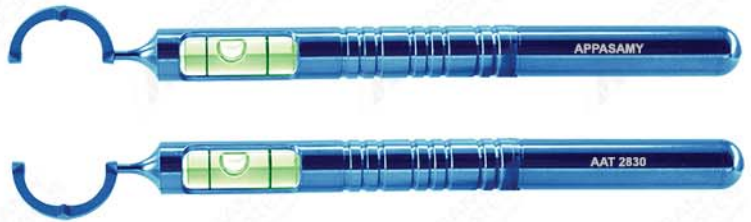

Bores Toric IOL Pre-Op Marker

With Bubble Level Indicator to be used in
Tandem with Mandez Degree Gauge
Used With AA 2140
AAD 2835



LRI Axis Marker

Pre-Op Reference Marker
Designed for Limbal Relaxing
Incision To Mark Precision
Horizontal Axis at the Slit Lamp.
AA 2840 / AAT 2840 / AAD 2840



Appa-Lane

Pre Op Toric Reference Marker

Marking Pattern in Located On Both Sides for Making The Left & Right Eye Temporarily Marking Plates are Curved to Conform to The Curvature of the Eye for More Even and Clear Marks

Marks at 3 and 9 O' Clock

AA 2860 / AAT 2860 / AAD 2860



Yeoh Thin Toric Gauge

Marking are Show at Every 5° With 4 Slots at 0°, 90°, 180° and 270°. Slots at 0° and 180° are at the Inner Ring and Slots are 90° and 270° for the Outer Ring. The Surgeon can Insert a Marking Pen Tip in the Slot for Marking.

AA 2865 / AAT 2865 / AAD 2865



Graether Degree Gauge

Four Elevated Extension on Bottom at 0°, 90°, 180°, 270° Which can be Used as Stabilizers or for Putting Clean Intra-Op Marking on the Eye. Can Also Potentially be used as a Pre-Op Marker. Degree Marking are 10° Apart

AA 2870 / AAT 2870 / AAD 2870



Appa Two Blades Axis Marker

Single Side Open View. Marking Plates are Curved to Conform to the Curvature of the Eye for more even and Clear Marks.

Marks at 3, 6, and 9 O' Clock

AA 2875 / AAT 2875 / AAD 2875



Agarwal Glued IOL Marker

Marks Exactly 180° Apart, for Making the Square Scleral Flaps.

AA 2890 / AAT 2890 / AAD 2890

Size 3.0mm Wide



- ★ Colibri Forceps
- ★ Hoskin Forceps
- ★ Corneal Forceps
- ★ Suturing Forceps
- ★ Fixation & superior Rectus Forceps
- ★ Conjunctiva Forceps
- ★ Muscle Forceps
- ★ Chalazion Forceps
- ★ Foldable IOL Forceps & Lens Cutter
- ★ Tying Forceps
- ★ Capsulorhexis Forceps
- ★ Jewelers Forceps
- ★ Pre Chopper
- ★ Artery Forceps
- ★ Vitreo Retinal Forceps

VARIOUS TYPES OF FORCEPS TIPS

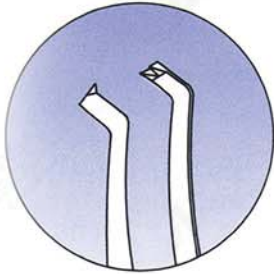

1x2 Colibri Style

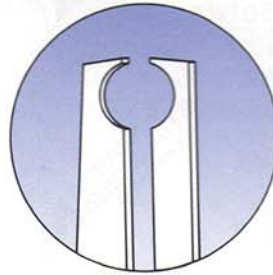

Pierse Hoskin Tip

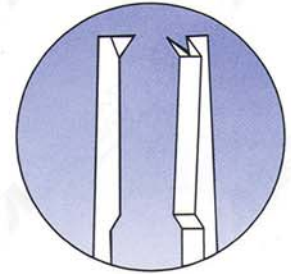

1x2 Corneal Forceps

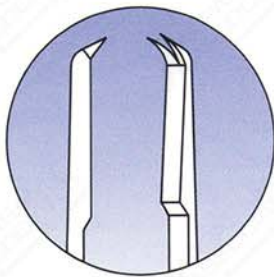

1x2 Suturing Forceps
(Castroviejo Style)

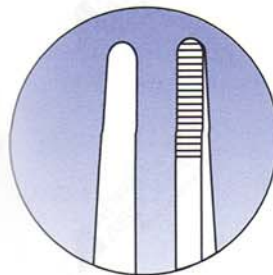

Horizontal

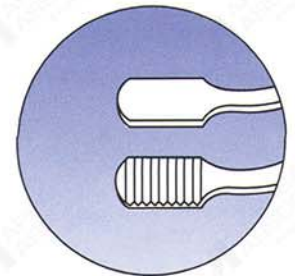

Lens Holding Forceps

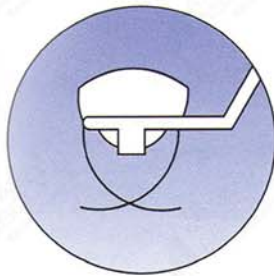

Lens Folder

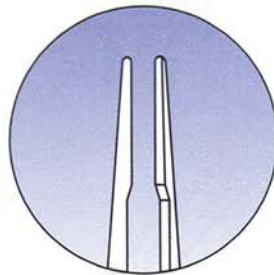

Suture Tying Forceps
With Platform

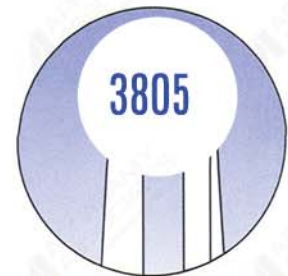

Mc-Pherson Angled

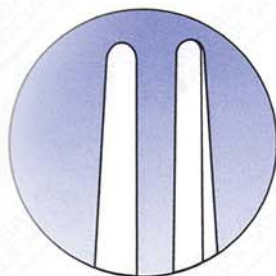

Jewelers Type
(Plain Type Tip)

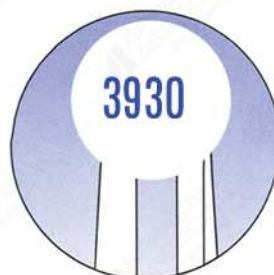

Artery Forceps

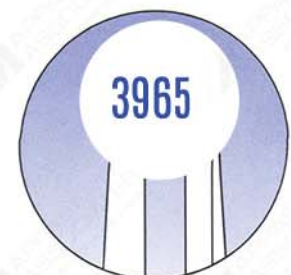

Vitreo Retinal

Botvin
Iris Forceps
AA 3005 / AAT 3005 / AAD 3005
Serrated Tip
AA 3007 / AAT 3007 / AAD 3007
1x2 Teeth



Gill
Iris Forceps Curved
AA 3010 / AAT 3010 / AAD 3010
Criss-Cross Serrated Tips
AA 3012 / AAT 3012 / AAD 3012
1x2 Teeth



Swiss Model
Iris Forceps
Curved, Very Delicate
AA 3015 / AAT 3015 / AAD 3015
1 x 2 teeth



Iris Forceps
Very Delicate 0.5mm Teeth
AA 3016 / AAT 3016 / AAD 3016

On Request



Hess
Iris Forceps
Swiss Model
AA 3020 / AAT 3020 / AAD 3020
1x2 Teeth



Hess
Iris Forceps
Standard Model
AA 3025 / AAT 3025 / AAD 3025
1x2 Teeth



Barraquer Colibri

Forceps, Very Delicate

1 x 2 Teeth, 0.12mm

AA 3030 / AAT 3030 / AAD 3030

With Tying Platform

AA 3031 / AAT 3031 / AAD 3031

Without Tying Platform



Colibri

Forceps

0.4mm, 1 x 2 Teeth

With Tying Platform,

AA 3035 / AAT 3035 / AAD 3035



Gill-Colibri

Forceps

Very Fine, Pointed Tips

AA 3040 / AAT 3040 / AAD 3040



Harms Colibri

Suturing Forceps

Very Delicate

1 x 2 Teeth, 0.12mm

With Tying Platform

AA 3045 / AAT 3045 / AAD 3045



Birk

Colibri Forceps

0.12mm, 1 x 2 Teeth

With 5mm Tying Platform and

2.0mm Angled Tips

Round Knurled Short Handle

AA 3050 / AAT 3050 / AAD 3050



On Request

Polack

Double Corneal Forceps

For Corneal Suturing

Very Delicate, 1 x 2 Teeth,

0.12mm

AA 3055 / AAD 3055 Flat Handle

AA 3056 / AAD 3056 Round Handle



On Request

Nordan

Colibri Forceps
0.12mm 1x2 Teeth With 5mm
Tying Platforms and
2.0mm Angled Tips
Round Handle
AA 3057 / AAT 3057 / AAD 3057



Pierse

Corneal Forceps
0.1mm Diameter
Straight
AA 3060 / AAT 3060 / AAD 3060



Pierse Type

Micro Forceps
Straight, Long Handle
AA 3065 / AAT 3065 / AAD 3065
#13 1.5mm Tip
AA 3070 / AAT 3070 / AAD 3070
#14 1.5mm Tip
AA 3075 / AAT 3075 / AAD 3075
#15 0.2mm Tip



Pierse Type

Micro Forceps Curved
AA 3080 / AAT 3080 / AAD 3080
16 0.3mm Tip
AA 3085 / AAT 3085 / AAD 3085
24 0.5mm Tip



Pierse Type

Micro Forceps
Straight Skeleton Fine
AA 3090 / AAT 3090 / AAD 3090
#18 0.5mm Tip
AA 3095 / AAT 3095 / AAD 3095
#19 0.2mm Tip
AA 3100 / AAT 3100 / AAD 3100
#20 0.8mm Tip



Pierse Type

Fine Colibri Beaked Forceps

AA 3105 / AAT 3105 / AAD 3105

#21 0.5mm Tip

AA 3110 / AAT 3110 / AAD 3105

#22 0.2mm Tip

AA 3115 / AAT 3115 / AAD 3115

#23 0.8mm Tip

AA 3120 / AAT 3120 / AAD 3120

#30 0.2mm Tip

With Tying Platform



Castroviejo

Colibri Forceps

Very Delicate,

1 x 2 Teeth, 0.12mm

AA 3125 / AAT 3125 / AAD 3125



Castroviejo

Colibri Forceps

Very Delicate, 1 x 2 Teeth

0.12mm With Tying Platform

AA 3130 / AAT 3130 / AAD 3130



Tennant - Maumenee

Colibri Forceps

With Tying Platform,

1 x 2 Teeth, 0.12mm

AA 3135 / AAT 3135 / AAD 3135

AA 3137 / AAT 3137 / AAD 3137

With Suture Cutter



On Request

Anis

Corneal Forceps

With Tying Platform,

1 x 2 Teeth, 0.12mm

AA 3140 / AAT 3140 / AAD 3140

AA 3142 / AAT 3142 / AAD 3142

With Suture Cutter



On Request

Lim's

Pierse Type Forceps

AA 3144 / AAT 3144 / AAD 3144

18 0.5mm Tip



Lim's

Corneoscleral Forceps
With Tying Platform
1 x 2 Teeth 0.12mm

AA 3145 / AAT 3145 / AAD 3145



On Request

Lim's

Suturing Forceps
With Tying Platform
1 x 2 Teeth, 0.12mm

AA 3146 / AAT 3146 / AAD 3146



Mc Pherson

Corneal Forceps 1 x 2 Teeth
0.4mm With Tying Platform

AA 3150 / AAT 3150 / AAD 3150 Straight
AA 3155 / AAT 3155 / AAD 3155 Angled



Kelman - Mc Pherson

Corneal Forceps
7.5mm Long Angled Jaws,
1 x 2 Teeth, 0.3mm

AA 3160 / AAT 3160 / AAD 3160



Hoffer - Mc Pherson

Corneal Forceps
Very Delicate
11mm Long Angled Jaws
1 x 2 Teeth, 0.12mm

AA 3165 / AAT 3165 / AAD 3165



Bonn

Corneal Forceps
With Tying Platform
1 x 2 Teeth, 0.12mm

AA 3170 / AAT 3170 / AAD 3170 Long Model
AA 3175 / AAT 3175 / AAD 3175 Short Model
AA 3176 / AAT 3176 / AAD 3176 Short Model Curved



Castroviejo

Suturing Forceps

1 x 2 Teeth, With Tying Platform

AA 3180 / AAT 3180 / AAD 3180 0.12mm

AA 3185 / AAT 3185 / AAD 3185 0.30mm

AA 3190 / AAT 3190 / AAD 3190 0.50mm

AA 3191 / AAD 3191 0.50mm With Lock

AA 3195 / AAT 3195 / AAD 3195 0.90mm

AA 3200 / AAD 3200 1.50mm



Castroviejo

Suturing Forceps

1 x 2 Teeth, Without Tying Platform

AA 3204 / AAT 3204 / AAD 3204

0.3mm, 5mm Angled



Castroviejo

Suturing Forceps

1 x 2 Teeth, With Tying Platform

AA 3205 / AAT 3205 / AAD 3205

0.3mm, 5mm Angled



Castroviejo

Suturing Forceps

1 x 2 Teeth, With Tying Platform

AA 3220 / AAT 3220 / AAD 3220

0.5mm, 7.5mm Angled



Bishop-Harmon

Tissue Forceps

1 x 2 Teeth

AA 3250 / AAT 3250 / AAD 3250

Extra Delicate 0.4mm

AA 3255 / AAT 3255 / AAD 3255

Delicate 0.8mm



Bishop-Harmon

Dressing Forceps

Criss - Cross Serrated Tips

AA 3260 / AAT 3260 / AAD 3260



Iris

Forceps

1 x 2 teeth 0.4mm Teeth

AA 3265 / AAT 3265 / AAD 3265 Curved



AA - Stainless Steel, AAT - Titanium, AAD - Disposable Instruments

Kirby
Iris Forceps
1 x 2 Teeth
AA 3270 / AAT 3270 / AAD 3270 Curved



St. Martin
Suturing Forceps
AA 3275 / AAT 3275 / AAD 3275
1 x 2 Teeth
Size 0.45mm



Snider-Castroviejo
Suturing Forceps
With Guide Pin 1 x 2 Teeth
0.12mm With Tying Platform
AA 3280 / AAT 3280 / AAD 3280



Fixation
Forceps
AA 3300 / AAT 3300 / AAD 3300
1 x 2 Teeth



Adson
Fixation Forceps
AA 3301 / AAT 3301 / AAD 3301
1 x 2 Teeth, Standard



Elsching
Fixation Forceps
1 x 2 Teeth Stright
AA 3304 / AAT 3304 / AAD 3304
1 x 2 Teeth Angled
AA 3305 / AAT 3305 / AAD 3305



Fixation
Forceps
AA 3310 / AAD 3310
2 x 3 Teeth, Angular
AA 3312 / AAD 3312
2 x 3 Teeth, Straight



Graefe
Fixation Forceps
4.5mm Wide Jaws
AA 3315 / AAD 3315 With Catch
AA 3317 / AAD 3317 Without Catch



AA - Stainless Steel, AAT - Titanium, AAD - Disposable Instruments

On Request

Green

Fixation Forceps
Multiple teeth

AA 3320 / AAD 3320 5mm Wide Jaws
AA 3325 / AAD 3325 10mm Wide Jaws



Lester

Fixation Forceps
Straight

AA 3330 / AAD 3330 1 x 2 Teeth
AA 3335 / AAD 3335 2 x 3 Teeth



Dastoor

Superior Rectus Forceps

AA 3340 / AAT 3340 / AAD 3340
1 x 2 Teeth



Moody

Fixation Forceps

1 x 2 Teeth, 0.5mm
AA 3350 / AAT 3350 / AAD 3350 Left
AA 3351 / AAT 3351 / AAD 3351 Right



On Request

Bores

Fixation Forceps

3mm Spread, Each 0.12mm,
1 x 2 Teeth

AA 3400 / AAD 3400 Straight
AA 3405 / AAD 3405 Curved

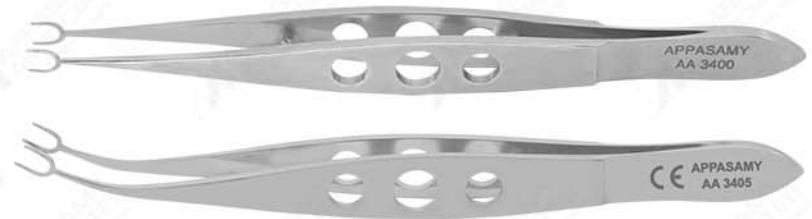

On Request

Kramer

Corneal Fixation Forceps

With Lock "U" Shaped 13mm Spread,
Each 0.12mm, 1 x 2 Teeth

AA 3410 / AAD 3410
Straight With Catch



Nevyes-Wallace Fixation Forceps

For ICSR Surgery
Two Point Fixation
Tips Separated By 13.0mm
Straight

AA 3411 / AAD 3411



On Request

CE APPASAMY AA 3411

Kramer

Corneal Fixation Forceps
With Lock "U" Shaped 13mm Spread,
Each 0.12mm, 1 x 2 Teeth

AA 3415 / AAD 3415

Curved With Catch



On Request

CE APPASAMY AA 3415

Eye Dressing

Forceps
Serrated Delicate

AA 3450 / AAT 3450 / AAD 3450

Straight

AA 3455 / AAT 3455 / AAD 3455

Curved



CE APPASAMY AA 3450

Adson

Dressing Forceps

AA 3451 / AAT 3451 / AAD 3451



APPASAMY AA 3451

Wills Hospital

Utility Forceps

Criss - Cross Serrated Tips

AA 3460 / AAT 3460 / AAD 3460



CE APPASAMY AA 3460

Bonaccolto

Utility Forceps

Longitudinally Serrated Jaws

With Cross Serrations at Tips

AA 3465 / AAT 3465 / AAD 3465

1.2mm Wide

AA 3467 / AAT 3467 / AAD 3467

1.7mm Wide



CE APPASAMY AA 3465



CE APPASAMY AA 3467

Moorfield

Conjunctival Suture Forceps
Horizontally Serrated Jaws
With Groove

AA 3470 / AAT 3470 / AAD 3470



Jayle

Corneal Suture &
Fixation Forceps
1 x 2 Teeth, With Tying Platform

AA 3475 / AAT 3475 / AAD 3475



Barraquer

Cilia Forceps
Lightly Angled, Smooth Jaws

AA 3480 / AAT 3480 / AAD 3480



Beer

Cilia Forceps

AA 3485 / AAT 3485 / AAD 3485



On Request

Gradle

Cilia Forceps
Smooth, Squared Off
Positive Gripping Jaws

AA 3490 / AAD 3490



Elschnig

Capsule Forceps

AA 3500 / AAD 3500



Arruga

Capsule Forceps

AA 3505 / AAD 3505



Arruga
Capsule Forceps
AA 3510 / AAD 3510
New Curve



Hess
Extra Capsular Forceps
AA 3515 / AAD 3515 Simple Curve
AA 3517 / AAD 3517 Double Curve



On Request

Prince
Advancement Forceps
AA 3525 / AAD 3525 Left
AA 3530 / AAD 3530 Right



On Request

Jameson
Muscle Forceps
with slide lock
AA 3533 / AAD 3533 Left, Child 3 Teeth
AA 3534 / AAD 3534 Right, Child 3 Teeth
AA 3535 / AAD 3535 Left, Child 4 Teeth
AA 3540 / AAD 3540 Right, Child 4 Teeth
AA 3545 / AAD 3545 Left, Child 6 Teeth
AA 3550 / AAD 3550 Right, Child 6 Teeth



Worth
Advancement Forceps
With Slide Lock
Longitudinally Grooved Jaws
AA 3555 / AAD 3555 Left
AA 3560 / AAD 3560 Right



Berke

Ptosis Forceps
With Slide Lock
Longitudinally Grooved Jaws
AA 3565 / AAD 3565 20mm
AA 3570 / AAD 3570 27mm



Snellen

Entropion Forceps
AA 3600 / AAD 3600 Left, Small
AA 3605 / AAD 3605 Right, Small
AA 3607 / AAD 3607 Left, Adult
AA 3609 / AAD 3609 Right, Adult



Erhardt

Lid Forceps
AA 3610 / AAD 3610



Trachoma Forceps

AA 3611 / AAD 3611 Small, 26mm Width
AA 3612 / AAD 3612 Medium, 28mm Width
AA 3613 / AAD 3613 Large, 30mm Width
AA 3614 / AAD 3614 Extra large, 32mm Width



Ayer

Chalazion Forceps
AA 3615 / AAT 3615 / AAD 3615
Size 9mm Inner Plate & 12mm Outer Dia



Lambert

Chalazion Forceps
Round, 8mm Diameter
AA 3620 / AAT 3620 / AAD 3620



Desmarres

Chalazion Forceps
Oval Shape

- AA 3625 / AAT 3625 / AAD 3625 13mm Dia.
- AA 3626 / AAT 3626 / AAD 3626 20mm Dia.
- AA 3627 / AAT 3627 / AAD 3627 26mm Dia.
- AA 3628 / AAT 3628 / AAD 3628 31mm Dia.

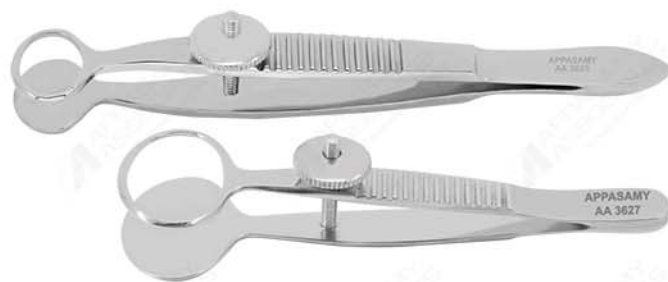

Hunt

Chalazion Forceps
Round, 12mm Diameter

- AA 3630 / AAT 3630 / AAD 3630



Anis

Lens Holding Forceps
Extra Delicate
9mm long Smooth Jaws
45° Angle

- AA 3650 / AAT 3650 / AAD 3650



Blaydes

Lens Holding Forceps
Very Delicate Narrow
Smooth Jaws, 45° Angle

- AA 3655 / AAT 3655 / AAD 3655



Clayman

Lens Holding Forceps
Delicate With Curved Shanks

- AA 3660 / AAT 3660 / AAD 3660



Dodick

Lens Holding Forceps
Angled Smooth Jaws,
Angled Forward for Comfortable
Hand Position

- AA 3665 / AAT 3665 / AAD 3665 Angled Left
- AA 3667 / AAT 3667 / AAD 3667 Angled Right



AA - Stainless Steel, AAT - Titanium, AAD - Disposable Instruments

Kellan

Endocapsular IOL Insertion Forceps
Diameter of the Tip
is 0.15mm for Implantation of
the Superior Haptic of IOL
AA 3670 / AAT 3670 / AAD 3670



Forceps for ICSR Implant

Used for ICSR Implantation
1x1 Teeth 0.2mm
0.3mm Groove
AA 3671 / AAT 3671 / AAD 3671



Kraff

On Request
Lens Holding Forceps
Delicate, Curved Jaws to Grasp
PC Lens Optic Edge
AA 3675 / AAT 3675 / AAD 3675
Flat Handle
AA 3677 / AAT 3677 / AAD 3677
Round Handle



Kratz

Lens Holding Forceps
With Smooth Curved Jaws
AA 3680 / AAT 3680 / AAD 3680



Shepard

On Request
Lens Holding Forceps
Serrated Jaws
AA 3685 / AAD 3685 With Lock



Shepard

Lens Holding Forceps
3mm Lower Jaw and 1.5mm
Upper Jaw
AA 3690 / AAT 3690 / AAD 3690



Lieberman

On Request
Lens Forceps
T-Bar on Upper and
Lower Jaws for
Excellent Stability in Holding
Biconvex IOL
AA 3695 / AAD 3695 With Lock
AA 3697 / AAD 3697 Without Lock



On Request

Sinsky

For IRIS CLAW
Lens Holding Forceps
With Delicate T-Shaped Lower Jaw
Ideal for Biconvex
Ridged or Plano Lenses
AA 3700 / AAD 3700 45° Angle
AA 3702 / AAD 3702 with Lock
AA 3704 / AAD 3704 15° Angle



Simcoe II

One Short Blunt
and Long Sharp Tip
AA 3705 / AAT 3705 / AAD 3705



On Request

Lieberman

Micro-Ring Lens Forceps
1.2mm Dia. Ring Ideal for
Implanting IOLs
AA 3710 / AAD 3710



Trocar Loading Forceps

AA 3712 / AAT 3712 / AAD 3712



Faulkner

With Smooth Polished Round Jaws
Pick Up Foldable IOL
From Case Without Marking
or Damage the Lens
AA 3715 / AAT 3715 / AAD 3715



On Request

Utrata

Foldable Lens Retriever
Angled With Teeth
AA 3716 / AAT 3716 / AAD 3716



On Request

Utrata

Foldable Lens Cutter
Snare Loop
AA 3717 / AAD 3717 / AAT 3717



AA - Stainless Steel, AAT - Titanium, AAD - Disposable Instruments

Chu
Foldable Lens Cutter
For Soft Intraocular Lenses
AA 3718 / AAD 3718



Chu
Foldable Lens Cutter
Groove Tip 11mm
AA 3718A / AAD 3718A



Foldable Lens Cutter
To Cut Silicone or Acrylic IOL
In Case of Complications
AA 3719 / AAD 3719



Appasamy Lens Cutter
To Cut Silicone IOL
In Case of Complications.
By Sideport Incision
AA 3719A / AAD 3719A



On Request

Foldable Lens Removing Forceps
To Remove Silicone or Acrylic IOL
In Case of Complications
AA 3720 / AAD 3720



On Request

Dsek
Inserting Forceps
Kelman Forceps With Tissue
Clearance Release the
Disk Less Easily and Require
Hand Rotation for Insertion of
Taco Folded Doner Disk
AA 3721 / AAD 3721



Foldable Lens
Cutting Forceps
Round Handle, Serrated Blade Tip
AA 3722 / AAD 3722



On Request

Faulkner

Lens Inserting Forceps
for Folding and Inserting
Soft IOLs Through Small Incision
AA 3725 / AAD 3725



On Request

Faulkner II

Lens Inserting Forceps
for Foldable IOL
AA 3730 / AAD 3730



Rosenwasser

Donor Lamella Inserting Forceps
Thin Vaulted 12mm Long Shanks
Precalibrated Heel Stops to Prevent
Tips From Closing
AA 3731 / AAT 3731 / AAD 3731



On Request

Appasamy

Universal Lens Injector
AA 3737 / AAT 3737 / AAD 3737



CTR Injector

Pre-loaded Capsular Tension Ring
AAT 3738 / AAD 3738



On Request

Lens Folder And Pusher

AAT 3739 / AAD 3739



On Request

Kellan

Foldable IOL Forceps
Designed to Contour the
Silicone IOL Rather
Than Fold the IOL
AA 3740 / AAD 3740



AA - Stainless Steel, AAT - Titanium, AAD - Disposable Instruments

Appasamy

Lens Folding Forceps
Cross Action
Ideal for Silicone & Acrylic
Foldable Lenses. Consistently
Folds the IOL Evenly and Equally
While Preventing the Lens From
Reverse Folding
AA 3741 / AAT 3741 / AAD 3741

On Request



Appasamy

Lens Folding Forceps
Direct Action
For Foldable Lens
Evenly Folds Acrylic and
Silicone Lenses of
5.5mm or 6mm Diameter
AA 3742 / AAT 3742 / AAD 3742

On Request



Appasamy

Lens Inserting Forceps
For Foldable Lens
30° Angled Tip
With 45mm Tip Opening
AA 3743 / AAT 3743 / AAD 3743

On Request



Appasamy

Lens Inserting Forceps
for Foldable Lens
Flat Body (Cross Action)
AA 3744 / AAT 3744 / AAD 3744

On Request



Appasamy

Universal Lens Folding
Forceps (Round Stock)
AA 3745 / AAT 3745 / AAD 3745

On Request



Appasamy

Lens Implantation Forceps
(Direct Action)
AA 3746 / AAT 3746 / AAD 3746

On Request



Appasamy

Universal Lens Folding Forceps
Flat Stock, Ideal for Silicone and
Acrylic Foldable IOLs, Box Model
Jaws Facilitates, the Folding of the
Lens Precisely for Transfer
to the Inserter

AA 3747 / AAT 3747 / AAD 3747



On Request

Appasamy

Universal Lens inserting Forceps
Ideal for Silicone and Acrylic
Foldable IOLs, for Box Model,
Smooth Curved Jaws With
Rounded Edges, Grip the Lens
Gently and Firmly

AA 3748 / AAT 3748 / AAD 3748



On Request

Donnenfeld

Micro Soft IOL Cutter
4mm Long Blades
Micro Notches in Blades for Traction

AA 3749 / AAT 3749 / AAD 3749



On Request

Donnenfeld

Micro IOL Holding Forceps 21 G
Blunt, Paddle-Shaped Tips
Central Hole for Traction and Visibility
For Grasping a Soft IOL During Cutting and Explantation.

AA 3749A / AAT 3749A / AAD 3749A



On Request

Jaffe

Tying Forceps
Smooth Jaws With 5mm
Long Platform, Ideal for
8-0 to 11-0 Sutures

AA 3750 / AAT 3750 / AAD 3750 Straight

AA 3755 / AAT 3755 / AAD 3755 Curved



Tennant

Tying Forceps

With Guide Pin, Extra Delicate
Smooth Jaws, with 5mm Long
Platform for 9-0 to 11-0 Sutures

AA 3760 / AAT 3760 / AAD 3760 Straight
AA 3765 / AAT 3765 / AAD 3765 Curved

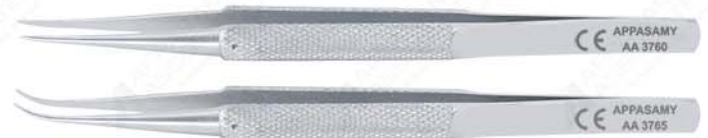

Harms

Tying Forceps

Smooth Jaws, with 0.5mm Tip Width
5mm Long Platform
Ideal for 7-0 to 9-0 Sutures

AA 3770 / AAT 3770 / AAD 3770 Straight
AA 3775 / AAT 3775 / AAD 3775 Curved



Jayle

Tying Forceps

Smooth Jaws, With, 0.8mm Tip Width
5mm Long Platform
Ideal for 7-0 to 9-0 Sutures

AA 3780 / AAT 3780 / AAD 3780 Straight
AA 3781 / AAT 3781 / AAD 3781 Curved



Mc Pherson

Tying Forceps Small Handle

Smooth Jaws, 5mm Long Platform
Ideal for 8-0 to 11-0 Sutures

AA 3785 / AAT 3785 / AAD 3785
Straight

AA 3786 / AAT 3786 / AAD 3786
Curved



Mc Pherson

Tying Forceps

Smooth Jaws, 5mm Long Platform
Ideal for 8-0 to 11-0 Sutures

AA 3790 / AAT 3790 / AAD 3790
Straight Long Handle



Mc Pherson

Tying Forceps

Smooth Jaws

5mm Long Platform, 5mm Angled

Idea for Implanting IOL &

8-0 to 11-0 Sutures

AA 3793 / AAT 3793 / AAD 3793 Short Handle

AA 3795 / AAT 3795 / AAD 3795 Long Handle



Kelman-Mc Pherson

IOL Forceps

Smooth Jaws, 5mm Platform,

7.5mm Angled,

Ideal for Implanting IOL

AA 3798 / AAT 3798 / AAD 3798 Short Handle

AA 3800 / AAT 3800 / AAD 3800 Long Handle



Mc Pherson

IOL Forceps

Smooth Jaws, 11mm Long

Platform Angled,

Ideal for Implanting IOLs

AA 3805 / AAT 3805 / AAD 3805



Sinskey

Tying Forceps

Very Delicate Smooth Jaws

Ideal for 8-0 to 11-0 Sutures

AA 3810 / AAD 3810 Straight

AA 3815 / AAD 3815 Curved



Kraff

Capsule Tag Forceps
11mm Long Jaws With
1.5mm Long Smooth
Platform at Tips.
Recessed Inside Jaws Surfaces
Prevent Inadvertent IRIS Pickup
AA 3850 / AAT 3850 / AAD 3850



Utrata

Capsulorhexis Forceps
Very Delicate Grasping Tips and
Extremely Thin 11mm
Long Straight Shanks
AA 3855 / AAT 3855 / AAD 3855
AA 3855A / AAD 3855A Marking 2.0
AA 3855B / AAD 3855B Marking 2.5
AA 3855C / AAD 3855C Marking 2.75
AA 3855D / AAD 3855D Marking 3.0



Inamura

Capsulorhexis Forceps
Very Delicate Grasping
Tips and Extremely Thin
11mm Long
AA 3856 / AAT 3856 / AAD 3856
Curved Shanks



On Request

Inamura

Capsulorhexis Forceps
Very Delicate Grasping
Tips and Extremely Thin
11mm Long
AA 3856A / AAT 3856A / AAD 3856A
Stright Shanks



On Request

Akahoshi

Capsulorhexis Forceps
Cross Action Forceps Cross Action
Mechanism Reduces Loss of
Visco Elastic Material Through The
Incision Through Side Port Incision
Anterior Chamber Can be Better
Controlled. Capsule can Punctured
Easily and Grasp it Firmly.
AA 3860 / AAD 3860



On Request

AA - Stainless Steel, AAT - Titanium, AAD - Disposable Instruments

Utrata

Capsulorhexis Forceps
Tip Length 11mm 45° Ang.
Iris Stop Platform, 8.5 Tip
Round Handle

AA 3861 / AAT 3861 / AAD 3861

Straight Shanks

AA 3862 / AAT 3862 / AAD 3862

Curved Shanks



Pierce

Capsulorhexis Forceps
Tip Length 11mm 45° Angled Shafts
Round Handle

AA 3863 / AAT 3863 / AAD 3863



Giannetti

MICS Capsulorhexis Forceps
Ultra Delicate Shafts and Tips
Maximum Jaw Opening 2mm.
For Performing Capsulorhexis
Through a 1.5mm Incision.

AA 3864 / AAD 3864



Neyas

Capsulorhexis Forceps
Extremely Thin 11mm Long Shafts
Cystotome Shaped Tips for
Penetrating and Grasping
Anterior Capsule

AA 3865 / AAT 3865 / AAD 3865



Capsulorhexis

Forceps Straight Round Handle
With 2mm Marking
Goes Through a 1.8mm Incision.

AA 3866 / AAT 3866 / AAD 3866



Utrata

Forceps Straight Round Handle
Goes Through a 1.8mm Incision.

AA 3868 / AAT 3868 / AAD 3868 Straight

AA 3869 / AAT 3869 / AAD 3869 Curved



Masket

Capsulorhexis Forceps
Very Delicate Grasping
Tips and Extremely Thin
11mm Long Curved Shanks

AA 3870 / AAT 3870 / AAD 3870
AA 3870A / AAD 3870A Marking 2.0mm
AA 3870B / AAD 3870B Marking 2.50mm
AA 3870C / AAD 3870C Marking 2.70mm
AA 3870D / AAD 3870D Marking 3.0mm



Kreshner

Micro Incision
Capsulorhexis Forceps, Curved

AA 3871 / AAT 3871 / AAD 3871 20 G
AA 3871A / AAT 3871A / AAD 3871A 21 G
AA 3872 / AAT 3872 / AAD 3872 23 G



Jaffe

Capsulorhexis Forceps
Very Delicate, Round Grasping Tips
Extremely Thin 11mm Long Shanks

AA 3875 / AAT 3875 / AAD 3875



On Request

Buratto

Lasik Flap Forceps
Serrated & Abrasive Blasted
Inner Tip

AA 3876 / AAT 3876 / AAD 3876



Perone

Lasik Forceps
Abrasive Blasted
Inner Surface

AA 3877 / AAT 3877 / AAD 3877



Multi Purpose

Lasik Forceps
Smooth Polished
Inner Surface

AA 3878 / AAT 3878 / AAD 3878



AA - Stainless Steel, AAT - Titanium, AAD - Disposable Instruments

Jewelers

Forceps
Standard

AA 3885 / AAT 3885 / AAD 3885 # 1



Jewelers

Forceps
Delicate Short

AA 3887 / AAT 3887 / AAD 3887 # 3c



Jewelers

Forceps
Delicate

AA 3890 / AAT 3890 / AAD 3890 #3



Jewelers

Forceps
Delicate

AA 3892 / AAT 3892 / AAD 3892 #4



Jewelers

Forceps
Extra Delicate

AA 3894 / AAT 3894 / AAD 3894 #5



Jewelers

Forceps
Delicate Angled for Removal
of 9-0 and 10-0 Sutures

AA 3896 / AAT 3896 / AAD 3896 #5A



Jewelers

Forceps
Curved

AA 3898 / AAT 3898 / AAD 3898 #7



Osher

Iris Forceps
Very Fine Textured Jaws

AA 3900 / AAT 3900 / AAD 3900



AA - Stainless Steel, AAT - Titanium, AAD - Disposable Instruments

Alabama

Utility Forceps

Straight Shaft With 15mm Long
`V' Groove Tying Platform

AA 3901 / AAT 3901 / AAD 3901



Suture

Removal Forceps

Very Fine Pointed Tips

AA 3902 / AAT 3902 / AAD 3902



H.K.Punch

For Nucleus Cutting

AA 3903 / AAD 3903

Size 4.5mm Length, 15mm Angled Length

On Request



Foreign Body

Forceps

Straight, Sharp Pointed Tips

AA 3904 / AAT 3904 / AAD 3904



Akahoshi

Nucleus Fragment

Removal Forceps

Suitable for Removing
Fragments Through a
Small Incision

AA 3905 / AAD 3905

On Request



Dodick

Nucleus Cracking Forceps

The Splitter Tip is 2mm in Length
and 1mm in Height With Cross
Action and Cross Serrated, Paddle
Shaped Jaws to Divide the
Nucleus into Small Segments
During Phaco Emulsification

AA 3906 / AAT 3906 / AAD 3906



Akahoshi

Nucleus Splitter Forceps

Can be Also Used to Divide the Nucleus
After Grooving for Divide and Conquer
Technique

AA 3907 / AAD 3907

Size 9.0mm Tip Length, 4.0mm Opening Width

On Request



Kansas

Nucleus Fragment Removal Forceps
Serrated Jaws for Extracting Lens
Nucleus Fragments for Manual
Small Incision Surgery



AA 3908 / AAT 3908 / AAD 3908 Straight
AA 3909 / AAT 3909 / AAD 3909 Curved
Size 9.0mm Angled

Akahoshi

Phaco Pre Chopper
Smooth Pointed Tips to Pierce the
Nucleus and Crack for Phaco
Open to 3mm Straight Shaft,
Cross Action, Round Handle



AA 3910 / AAT 3910 / AAD 3910 Pointed Tips

Akahoshi

Smooth Flattened Pointed Tips
Open to 3mm
Round Handle for Cracking,
Dividing and Rotating the
Nucleus Without Sculpting



AA 3911 / AAT 3911 / AAD 3911 Straight

Akahoshi Phaco Prechopper

Smooth Flattened Pointed Tips
Open to 3mm
Round Handle for Cracking,
Dividing and Rotating the
Nucleus Without Sculpting



AA 3912 / AAT 3912 / AAD 3912 Angled

Akahoshi Combo Pre Chopper

For Cracking, Dividing Rotating
The Nucleus Without Sculpting



AA 3913 / AAT 3913 / AAD 3913 Straight
AA 3913A / AAT 3913A / AAD 3913A Curved

Akahoshi Phaco Pre Chopper

With Flattened Pointed Tips
AA 3914 / AAT 3914 / AAD 3914 Angled,
Gently Curved



AA - Stainless Steel, AAT - Titanium, AAD - Disposable Instruments

Bores

Incision Spreading Forceps
With 3mm Jaws Controlled Opening
0.5mm Square Jaws With
Micro Serrations

AA 3915 / AAT 3915 / AAD 3915



Inamura Eagle Pre Chopper

Enables the Division of Dens
Nucleus Without Counter Forceps

AA 3916 / AAT 3916 / AAD 3916

Size 3.5mm Tip, 1.0mm Width,
Max Open 3.0mm



Akahoshi Hybrid Pre Chopper

Sharpened Angular Edge
Improves Insertion Into the Nucleus
and Makes Nuclear Rotation Easier

AA 3917 / AAT 3917 / AAD 3917

Straight, Size 6mm Tip,
Max Open 3.0mm, 0.3mm Thickness



On Request

Akahoshi

Super Combo
Prechopper
20G, Able to Fit
Through a 1.2mm Incision

AA 3918 / AAT 3918 / AAD 3918



Akahoshi

Paddle Prechopper
Broad Blade Safely and Effectively
Prechops Soft Nuclei of Grades
1 and 2

AA 3919 / AAT 3919 / AAD 3919



Hartman

Mosquito Forceps
Extra Delicate
3.75" (95mm) Long

AA 3920 / AAT 3920 / AAD 3920 Straight

AA 3925 / AAT 3925 / AAD 3925 Curved



Allis

Tissue Forceps
Box Joint With Teeth
1x2 Teeth, 95mm
AA 3926 / AAD 3926 Straight
AA 3927 / AAD 3927 Curved



Halsted

Mosquito Forceps
Delicate
5.25" (145mm) Long
AA 3930 / AAT 3930 / AAD 3930
Straight



On Request

Artery Forceps

Mosquito Forceps
Standard
AA 3931 / AAD 3931
Big, Straight
AA 3932 / AAD 3932
Big, Curved



Halsted

Mosquito Forceps
Delicate
5.25" (145mm) Long
AA 3935 / AAT 3935 / AAD 3935 Curved



Allis

Tissue Forceps

Box Joint With Teeth

5.25" (145mm) Long

AA 3936 / AAD 3936 Straight

AA 3937 / AAD 3937 Curved



Appasamy

Cheate's Forceps

Box Joint for Lifting Instruments from Sterilizer Overall Length 200mm

AA 3938 / AAD 3938



Backhaus

Towel Clamp

AA 3940 / AAD 3940 3.5" (90mm) Long

AA 3942 / AAD 3942 5.25" (135mm) Long



Baby Jones

Towel Clamp Forceps

Cross-Action

2.25" (55mm) Long

AA 3945 / AAD 3945



Appasamy

Sponge Holding Forceps
Box Joint Serrated Jaws
Overall Length 200mm
AA 3946 / AAD 3946



Ring Type Needle Holder
AA 3947 / AAD 3947



Serrefine

Serrated Jaws
1.5"(38mm) Long
AA 3950 / AAD 3950 Straight
AA 3952 / AAD 3952 Curved



Vitreous Forceps

Smooth Jaws, Straight
AA 3960 / AAT 3960 / AAD 3960 20 G
AA 3960A / AAT 3960A / AAD 3960A 23 G



Diamondized Gripping Forceps

Forceps Straight
AA 3961 / AAT 3961 / AAD 3961 20 G
AA 3961A / AAT 3961A / AAD 3961A 23 G
AA 3961B / AAT 3961B / AAD 3961B 25 G
AA 3961C / AAT 3961C / AAD 3961C 27 G



AA - Stainless Steel, AAT - Titanium, AAD - Disposable Instruments

Vitreous Forceps

With Fiber Optic

AA 3962 / AAT 3962 / AAD 3962 18 G



Crocodile Gripping Forceps

AA 3963 / AAT 3963 / AAD 3963 20 G



Vitreous Forceps

Serrated Jaws, Straight

AA 3965 / AAT 3965 / AAD 3965 20 G

AA 3965A / AAT 3965A / AAD 3965A 23 G



Vitreous Forceps

Smooth Jaws, 1x2 Teeth Straight

AA 3970 / AAT 3970 / AAD 3970 20 G



End Gripping Forceps

AA 3971 / AAT 3971 / AAD 3971 20 G

AA 3971A / AAT 3971A / AAD 3971A 23 G



End Gripping Forceps

With Micro Jaws,

AA 3972 / AAT 3972 / AAD 3972 20 G

AA 3972A / AAT 3972A / AAD 3972A 23 G



Vitreous Forceps

Smooth Jaws, 0.3mm Platform, Straight

AA 3975 / AAT 3975 / AAD 3975 20 G

AA 3975A / AAT 3975A / AAD 3975A 23 G



Pick Forceps

AA 3976 / AAT 3976 / AAD 3976 20 G
AA 3976A / AAT 3976A / AAD 3976A 23 G
AA 3976B / AAT 3976B / AAD 3976B 25 G



Appa Pick Forceps

AA 3977 / AAT 3977 / AAD 3977 20 G



Gripping Angled Forceps

AA 3978 / AAT 3978 / AAD 3978 20 G



Sub Retinal Forceps

AA 3979 / AAT 3979 / AAD 3979 20 G



Vitreous Forceps

Smooth Jaws, Vertical

AA 3980 / AAT 3980 / AAD 3980 20 G
AA 3980A / AAT 3980A / AAD 3980A 23 G



Vitreous Forceps

30° Ang Jaws

AA 3981 / AAT 3981 / AAD 3981 23 G
AA 3981A / AAT 3981A / AAD 3981A 25 G
AA 3981B / AAT 3981B / AAD 3981B 27 G



Asymmetrical

End Gripping Forceps

AA 3982 / AAT 3982 / AAD 3982 20 G
AA 3982A / AAT 3982A / AAD 3982A 23 G
AA 3982B / AAT 3982B / AAD 3982B 25 G



AA - Stainless Steel, AAT - Titanium, AAD - Disposable Instruments

Tanaka

Maculohexis Forceps

AA 3983 / AAT 3983 / AAD 3983 23 G



Kawai

ILM Forceps,

AA 3984 / AAT 3984 / AAD 3984 25G



Vitreous

Forceps

AA 3985 / AAT 3985 / AAD 3985 20 G



ILM Forceps

AA 3986 / AAT 3986 / AAD 3986 20 G

AA 3986A / AAT 3986A / AAD 3986A 23 G



Lens Cartridge

Loading Forceps ICL

AA 3987 / AAT 3987 / AAD 3987 23 G

AA 3987A / AAT 3987A / AAD 3987A 25 G

AA 3987B / AAT 3987B / AAD 3987B 27 G



Foreign Body Forceps

AA 3988 / AAT 3988 / AAD 3988 17 G



Vitreoretinal Forceps

With Cup Jaws

AA 3989 / AAT 3989 / AAD 3989 20 G



Iridectomy Forceps

Designed to Perform Caspsulorhexis

Through 0.8mm Side-Port Incision

Straight 23 Gauge Shaft

Delicate Tips

With Lock

Compatible with Squeeze Handle

AA 3990 / AAT 3990 / AAD 3990



AA - Stainless Steel, AAT - Titanium, AAD - Disposable Instruments

Spring Gripping Forceps

AA 3991 / AAT 3991 / AAD 3991 20 G
AA 3991A / AAT 3991A / AAD 3991A 23 G



Large Foreign Body Forceps

AA 3992 / AAT 3992 / AAD 3992 20 G



Endothelial Gripping Forceps

AA 3993 / AAT 3993 / AAD 3993 20 G



Agarwal Glued IOL Forceps

AA 3995 / AAT 3995 / AAD 3995 Straight 20 G
AA 3996 / AAT 3996 / AAD 3996 Curved 20 G



- ★ Corneoscleral Scissors
- ★ Conjunctiva Scissors
- ★ Vannas Scissors
- ★ Vitreous Scissors
- ★ Eye Scissors
- ★ Enucleation Scissors

Castroviejo

Corneoscleral Scissors
Small Blades

AA 4010 / AAT 4010 / AAD 4010 Left
Blade length 9mm



Castroviejo

Corneoscleral Scissors
Small Blades

AA 4015 / AAT 4015 / AAD 4015 Right
Blade length 9mm



Castroviejo

Corneoscleral Scissors
Medium Blades

AA 4020 / AAT 4020 / AAD 4020 Left
Blade length 9mm



Castroviejo

Corneoscleral Scissors
Medium Blades

AA 4025 / AAT 4025 / AAD 4025 Right
Blade length 9mm



Troutman-Katzin

Corneal Transplant Scissors
Strong Curve

6mm Long blades
AA 4030 / AAD 4030 Left
Blade length 10mm



Troutman-Katzin

Corneal Transplant Scissors
Strong Curve

6mm Long blades
AA 4035 / AAD 4035 Right
Blade length 10mm



AA - Stainless Steel, AAT - Titanium, AAD - Disposable Instruments

Castroviejo

Corneal Scissors
Curved Blunt Tips

AA 4040 / AAT 4040 / AAD 4040

Small Blades 9mm Length

AA 4045 / AAT 4045 / AAD 4045

Medium Blades 11mm Length



Castroviejo

Corneal Scissors
Curved Blunt Tips

AA 4050 / AAT 4050 / AAD 4050

Large Blades 13mm Length



Castroviejo

Corneal Transplant Scissors
Strong Curve & Large Blades

AA 4060 / AAT 4060 / AAD 4060

Blade length 13mm



Castroviejo

Keratoplasty Scissors
Angled to Side

Blunt Tips

Small Blades

AA 4065 / AAT 4065 / AAD 4065

Blade length 9mm

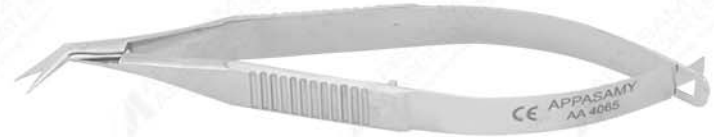

Castroviejo

Keratoplasty Scissors
Angled to Side

Blunt Tips

Medium Blades

AA 4070 / AAT 4070 / AAD 4070

Blade length 9mm



Micro

Iris Scissors
Pointed Tips

AA 4095 / AAT 4095 / AAD 4095 Straight

AA 4096 / AAT 4096 / AAD 4096 Curved

Blade length 10mm



Micro

Corneal Scissors
Curved, Pointed Tips
Small Blades
AA 4100 / AAT 4100 / AAD 4100
Blade length 9mm



Micro

Corneal Scissors
Curved, Pointed Tips
Medium Blades
AA 4105 / AAT 4105 / AAD 4105
Blade length 11mm



Micro

Corneal Scissors
Half Curved, Long Blades, 12mm
AA 4107 / AAT 4107 / AAD 4107



Micro

Iris Scissors
Curved, Pointed Tips
Large Blades
AA 4110 / AAT 4110 / AAD 4110
Blade length 14mm



Micro

Iris Scissors
Strong Curved,
Pointed Tips
Small Blades
AA 4115 / AAT 4115 / AAD 4115
Blade length 12mm



Barraquer

Iris Scissors
Blunt Tips
7mm Long Blades
AA 4120 / AAD 4120



De-Wecker

Iris Scissors

AA 4125 / AAD 4125 Sharp-Blunt

AA 4126 / AAD 4126 Sharp-Sharp

AA 4127 / AAD 4127 Blunt-Blunt

Blade length 12mm

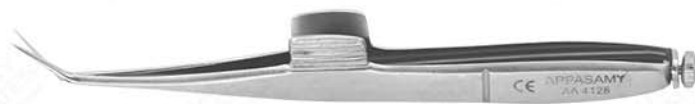

Mc-Pherson Westcott

Conjunctival Scissors

Curved, Blunt Tips

Small Blades

AA 4150 / AAT 4150 / AAD 4150

Blade length 12mm



Westcott

Tenotomy Scissors

Curved, Blunt Tips

Medium Blades

AA 4155 / AAT 4155 / AAD 4155

Blade length 16mm



Westcott

Tenotomy Scissors

Curved, Blunt Tips

Standard Blades

AA 4160 / AAT 4160 / AAD 4160 Left

AA 4165 / AAT 4165 / AAD 4165 Right

Blade length 23mm

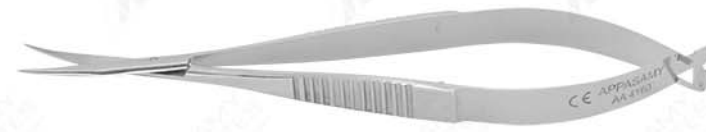

Mc Pherson- Westcott

Stitch Scissors

Very Sharp Pointed Tips

Small Blades Curved

AA 4170 / AAT 4170 / AAD 4170

Blade length 11mm



Jaffe

Stitch Scissors

Very Sharp Pointed Tips

Medium Blades Curved

AA 4175 / AAT 4175 / AAD 4175

Blade length 13mm



Westcott

Tenotomy Scissors

Curved, Blunt Tips

Standard Blades Curved

AA 4180 / AAT 4180 / AAD 4180

Blade length 23mm



Westcott

Tenotomy Scissors

Curved, Blunt Tips

Medium Blades Curved

AA 4180A / AAT 4180A / AAD 4180A

Blade length 23mm



Fine

Stitch Scissors

Sharp Tips

Medium Blades

AA 4195 / AAT 4195 / AAD 4195 Straight

Blade length 14mm



Vannas

Capsulotomy Scissors

Sharp Tips

AA 4250 / AAT 4250 / AAD 4250 Straight

AA 4255 / AAT 4255 / AAD 4255 Curved

Blade length 9mm



Appasamy

Capsule Tag Scissors

15mm Long Spatulated

Gently Curved Blunt Tip Blades

For Cutting Capsule Tags and

Anterior Capsulotomy

AA 4260 / AAT 4260 / AAD 4260 Short Handle 12mm length

AA 4265 / AAT 4265 / AAD 4265 Long Handle 16mm length



Vannas

Capsulotomy Scissors

Sharp Tips

AA 4270 / AAT 4270 / AAD 4270 Angled

Forward 9mm Blades



Vannas

Capsulotomy Scissors

Sharp Tips

AA 4275 / AAT 4275 / AAD 4275 Angled

Forward 11mm Blades



Vannas

Capsulotomy Scissors

Sharp Tips

AA 4280 / AAT 4280 / AAD 4280

Angled to Side

Blade length 7.5mm



Gills-Vannas

Capsulotomy Scissors

Extra Thin Long Blades

Sharp Tips

AA 4285 / AAT 4285 / AAD 4285 Straight

Blade Length 8mm

AA 4290 / AAT 4290 / AAD 4290 Curved

Blade length 8mm

AA 4295 / AAT 4295 / AAD 4295 Angled Forward

Blade length 10mm



Mc pherson-Vannas

Iris Scissors

Sharp Tips

AA 4300 / AAT 4300 / AAD 4300 Curved

Blade length 8mm



DALK Scissors

Blunt, 4.5mm Angled Blades

AA 4335 / AAT 4335 / AAD 4335



Stern-Gills

Capsulotomy Scissors

Extra Thin

10mm Long Blades

AA 4350 / AAT 4350 / AAD 4350



Hoffer-Stern

Capsulotomy Scissors

Extra Thin, 10mm Long Curved
Blades, Convex

AA 4355 / AAT 4355 / AAD 4355



Uribe-Stern

Capsulotomy Scissors

Extra Thin, 10mm Long Curved
Blades, Concave

AA 4365 / AAT 4365 / AAD 4365



AA - Stainless Steel, AAT - Titanium, AAD - Disposable Instruments

Koch

Endocapsular Scissors
Extra Thin, 10mm Long Delicate
Curved Blades

AA 4370 / AAT 4370 / AAD 4370



Vannas

Long Handle Scissors
Extra Thin, 10mm Long Blades
Sharp Points

AA 4375 / AAT 4375 / AAD 4375



Appasamy

Intraocular Scissors
Squeeze Handle, Protective Cap
17Gauge to Cut Capsular Tags
AA 4400 / AAD 4400 Straight
AA 4410 / AAD 4410 Curved
Blade length 7mm



On Request

Scimeca

Lens Loop Amputator
For Cutting Poly Propylene
or PMMA Lens Haptics in the
Anterior or Posterior Chamber
AA 4420 / AAD 4420 Left
AA 4425 / AAD 4425 Right
Blade length 3mm



On Request

Vitreous

Scissors
Straight Jaws
AA 4450 / AAT 4450 / AAD 4450 20 G
Blade length 5mm
AA 4450A / AAT 4450A / AAD 4450A 23 G
Blade length 3mm
AA 4451 / AAT 4451 / AAD 4451 20 G
With Irrigation
Blade length 5mm



Vitreous

Scissors
Angled Jaws 30°
AA 4460 / AAT 4460 / AAD 4460 20 G
AA 4461 / AAT 4461 / AAD 4461 20 G
With Irrigation
Blade length 3mm



AA - Stainless Steel, AAT - Titanium, AAD - Disposable Instruments

Vitreous

Scissors

Vertical Cut 60°

AA 4470 / AAT 4470 / AAD 4470 20 G

AA 4470A / AAT 4470A / AAD 4470A 23 G

AA 4471 / AAT 4471 / AAD 4471 20 G

With Irrigation

Blade length 3mm



Vitreous

Scissors

Vertical Cut 90°

AA 4480 / AAT 4480 / AAD 4480 20 G

AA 4480A / AAT 4480A / AAD 4480A 23 G

AA 4481 / AAT 4481 / AAD 4481 20 G

With Irrigation

Blade length 3mm



Iris Scissors

Delicate Pointed Tips

Ring Handle Straight

AA 4500 / AAD 4500 3.5" Length

AA 4501 / AAD 4501 4.0" Length



Iris Scissors

Delicate Pointed Tips

Ring Handle Curved

AA 4505 / AAD 4505 3.5" Length

AA 4506 / AAD 4506 4.0" Length



Eye Scissors

Delicate Pointed Tips

Ring Handle Straight

AA 4510 / AAD 4510 4.5" Length

AA 4511 / AAD 4511 5.0" Length



Eye Scissors

Delicate Pointed Tips

Ring Handle Curved

AA 4515 / AAD 4515 4.5" Length

AA 4516 / AAD 4516 5.0" Length



Stitch Scissors

Needle Points

Ring Handle

AA 4520 / AAD 4520 Straight

AA 4525 / AAD 4525 Curved

Blade length 25mm



Stevens

Tenotomy Scissors

Blunt Tips, Ring Randle

AA 4530 / AAD 4530 Straight

Blade length 25mm



Stevens

Tenotomy Scissors

Blunt Tips, Ring Handle

AA 4535 / AAD 4535 Curved

Blade length 25mm



Knapp
Strabismus Scissors
Blunt Tips, Ring Handle
AA 4550 / AAD 4550 Straight
AA 4555 / AAD 4555 Curved
Blade length 28mm



Enucleation Scissors
Ring Handle
AA 4575 / AAD 4575 Straight
Blade length 40mm



Enucleation Scissors
Ring Handle
AA 4580 / AAD 4580 Medium Curve
Blade length 40mm



Enucleation Scissors
Ring Handle
AA 4585 / AAD 4585 Strong Curve
Blade length 40mm



Mayo Scissors

Straight Overall length 5.5"

AA 4590 / AAD 4590

Curved Overall length 5.5"

AA 4595 / AAD 4595



Vertical Scissors

AA 4600 / AAT 4600 / AAD 4600 45° 25 G



Vertical Scissors

AA 4605 / AAT 4605 / AAD 4605 55° 20 G



Horizontal Scissors

45°, Regular Blades

AA 4610 / AAT 4610 / AAD 4610 20 G



Horizontal Scissors

45°, Short Blades

AA 4615 / AAT 4615 / AAD 4615 20 G



Horizontal Scissors

Sub Retinal Scissors Curved

AA 4620 / AAT 4620 / AAD 4620 23 G



AA - Stainless Steel, AAT - Titanium, AAD - Disposable Instruments

★ Superior Rectus Needle Holder

★ Castroviejo Needle Holder

★ Barraquer Needle Holder

★ Blades

★ Punches

★ Lacrimal Instruments

On Request

Arruga

Needle Holder

AA 5010 / AAT 5010 / AAD 5010 Straight
AA 5015 / AAT 5015 / AAD 5015 Curved



Kalt

Needle Holder

AA 5020 / AAT 5020 / AAD 5020 Straight
AA 5025 / AAT 5025 / AAD 5025 Curved



On Request

Silcock

Needle Holder

AA 5030 / AAT 5030 / AAD 5030



On Request

Mc Pherson

Needle Holder

Very Delicate Jaws

AA 5040 / AAT 5040 / AAD 5040 Straight, With Lock
AA 5045 / AAT 5045 / AAD 5045 Straight, Without Lock
AA 5046 / AAT 5046 / AAD 5046 (Short Model) Straight, Without Lock
AA 5050 / AAT 5050 / AAD 5050 Curved, With Lock
AA 5055 / AAT 5055 / AAD 5055 Curved, Without Lock
AA 5058 / AAT 5058 / AAD 5058 110mm With Lock Straight



Castroviejo

Needle Holder

Delicate Jaws

Ideal for 7-0 to 9-0 Sutures

AA 5060 / AAT 5060 / AAD 5060 Straight, With Lock
AA 5065 / AAT 5065 / AAD 5065 Straight, Without Lock
AA 5065A / AAT 5065A / AAD 5065A
(Short Model) Straight, Without Lock
AA 5070 / AAT 5070 / AAD 5070 Curved, With Lock
AA 5070A / AAT 5070A / AAD 5070A
(Short Model) Curved, With Lock
AA 5075 / AAT 5075 / AAD 5075 Curved, Without Lock
AA 5075A / AAT 5075A / AAD 5075A
(Short Model) Curved, Without Lock



AA - Stainless Steel, AAT - Titanium, AAD - Disposable Instruments

Castroviejo

Needle Holder
Standard Jaws

Ideal for 4-0 to 7-0 Sutures

AA 5080 / AAT 5080 / AAD 5080 Straight, With Lock

AA 5085 / AAT 5085 / AAD 5085 Straight, Without Lock

AA 5085A / AAT 5085A / AAD 5085A

(Short Model) Straight, Without Lock

AA 5090 / AAT 5090 / AAD 5090 Curved, With Lock

AA 5095 / AAT 5095 / AAD 5095 Curved, Without Lock



Drews

Needle Holder

Extra Delicate Jaws

AA 5100 / AAT 5100 / AAD 5100 Straight, With Lock

AA 5105 / AAT 5105 / AAD 5105 Straight, Without Lock

AA 5110 / AAT 5110 / AAD 5110 Curved, With Lock

AA 5115 / AAT 5115 / AAD 5115 Curved, Without Lock



Barriquer

Needle Holder

Short Model

Very Delicate Jaws

AA 5120 / AAT 5120 / AAD 5120 Straight, With Lock

AA 5125 / AAT 5125 / AAD 5125 Straight, Without Lock

AA 5130 / AAT 5130 / AAD 5130 Curved, With Lock

AA 5135 / AAT 5135 / AAD 5135 Curved, Without Lock



Barriquer

Needle Holder

Short Model

Micro Jaws

Ideal for 10-0 to 11-0 Sutures

AA 5140 / AAT 5140 / AAD 5140 Micro, With Lock

AA 5145 / AAT 5145 / AAD 5145 Micro, Without Lock



Barraquer

Needle Holder

Very Delicate Jaws

Ideal for 8-0 to 11-0 Sutures

AA 5150 / AAT 5150 / AAD 5150 Straight, With Lock

AA 5155 / AAT 5155 / AAD 5155 Straight, Without Lock

AA 5160 / AAT 5160 / AAD 5160 Curved, With Lock

AA 5165 / AAT 5165 / AAD 5165 Curved, Without Lock



Barraquer

Needle Holder

Extra Delicate, Micro Jaws

Ideal for 10-0 to 11-0 Sutures

AA 5170 / AAT 5170 / AAD 5170 Micro, With Lock

AA 5175 / AAT 5175 / AAD 5175 Micro, Without Lock



Barraquer

Needle Holder

Standard, Micro Jaws

Ideal for 10-0 to 11-0 Sutures

AA 5176 / AAT 5176 / AAD 5176 Micro, With Lock

AA 5177 / AAT 5177 / AAD 5177 Micro, Without Lock



Barraquer

Needle Holder

Standard Jaws, Curved

Ideal for 4-0 to 7-0 Sutures

AA 5180 / AAT 5180 / AAD 5180 Curved, With Lock

AA 5185 / AAT 5185 / AAD 5185 Curved,

Without Lock



Troutman

Needle Holder

Delicate, Strongly Curved Jaws

Ideal for 8-0 to 11-0 Sutures

AA 5190 / AAT 5190 / AAD 5190 With Lock

AA 5195 / AAT 5195 / AAD 5195 Without Lock



Anis

Needle Holder
Extra Delicate Jaws

- AA 5200 / AAT 5200 / AAD 5200 Straight, With Lock
- AA 5205 / AAT 5205 / AAD 5205 Straight, Without Lock
- AA 5210 / AAT 5210 / AAD 5210 Curved, With Lock
- AA 5215 / AAT 5215 / AAD 5215 Curved, Without Lock



Mc Intyre

Fish Hook Needle Holder
Straight

- AA 5220 / AAT 5220 / AAD 5220 With Lock
- AA 5225 / AAT 5225 / AAD 5225 Without Lock



Castroviejo

Blade Breaker and Holder

- AA 5400 / AAT 5400 / AAD 5400 Small (90mm)
- AA 5405 / AAT 5405 / AAD 5405 Big (120mm)

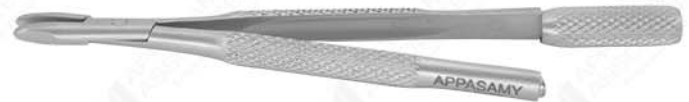

Swiss Model

Blade Breaker and Holder
Pencil Type

- AA 5420 / AAT 5420 / AAD 5420 Small (90mm)
- AA 5425 / AAT 5425 / AAD 5425 Big (120mm)

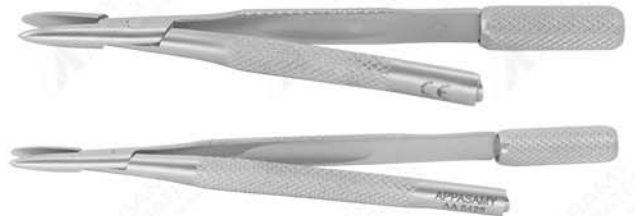

Troutman

Micro Blade Holder

- AA 5430 / AAD 5430 Straight
- AA 5435 / AAD 5435 Angled



On Request

Barraquer

Blade Breaker and Holder
Flat Handle With Spring Lock
AA 5450 / AAD 5450 Straight



On Request

Bard-Parker Handle

For Disposable Slot Blades

AA 5460 / AAT 5460 / AAD 5460 #3 Flat Handle

AA 5465 / AAT 5465 / AAD 5465 #3 Round Handle



Chuck Handle

For Holding Micro Wire Blades

AA 5475 / AAT 5475 / AAD 5475



Bard-Parker Blade

AA 5560 / AAD 5560 #11 Blade

AA 5561 / AAD 5561 #15 Blade



Carbon Razor Blade

AA 5570 / AAD 5570



Pre-Cut

Micro Blade Fragments

AA 5575 / AAD 5575 30° Angled

AA 5578 / AAD 5578 45° Angled

AA 5579 / AAD 5579 60° Angled



Eye Shield

Post Operative - Opaque

Plastic Green colour

Non Autoclave

AA 5580 / AAD 5580



AA - Stainless Steel, AAT - Titanium, AAD - Disposable Instruments

Incisional instruments

Dissection Knife

0.5 mm, Straight

AA 5650



Sclerotomy Knife

2.5 mm, Straight

AA 5651



Specialty Knives

Subretinal Spatula 1.75 mm Length

45° Angled

Subretinal Spatula 2.50 mm Length

55° Angled

AA 5652



Specialty Knives

Membrane Delamination knife

AA 5653



Scleral pocket knives

2.9mm, 60° Angled, Dual Bevel

2.9mm, 60° Angled, Bevel Down

1.2 mm, 35° Mini-Disk, Angled, Dual Bevel

1.0 mm, Straight, Mini-Disk, Bevel Up.

AA 5654



CLEAR CORNEAL BLADE



AA 555026	W=2.6mm	Double Bevel	AA 555028	W=2.8mm	Double Bevel
AA 555030	W=3.0mm	Double Bevel	AA 555032	W=3.2mm	Double Bevel



TRAPEZOID SLIT BLADE

AA 554015	W=1.5/2.0mm	Bevel up	AA 554028	W=2.8/3.2mm	Bevel up



SCLERAL KNIFE(HOCKEY KNIFE)

	Specifications			Product No.
	Blade width	Bevel	Blade thickness	PC Handle
	Scleral knife, straight	Bi-bevel	0.38mm	AA 2400



PARACENTESIS KNIFE

	1.0mm



LANCE BLADE (SIDE PORT BLADE)



AA 550009	Angle 15°	T=0.18mm	AA 550012	Angle 15°	T=0.18mm
AA 550015	Angle 15°	T=0.18mm			



TUNNEL BLADE

AA 551021	W=2.1mm	Bevel up	AA 551026	W=2.6mm	Bevel up



SLIT BLADE (ENTRY KERATOME BLADE)

AA 552016	W=1.6mm	Bevel up	AA 552018	W=1.8mm	Bevel up
AA 552026	W=2.6mm	Bevel up	AA 552028	W=2.8mm	Bevel up
AA 552030	W=3.0mm	Bevel up	AA 552032	W=3.2mm	Bevel up



SLIT ENLARGE BLADE

AA 553050	W=5.0mm	Bevel up	AA 553051	W=5.1mm	Bevel up
AA 553052	W=5.2mm	Bevel up	AA 553055	W=5.5mm	Bevel up





STAB KNIVES (LANCE)

CATALOGUE NO	TYPE
AA 590012	15°, 1.2 mm
AA 590015	15°, 1.5 mm



CRESCENT KNIVES (TUNNEL)

CATALOGUE NO	TYPE
AA 591021	2.1 mm Bevel up
AA 591026	2.6 mm Bevel up

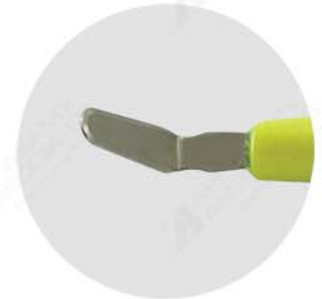

SLIT KNIFE

CATALOGUE NO	TYPE
AA 592014	1.4 mm Bevel up
AA 592018	1.8 mm Bevel up
AA 592020	2.0 mm Bevel up
AA 592022	2.2 mm Bevel up
AA 592024	2.4 mm Bevel up
AA 592028	2.8 mm Bevel up
AA 592030	3.0 mm Bevel up
AA 592032	3.2 mm Bevel up



IMPLANT KNIVES (SLIT ENLARGE)

CATALOGUE NO	TYPE
AA 593050	5.0 mm Bevel up
AA 593052	5.2 mm Bevel up
AA 593055	5.5 mm Bevel up



LANCE BLADE (SIDE PORT BLADE)



- AA 560009 15° Straight 0.9 mm AA 560209 45° Straight 0.9 mm
- AA 560012 15° Straight 1.2 mm AA 560212 45° Straight 1.2 mm



TUNNEL BLADE (CRESCENT BLADE)



- AA 561021 2.1 mm Angled Bevel up
- AA 561026 2.6 mm Angled Bevel up



SLIT BLADE (ENTRY KERATOME BLADE)



- AA 562014 1.4 mm Angled Bevel up AA 562027 2.7 mm Angled Bevel up
- AA 562018 1.8 mm Angled Bevel up AA 562028 2.8 mm Angled Bevel up
- AA 562020 2.0 mm Angled Bevel up AA 562030 3.0 mm Angled Bevel up
- AA 562022 2.2 mm Angled Bevel up AA 562032 3.2 mm Angled Bevel up
- AA 562026 2.6 mm Angled Bevel up



SLIT ENLARGE BLADE (IOL IMPLANT BLADE)



- AA 563050 5.0 mm Angled Bevel up
- AA 563052 5.2 mm Angled Bevel up
- AA 563055 5.5 mm Angled Bevel up



MVR VITRECTOMY BLADE



- AA 564019 19Gauge 1.0 mm Wide AA 564119 19Gauge 1.0 mm Angled
- AA 564020 20Gauge 0.9 mm Wide AA 564120 20Gauge 0.9 mm Angled
- AA 564023 23Gauge 0.8 mm Wide AA 564123 23Gauge 0.8 mm Angled



Lance Blade (Side Port Blade)

- AA 570009 15° Straight 0.9mm
- AA 570012 15° Straight 1.2mm
- AA 570015 15° Straight 1.5mm



Tunnel Blade

- AA 571021 2.1mm angled Bevel up
Stainless
- AA 571026 2.6mm angled Bevel up
Stainless



Ultra Thin Phacolit Blade

- AA 572014 Width 1.4mm
- AA 572018 Width 1.8mm



Slit Blade (Entry Keratome Blade)

- AA 572028 2.8mm Angled Bevel up
- AA 572030 3.0mm Angled Bevel up
- AA 572032 3.2mm Angled Bevel up



Slit Enlarge Blade (IOL Implant Blade)

- AA 573050 5.0mm Angled Bevel up
- AA 573052 5.2mm Angled Bevel up
- AA 573055 5.5mm Angled Bevel up



Slit Enlarge Blade (IOL Implant Blade)

- AA 575300 300µm
- AA 575350 350µm
- AA 575500 500µm
- AA 575550 550µm
- AA 575600 600µm



Kerrison

Bone Nibbling Ronguer
9mm Opening

- AA 6010 / AAD 6010 Size 0, 1mm Wide
- AA 6011 / AAD 6011 Size 1, 2mm Wide
- AA 6012 / AAD 6012 Size 2, 3mm Wide
- AA 6013 / AAD 6013 Size 3, 4mm Wide
- AA 6014 / AAD 6014 Size 4, 5mm Wide



Citeli

Bone Nibbling Ronguer Small

- AA 6020 / AAD 6020 Size 0, 2mm Wide
- AA 6021 / AAD 6021 Size 1, 3mm Wide
- AA 6022 / AAD 6022 Size 2, 4mm Wide



Beyer

Bone Nibbling Ronguer

- AA 6030 / AAD 6030 Single Action
- AA 6035 / AAD 6035 Double Action



Nasal

Speculum

- AA 6040 / AAD 6040 Infant
- AA 6041 / AAD 6041 Child
- AA 6042 / AAD 6042 Adult



Tilley

Nasal Packing Forceps

- AA 6045 / AAD 6045 Infant



On Request

Holth

Corneoscleral punch
9mm Opening

AA 6050 / AAD 6050 1mm

AA 6051 / AAD 6051 1.5mm

AA 6052 / AAD 6052 2mm



On Request

Gass

Corneoscleral Punch
1.5mm Dia. Tip Rotatable for
Convenient Positioning

AA 6060 / AAD 6060



Kelly's

Descemet's Membrane Punch

AA 6070 / AAT 6070 / AAD 6070 1mm

AA 6071 / AAT 6071 / AAD 6070 0.75mm



Arruga

Lacrimal Trephine

'T' Handle With Sharp

Cutting Edge, Used

for Cutting the Bone With Pin for Primary

Without Pin for Secondary

AA 6080 / AAD 6080 7mm, With Centre Pin

AA 6081 / AAD 6081 8mm, With Centre Pin

AA 6082 / AAD 6082 9mm, With Centre Pin

AA 6083 / AAD 6083 10mm, With Centre Pin

AA 6085 / AAD 6085 7mm, Without Centre Pin

AA 6086 / AAD 6086 8mm, Without Centre Pin

AA 6087 / AAD 6087 9mm, Without Centre Pin

AA 6088 / AAD 6088 10mm, Without Centre Pin



Arruga

Lacrimal Trephine
Used for Cutting The
Bone With Pin for Primary
Without Pin for Secondary

- AA 6090 / AAD 6090 7mm, With Centre Pin
- AA 6091 / AAD 6091 8mm, With Centre Pin
- AA 6092 / AAD 6092 9mm, With Centre Pin
- AA 6093 / AAD 6093 10mm, With Centre Pin
- AA 6095 / AAD 6095 7mm, Without Centre Pin
- AA 6096 / AAD 6096 8mm, Without Centre Pin
- AA 6097 / AAD 6097 9mm, Without Centre Pin
- AA 6098 / AAD 6098 10mm, Without Centre Pin



West

Lacrimal Chisel

- AA 6100 / AAT 6100 / AAD 6100 Straight
- AA 6105 / AAT 6105 / AAD 6105 Curved



West

Bone Gouge

- AA 6110 / AAT 6110 / AAD 6110 Straight



Mallet

For DCR

- AA 6120 / AAD 6120



Freer

Periosteal Elevator
One End Blunt
Other End Semi-Sharp
4.5mm Wide Blades

- AA 6130 / AAT 6130 / AAD 6130



Traquair

Periosteal Elevator

- AA 6140 / AAT 6140 / AAD 6140



Pigtail

Probe

With Suture Holes
for Lower Punctum and
Upper Punctum

- AA 6150 / AAT 6150 / AAD 6150



AA - Stainless Steel, AAT - Titanium, AAD - Disposable Instruments

Harms

Trabeculotomy Probe
Radius 7mm

AA 6160 / AAT 6160 / AAD 6160 Right
AA 6170 / AAT 6170 / AAD 6170 Left



Bowman

Lacrimal Probe
Malleable Stainless Steel

AA 6175 / AAD 6175 Set of 4 Sizes
AA 6180 / AAD 6180 Size 0000&000
AA 6190 / AAD 6190 Size 00&0
AA 6200 / AAD 6200 Size 1&2
AA 6210 / AAD 6210 Size 3&4
AA 6212 / AAD 6212 Size 5&6
AA 6214 / AAD 6214 Size 7&8

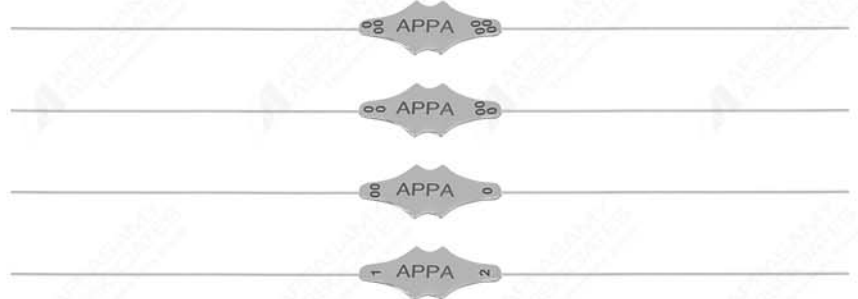

Jackson

Lacrimal Intubation Set
Includes 2 Blunt Stainless Steel
Probes, 0.9mm Dia X 150mm Long,
Supplied With 300mm long Silicone
Tubing 0.30mm I.D X 0.60mm O.D.

AA 6220 / AAD 6220 Set
AA 6225 / AAD 6225 Silicone Tubing

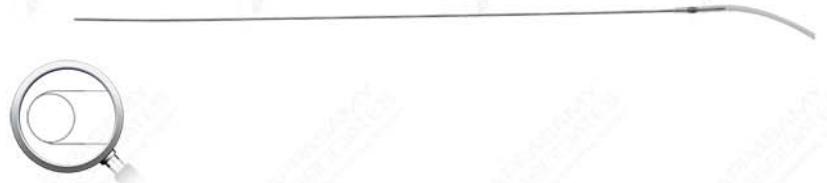

Bodian

Lacrimal Probe Set Includes 2 curved, Blunt
Stainless Steel Probes 1.0mm DiaX35mm Long
Supplied With 300mm Long Silicone Tubing
0.30mm I.DX0.60 O.D.

AA 6230 / AAD 6230 Set
AA 6235 / AAD 6235 Silicone Tubing



Crawford

Lacrimal Intubation Includes two
Olive Tip Stainless Steel Probes
0.6mm DiaX 150mm Long
Supplied With 300mm Long Silicone Tubing,
0.50mm I.D X 0.94mm O.D.

AA 6240 / AAD 6240 Set
AA 6242 / AAD 6242 Silicone Tubing
AA 6245 / AAD 6245 Retrieving Hook

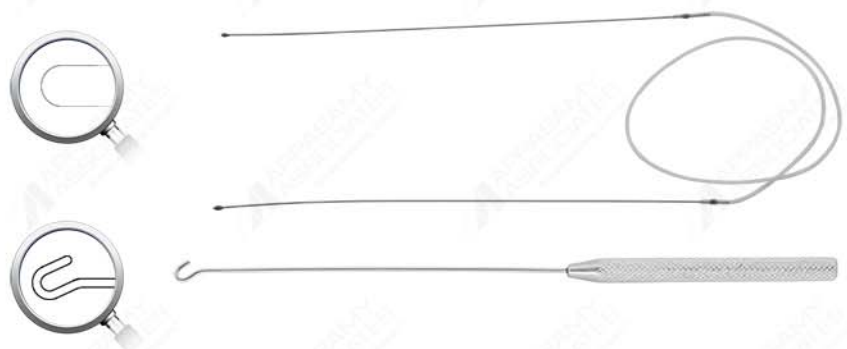

AA - Stainless Steel, AAT - Titanium, AAD - Disposable Instruments

Catalano

Lacrimal Intubation Set

Includes Two Blunt Stainless Steel Probes,
0.7mm Dia x 140mm Long, Supplied With
300mm Long Silicone Tubing
0.30mm I.D x 0.60mm O.D

AA 6250 / AAD 6250 Set

AA 6255 / AAD 6255 Silicone Tubing

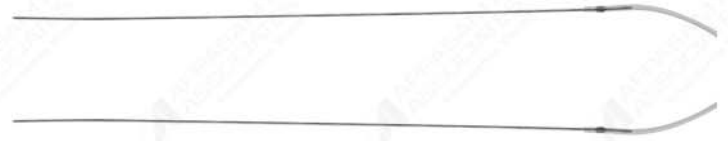

Naso-Lacrimal Probe

With Irrigating Side Port

Blunt Tip Supplied With

Silicone Tubing and Adaptor

AA 6260 / AAD 6260 0.5mm Diameter

AA 6261 / AAD 6261 0.6mm Diameter

AA 6262 / AAD 6262 0.8mm Diameter

AA 6265 / AAD 6265 Silicone Tubing



Infant

Lacrimal Dilator

Very Fine Blunt Tip

AA 6400 / AAT 6400 / AAD 6400

0.5mm Diameter



Muldoon

Lacrimal Dilator

Graduated Blunt Tip

AA 6405 / AAT 6405 / AAD 6405

0.5mm Diameter



Wilder

Lacrimal Dilator

AA 6410 / AAT 6410 / AAD 6410

size 1, Fine Taper

AA 6420 / AAT 6420 / AAD 6420

size 2, Medium Taper

AA 6430 / AAT 6430 / AAD 6430

size 3, Heavy Taper



Castroviejo

Lacrimal Dilator

Double-End

Fine and Medium Taper

AA 6440 / AAT 6440 / AAD 6440



★ Air Cannula

★ Hydrodissection Cannula

★ Hydrodelineation Cannula

★ I/A Cannula

★ Lasik Cannula

★ Sterilization Boxes

★ Vitreo-Retinal Instruments

Needle

AA 7001 / AAD 7001 18G
AA 7002 / AAD 7002 20G
AA 7003 / AAD 7003 23G

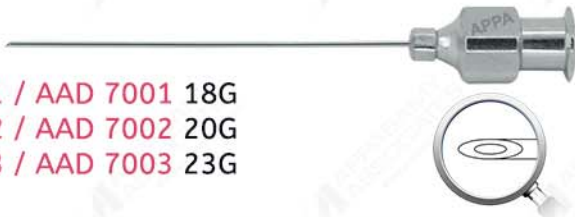

Mc Intyre

Lacrimal Cannula
Blunt Tip 0.3mm Side Port
Overall Length 46mm, 23 G
AA 7005 / AAD 7005 Straight
AA 7007 / AAD 7007 Curved



Lacrimal Cannula

23 G Malleable Tip
Overall Length 25mm
AA 7010 / AAD 7010 Straight
AA 7012 / AAD 7012 Curved



Lacrimal Cannula Straight Malleable Tip

AA 7013 / AAD 7013 27 G
AA 7014 / AAD 7014 30 G



Anel

Lacrimal Cannula
Long Hub
Blunt Tip
Overall Length 14mm
AA 7015 / AAD 7015 23 G, Straight
AA 7016 / AAD 7016 25 G, Straight
AA 7017 / AAD 7017 23 G, Curved
AA 7018 / AAD 7018 25 G, Curved



Bailey

Lacrimal Cannula
7mm Exposed Blunt Tip
8mm Reinforced Shaft
Overall Length 15mm
20 G
AA 7020 / AAD 7020



Tulevech

Lacrimal Cannula
Overall Length 30mm
23 G
AA 7025 / AAD 7025



Shahinian

Lacrimal Cannula
0.3mm Side Opening
Blunt Tapered Tip
Overall Length 11mm
23 G
AA 7030 / AAD 7030



Fasanella

Lacrimal Cannula
160° Curved Tip
Overall Length 15mm
23 G
AA 7035 / AAD 7035



West

Lacrimal Cannula
Blunt Tip With Side Port
Overall Length 30mm
AA 7040 / AAD 7040 23 G



Reinforced

Lacrimal Cannula
20 G Cannula With 20mm Shaft
23 G Exposed 12mm Tip
Malleable
Overall Length 32mm
AA 7045 / AAD 7045 Straight
AA 7047 / AAD 7047 Curved



Rosenwasser

DALK Cannula
Flattened "Cobra-Shaped" Tip 0.2mm
Posterior Port
AA 7050 / AAD 7050 27 G



Mc Intyre

Anterior Chamber Cannula
Smooth Blunt Tip
45° Angled
12mm Angle Tip
Overall Length 17mm
AA 7113 / AAD 7113 23 G, Angled
AA 7114 / AAD 7114 26 G, Angled
AA 7115 / AAD 7115 30 G, Angled

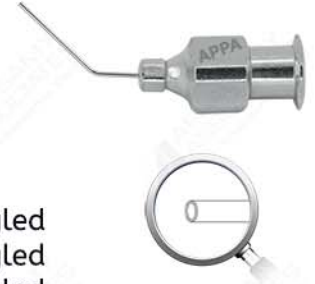

DALK

Air Injection Cannula
Flattened, 27 G Vaulted 0.2mm
Posterior Port Near Tip
AA 7100 / AAD 7100 27 G

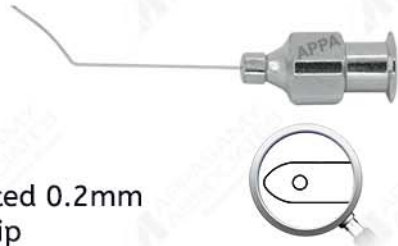

DMEK Cannula

This Device is Used to Inject Air.
Using Bend to Tip Portion, it is
Easy to Sweep Across the Interior
Segment Surface to Open the Graft.
AA 7116 / AAD 7116 23 G, Angled



Rycroft

Air Injection Cannula
45° Angled
5mm Angled Tip
Overall Length 22mm
AA 7105 / AAD 7105 16 G
AA 7105 / AAD 7105 18 G
AA 7105 / AAD 7105 19 G
AA 7105 / AAD 7105 20 G
AA 7105 / AAD 7105 21 G
AA 7105 / AAD 7105 22 G
AA 7105 / AAD 7105 23 G
AA 7105 / AAD 7105 24 G
AA 7105 / AAD 7105 25 G
AA 7106 / AAD 7106 26 G
AA 7107 / AAD 7107 27 G
AA 7108 / AAD 7108 30 G



Anterior chamber

Cannula
Curved 90° Flattened Tip
Overall Length 22mm, 27 G
AA 7120 / AAD 7120

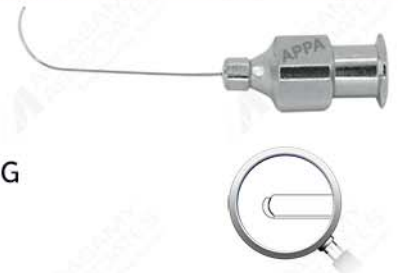

Mc Intyre

Anterior Chamber Cannula
Smooth Blunt Tip
Overall Length 17mm
AA 7110 / AAD 7110 23 G, Straight
AA 7111 / AAD 7111 26 G, Straight
AA 7112 / AAD 7112 30 G, Straight



Bracken

Anterior Chamber Cannula
Flattened Beveled Tip
Overall Length 21mm
AA 7125 / AAD 7125 16 G
AA 7125 / AAD 7125 19 G
AA 7125 / AAD 7125 20 G
AA 7125 / AAD 7125 21 G
AA 7125 / AAD 7125 22 G
AA 7125 / AAD 7125 23 G
AA 7125 / AAD 7125 24 G
AA 7125 / AAD 7125 25 G
AA 7125 / AAD 7125 26 G
AA 7125 / AAD 7125 27 G
AA 7125 / AAD 7125 30 G



Knolle

Anterior Chamber
Irrigating Cannula
2mm Angled Tip
45° Angled Tip
Front Opening
Overall Length 19mm
AA 7130 / AAD 7130 23 G
AA 7132 / AAD 7132 25 G
AA 7134 / AAD 7134 30 G



Lewicky A/C Maintainer

Anterior Chamber Maintainer Cannula
20 G x 3.50mm Cannula
Overall Length 12mm
Slightly Roughened for Self Retaining
Cannula is Connected With
200mm Long Silicone Tubing and Adaptor
AA 7150 / AAD 7150

Bishop-Harmon

Anterior Chamber
Cannula
7mm Flat Blunt Tip
40° Angled
Overall Length 25mm
AA 7135 / AAD 7135 19 G
AA 7136 / AAD 7136 20 G
AA 7137 / AAD 7137 21 G

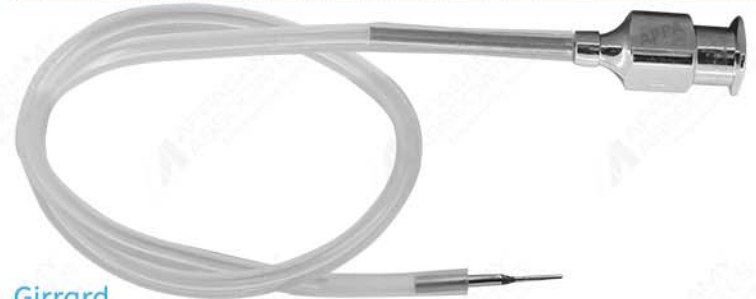

Girard

Anterior Chamber Maintainer Cannula
23 G x 5.00mm Reinforced
Cannula Atkinson Tip, Slightly
Roughened for Self Retaining
Cannula is Connected With 200mm
Long Silicone Tubing and Adaptor
AA 7155 / AAD 7155

Shepard

R.K Cannula
5mm Angled Tip
Flat Blunt Tip 45° Angled
AA 7140 / AAD 7140 27 G
AA 7142 / AAD 7142 30 G

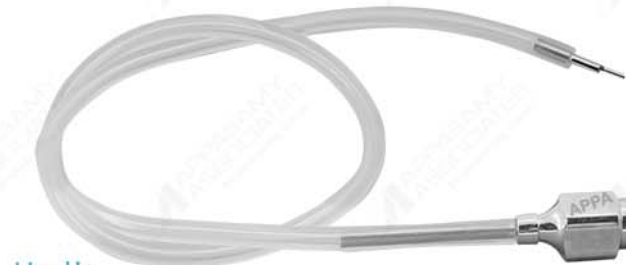

Heslin

Infusion Cannula
23 G x 3.00mm Cannula
Beveled Tip, Lightly Roughened for
Self Retaining
Cannula is Connected With 200mm
Long Silicone Tubing and Adaptor
AA 7160 / AAD 7160

Anterior Chamber

Washout Cannula
5mm Angled Tip
16 Gauge
Flat Blunt Tip
30° Angled
Overall Length 35mm
AA 7145 / AAD 7145



Brierley

Chamber Maintainer
With Positive Grip Tip
20G Self Retaining Fit
AA 7170 / AAD 7170



Chu

Hydro-Dissection Cannula
AA 7204 / AAD 7204 25 G

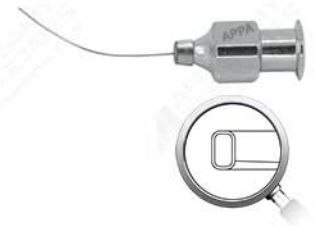

Blumenthal

Anterior Chamber
Maintainer Cannula
Smooth Oval Tip
AA 7180 / AAD 7180 20G
AA 7190 / AAD 7190 21G



Pearce

Hydrodissection Cannula
35° Angled
8mm Flat Blunt Tip
Overall Length 22mm
AA 7205 / AAD 7205 16 G
AA 7205 / AAD 7205 18 G
AA 7205 / AAD 7205 20 G
AA 7205 / AAD 7205 21 G
AA 7205 / AAD 7205 22 G
AA 7205 / AAD 7205 23 G
AA 7205 / AAD 7205 24 G
AA 7205 / AAD 7205 25 G
AA 7206 / AAD 7206 26 G
AA 7207 / AAD 7207 27 G
AA 7208 / AAD 7208 30 G



Blumenthal

Cannula
Tapered Hydrodissection/
Hydrodelineation
(Angled) 0.50x22mm(25gx7/8 in)
AA 7200 / AAD 7200



Rainin

Air Injection Cannula
Spatulated Blunt Tip
Angled at 7mm
45° Angled
Overall Length 32mm
AA 7210 / AAD 7210 27 G
AA 7212 / AAD 7212 30 G



Blumenthal

Cannula
Irrigating Cystotome (Formed)
0.40x16mm (27gx5/8 in)
AA 7201 / AAD 7201 5mm Angled



Gimbel

'U' shaped Hydrodissector
Spatulated 'U' Shaped Blunt Tip
Overall Length 22mm
AA 7215 / AAD 7215 25 G
AA 7216 / AAD 7216 27 G
AA 7217 / AAD 7217 30 G



IOL Glide

35mm Length x 5mm Wide
AA 7202 / AAD 7202 Silicone
AA 7203 / AAD 7203 Teflon



Feaster Cannula

'Hydrodissection Cannula
Wedge Shaped Tip
Dual Side Port

AA 7218 / AAD 7218 25 G Curved



Feaster Cannula

Hydrodissection Cannula
Wedge Shaped Tip
Dual Side Port

AA 7219 / AAD 7219
25 Gauge Angled



Nucleus Hydrolysis Needle

Flattened Curved Tip
Overall Length 22mm
25 Gauge

AA 7220 / AAD 7220

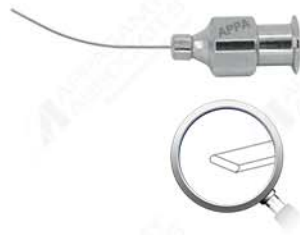

Slade Femtosecond Cannula

23 G
Overall Length: 24mm
Helps to release the Gas Bubble
Trapped Beneath the Nucleus During
Emulsification. Creates a More
Efficient Hydrodissection for the
Femtosecond Laser Procedure.

AA 7222 / AAD 7222



Nishi

Irrigating Capsule Retractor
Flattened Tip
Angled at 7mm

Overall Length 10mm
18 G

AA 7225 / AAD 7225



Kellan

Hydrodelineation Cannula
Curved Bevel Tip
Sharp On Top
Smooth On Bottom

AA 7230 / AAD 7230 18 G
AA 7230 / AAD 7230 22 G
AA 7230 / AAD 7230 23 G
AA 7230 / AAD 7230 24 G
AA 7230 / AAD 7230 25 G
AA 7230 / AAD 7230 26 G
AA 7230 / AAD 7230 27 G



Sub Tenon

Anesthesia Cannula
0.3mm Ports Blunt Tip
Overall Length 22mm

AA 7240 / AAD 7240 19 G-Dual Port
AA 7241 / AAD 7241 19 G-Triport
AA 7242 / AAD 7242 21 G-Dual Port
AA 7243 / AAD 7243 21 G-Triport
AA 7244 / AAD 7244 23 G-Dual Port

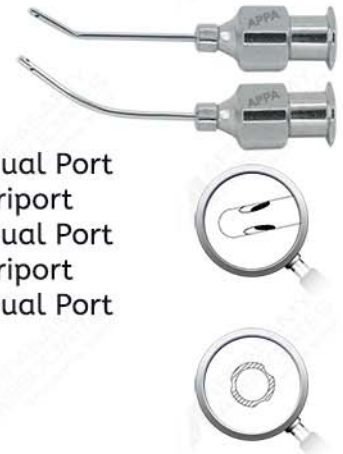

Arbisser

Anterior Chamber Cannula
Angled at 7mm

AA 7245 / AAD 7245 25 G



West

Irrigating Cannula
0.3mm Side Port
Blunt Tip
Overall Length 32mm
23 G

AA 7250 / AAD 7250



Bimanual

Irrigating Cannula
AA 7251 / AAD 7251 21 G



Binkhorst

Irrigating Cannula
2.5mm Curved Hook
30° Angled
13mm Angled Tip
Overall Length 35mm
AA 7255 / AAD 7255 22 G Straight
AA 7257 / AAD 7257 22 G Left
AA 7259 / AAD 7259 22 G Right



Wilbrandt-Binkhorst

Irrigating Cannula
2mm Curved Hook Front Opening
Blunt Tip 30 ° Angled at 8mm
Overall Length 15mm

AA 7260 / AAD 7260 23 G Straight
AA 7262 / AAD 7262 23 G Left
AA 7264 / AAD 7264 23 G Right



Mc Intyre

Cystotome Angled at 10mm
Front Opening Tip
Upward Curved Tip
23 Gauge

AA 7280 / AAD 7280



Mc Intyre-Binkhorst

Irrigating Cannula
2mm Curved Hook
Front Opening Blunt Tip
30 Degree Angled
Angled at 13mm
Overall Length 20mm

AA 7265 / AAD 7265 Straight
AA 7267 / AAD 7267 Left
AA 7269 / AAD 7269 Right



Sautter

Hydrodissection Cannula
27 G / 0.40mm

AA 7285 / AAD 7285



Sautter

Hydrodissection Cannula
26 G / 0.40mm

AA 7290 / AAD 7290



Thurmond

Nucleus Irrigating Cannula
and Iris Retractor
45 ° Angled
1mm Downward Curved Tip
Angled at 7mm, 19 G
Overall Length 27mm

AA 7270 / AAD 7270



Akahoshi

Hydrodissection Cannula
Tapered Tip Design Can Be
Easily Inserted Beneath The
Capsulorhexis Edge 27 G

AA 7295 / AAD 7295



Carter

LASIK Cannula
End Opening Flattened Tip
AA 7272 / AAD 7272 24 G



Chang

Cannula
For Injection of Heavy Liquids
(PFCL) Tapered Tube 25 G /
0.50mm Central Port for Injection
0.40mm Outer Shaft 20 G /
0.90mm with 0.50mm Lateral
Ports for Drainage

AA 7300 / AAD 7300



Salz

Irrigating Capsule Retractor
Front Opening
Downward Curved Hook
Overall Length 10mm
20 G

AA 7275 / AAD 7275



Gills

Aspirating Cannula

45° Angled

Front Opening, Blunt Tip

Overall Length 20mm 25 G

AA 7305 / AAD 7305 Angled at 5mm

AA 7306 / AAD 7306 Angled at 7mm

AA 7307 / AAD 7307 Angled at 8mm

AA 7308 / AAD 7308 Angled at 10mm



PH Jacobi

Trabecular Aspirating Cannula

AA 7316 / AAD 7316



Visco Elastic

Injection Cannula

Angled 10mm From Tip

Over All Length 25mm

AA 7309 / AAD 7309 19 G



Aspirating Cannula

Delicate

19 G / 1.10mm

AA 7317 / AAD 7317



Healon

Vitreous Aspiration Cannula

45° Angled

10mm Angled at Tip

Flattened Rounded Tip

Overall Length 32mm

AA 7310 / AAD 7310 19 G Angled

AA 7311 / AAD 7311 20 G Angled

AA 7312 / AAD 7312 21 G Angled



Aspirating Cannula

17 Gauge/ 1.50mm

AA 7318 / AAD 7318



Maumenee

Vitreous Aspirating Cannula

Straight Blunt Tip, Front Opening

Marking at 5mm, 10mm and 15mm

Overall Length 25mm

AA 7314 / AAD 7314 18 G



Gimbel

Cortex Aspirating Cannula

2mm Angled From Tip to First Bend

10mm Angled From First Bend

to Second Bend

Blunt Tip

Overall Length 17mm

30 G

AA 7320 / AAD 7320



Salz

Aspirating Cannula

Straight Blunt Tip

Overall Length 15mm

23 G

AA 7315 / AAD 7315



Morrison

Aspirating Cannula

7mm Angled Tip

Blunt Tip

Overall Length 25mm

23 G

AA 7325 / AAD 7325



Simcoe

Cortex Extractor Cannula

Light Curved Shaft

Closed Tip With 0.3mm

Side Opening

AA 7330 / AAD 7330 23 G 13mm

AA 7332 / AAD 7332 23 G 21mm

AA 7332 / AAD 7332 25 G 25mm



Anis Cortex

Cortex Aspirating Cannula
Closed Tip With 0.4mm
Side Port Finely Sand
Blasted Tip 23 G
AA 7335 / AAD 7335 Straight
AA 7337 / AAD 7337 Angled

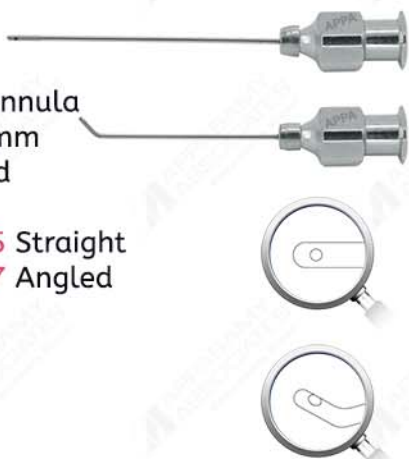

Healon Cannula

21 Gauge 45° Angled
8mm Angle From Tip
Overall Length 30mm
AA 7360 / AAD 7360



Simcoe - Welsh

Cortex Extractor Cannula
45° Angled
10mm Angled Tip
Closed Tip With 0.3mm
Aspiration Port
Overall Length 20mm 23 G
AA 7340 / AAD 7340



Weber

Aspirating Cannulas
For Viscous Fluid
Inside : 22 Gauge / 0.7mm
Outside : 20 Gauge / 0.9mm
5.0mm / 10.0mm
AA 7365 / AAD 7365



Troutman

Alpha-Chymotrypsin Cannula
Curved Shaft
Smooth Bulbous Tip
Length 26mm, 25 G
AA 7345 / AAD 7345



Weber

Aspirating Cannulas
For Viscous Fluid
Inside : 20 Gauge / 0.9 mm
Outside : 18 Gauge / 1.2 mm
5.0 mm/ 10.0mm
AA 7366 / AAD 7366



GillsWelsh

Olive Tip Cannula
45° Angled
10mm Angled Tip
Smooth Bulbous Tip
Overall Length 26mm 25 G
AA 7350 / AAD 7350

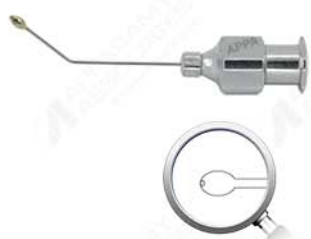

Micro

'U' Shaped Aspirating Cannula
2mm Curved Flat Tip
Overall Length 22mm
AA 7370 / AAD 7370 21 G
AA 7372 / AAD 7372 23 G
AA 7374 / AAD 7374 25 G



Welsh

Cortex Extractor Cannula
45° Angled
8mm Angled Tip
Flat Olive Tip
Overall Length 23mm
25 G
AA 7355 / AAD 7355 Straight
AA 7357 / AAD 7357 Left
AA 7359 / AAD 7359 Right



Mc Intyre

Coaxial Irrigating- Aspirating System
Includes: 1 Each AA 7405, AA 7407,
AA 7408 and AA 7409
AA 7400 / AAD 7400 Complete
Inner Cannula 23 Gauge
AA 7405 / AAD 7405 0.2mm Side Port
AA 7407 / AAD 7407 0.2mm Side Port
Truncated Outer Cannula
19 G, Side Ports
AA 7408 / AAD 7408
Nylon Connector
AA 7409 / AAD 7409



Appasamy

Aspirating Handle

AA 7410 / AAD 7410 Aspiration



Appasamy

Irrigating Handle

AA 7411 / AAD 7411 Irrigation



Simcoe

Irrigating / Aspirating Cannula
Original Model (Direct)

Aspiration Through Silicone Tube &
Irrigating Through Main Hub

Curved Shaft Overall Length 16mm

AA 7418 / AAD 7418 21 G 0.5mm Aspiration Port

AA 7418A / AAD 7418A 20 G 0.5mm Aspiration Port

AA 7419 / AAD 7419 22 G 0.35mm Aspiration Port

AA 7420 / AAD 7420 23 G 0.30mm Aspiration Port



Reverse Simcoe

Irrigating / Aspirating Cannula

Irrigation Through the Silicone
Tube and Aspiration Through
The Main Hub

AA 7423 / AAD 7423 21 G 0.50mm Aspiration Port

AA 7424 / AAD 7424 22 G 0.35mm Aspiration Port

AA 7425 / AAD 7425 23 G 0.30mm Aspiration Port



Simcoe

Irrigating / Aspirating Cannula

Sand Blasted, Original Model (Direct)
But Tips are Sand Blasted

for Polishing Posterior Capsule

AA 7430 / AAD 7430 22 G 0.35mm Aspiration Port

AA 7430 / AAD 7430 23 G 0.30mm Aspiration Port



Simcoe

Irrigating / Aspirating Cannula
Sand Blasted, Reverse Model
But Tips are Sand Blasted
For Polishing Posterior Capsule

AA 7434 / AAD 7434

22G 0.35mm Aspiration Port

AA 7435 / AAD 7435

23G 0.30mm Aspiration Port

AA 7435A / AAD 7435A

21G 0.50mm Aspiration Port



Swiss

Irrigating /Aspirating Cannula
Aspiration Through Silicone Tubing
Irrigation Through Main Hub
0.3mm Port on Left Side of
Aspirating Tube Curved Irrigating Tip
23 G Overall Length 16mm

AA 7440 / AAD 7440

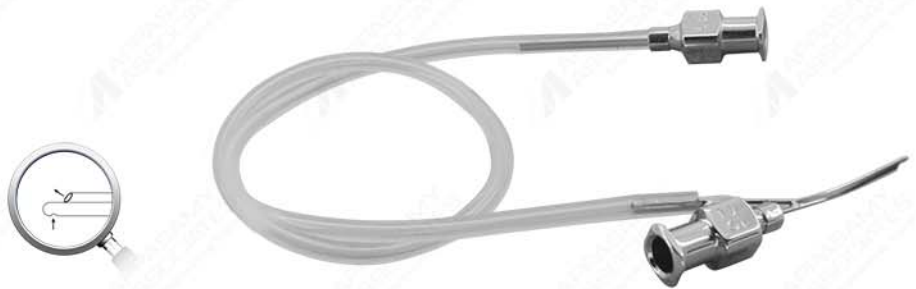

Gills

Irrigating /Aspirating Cannula
30° Angled
8mm Angled Tip
Irrigation Through Main Hub
Aspiration Through Silicone Tubing
Both Tips are Open
23 G

AA 7445 / AAD 7445



Ruit

Irrigating / Aspirating Cannula
Original Model With Serrated
Aspiration Through Silicone Tube &
Irrigation Through Main Hub
Curved Shaft Overall Length 16mm
0.30mm Aspiration Port.

AA 7446 / AAD 7446 21 G

AA 7447 / AAD 7447 23 G

AA 7448 / AAD 7448 22 G



Morrison

Irrigating / Aspirating Cannula
45° Angled
7mm Angled Tip
Aspiration Through 23 G
Main Hub, Front Opening
Irrigating Through 25 G
Thinwall and Adaptor with Silicone
Tubing Irrigating Tube with
0.3mm Side Opening
Recessed 1.5mm From Tip Supplied
Overall Length 17mm

AA 7450 / AAD 7450



Morrison

Irrigating / Aspirating Cannula
45° Angled
7mm Angled Tip
Aspiration Through 22 G
Main Hub, Front Opening
Irrigating Through 24 G
Thinwall and Adaptor with Silicone
Tubing Irrigating Tube with
0.3mm Side Opening
Recessed 1.5mm From Tip Supplied
Overall Length 17mm

AA 7452 / AAD 7452



Gills-Welsh

Irrigating / Aspirating Cannula
 20° Angled Shaft
 10mm Angled Tip
 Aspiration Through Main Hub 25 G
 Aspiration Tip 3mm Long With Olive Tip
 Irrigation Through Silicone Tubing
 Overall Length 24mm
AA 7455 / AAD 7455 Straight
AA 7456 / AAD 7456 Left
AA 7457 / AAD 7457 Right



Jensen - Thomas

Irrigating / Aspirating Cannula
 With 0.3mm Side Openings
 23 G Supplied With Silicone
 Tubing and Adaptor
AA 7460 / AAD 7460



Grandon

Irrigating / Aspirating Cannula
 Gently Curved 0.3mm Aspirating Port Facing
 Into Curve.
 Irrigating Tip With 0.3mm Side Port
 is Recessed 2.5mm
 23 G x 27mm Supplied With
 Silicone Tubing and Adaptor
AA 7465 / AAD 7465

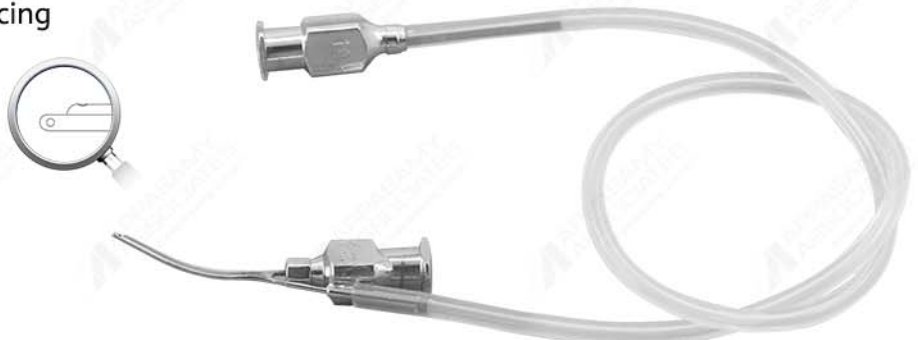

AA - Stainless Steel, AAT - Titanium, AAD - Disposable Instruments

Grandon

Irrigating /Aspirating Cannula
Slightly Curved Shaft
0.3mm Aspirating Port Facing
Into Curve.
0.3mm Irrigating Tip is Recessed 2.5mm
23 G Thin Walls.
Supplied With Silicone Tubing and Adaptor
Overall Length 27mm
AA 7467 / AAD 7467 Left
AA 7469 / AAD 7469 Right



Gess

Irrigating /Aspirating Cannula
For Aspiration Through Silicone Tubing
and Irrigating Through Main Hub
'J' Shaped Front Opening
Tip for Aspiration
Between 11 and 1 O' clock
Supplied With Silicone Tubing
and Adaptor
23 G
AA 7470 / AAD 7470 Left for 1 O' Clock
AA 7471 / AAD 7471 Right for 11 O' Clock

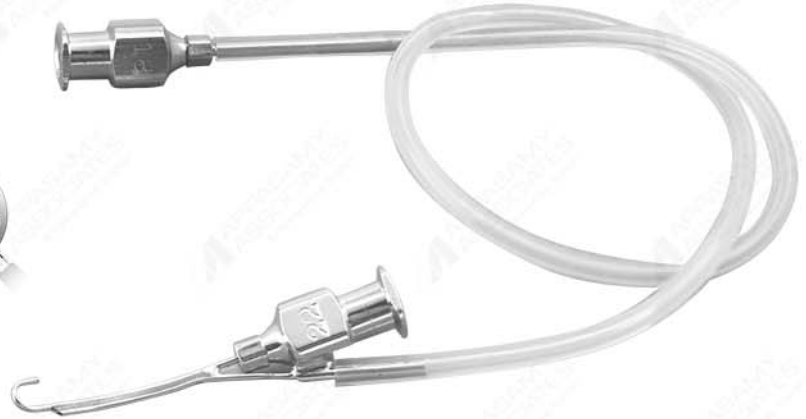

'J' Shaped I/A Cannula

Irrigating / Aspirating Cannula
Aspiration Through Silicone Tube and
Irrigation Through Main Hub
0.3mm Aspiration Port
AA 7480 / AAD 7480 Left



'J' Shaped I/A Cannula

Irrigating /Aspirating Cannula
Irrigation Through Silicone Tube &
Aspiration Through Main Hub
0.3mm Aspiration Port
AA 7482 / AAD 7482 Right



Burk
Irrigating
Trabeculotomy Cannula
AA 7485 / AAD 7485 Right



Roider
Aspirating Cannula
For Viscous Fluid
Lateral Aspiration Port 0.7mm
19 G / 1.0mm
AA 7491 / AAD 7491



Burk
Irrigating
Trabeculotomy Cannula
AA 7486 / AAD 7486 Left



Enzyme Cannula
24 G / 0.60mm
AA 7495 / AAD 7495

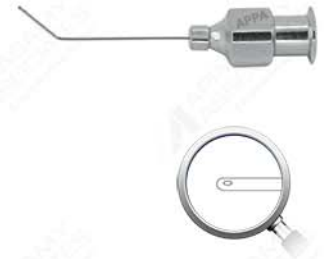

Bartz-Schmidt
Cannula for Retinal Detachment
20 G / 0.9mm
2 Lateral Ports 0.5mm
90° Transposed
Tapered Tube 19mm
25 G / 0.5mm
With Probe Tip 0.9mm
Aspirating Port 0.15mm
AA 7490 / AAD 7490



Irrigating Cannula
For Visco Canalostomy
25 G / 0.49mm
7.0 mm Angled
Tapered Tube 5.0 mm
Curved 0.19 mm
AA 7500 / AAD 7500



Atkinson Peribulbar Needle
AA 7502 / AAD 7502



Atkinson

Retroubulbar Needle
Beveled Sharp Rounded Point
Length 38mm
AA 7505 / AAD 7505 23 G
AA 7507 / AAD 7507 25 G



Bevel

Short Needle
Length 12mm
AA 7520 / AAD 7520 26 G
AA 7522 / AAD 7522 27 G
AA 7524 / AAD 7524 30 G



Appasamy

Needle 30 G for Aspirating
Intra-Vitreous fluid
AA 7510 / AAD 7510 25mm
AA 7512 / AAD 7512 12mm



Bevel

Long Needle
Length 19mm
AA 7525 / AAD 7525 26 G
AA 7526 / AAD 7526 27 G
AA 7527 / AAD 7527 30 G



Burk

Peribulbar Needle
Beveled Rounded Point
Overall Length 22mm
AA 7515 / AAD 7515 23 G
AA 7516 / AAD 7516 25 G
AA 7517 / AAD 7517 27 G



Irrigating Cystotome

Formed Straight
AA 7530 / AAD 7530 25 G
AA 7531 / AAD 7531 27 G
AA 7532 / AAD 7532 30 G



Silicone Oil Removal Cannula

AA 7518 / AAD 7518 19 G



Cystotome

Irrigating Cystotome
Formed, Angled
AA 7535 / AAD 7535 25 G
AA 7536 / AAD 7536 27 G
AA 7537 / AAD 7537 26 G
AA 7540 / AAD 7540 30 G



High Viscosity Injector Cannula

AA 7519 / AAD 7519



Kelman

Cystotome
Sharp Tip
22 G Shaft
Overall Length 32mm
AA 7550 / AAD 7550



Knolle - Kelman

Cystotome
Sharp Tip
22 G Shaft
Overall Length 32mm
AA 7555 / AAD 7555



Double Edge

Cystotome Sharp
AA 7580 / AAD 7580



Kelman

Cystotome
Blunt Tip
22 G Shaft
Overall Length 32mm
AA 7560 / AAD 7560



Double Edge

Cystotome Sharp
Double Side Sharp Cutting Edges
22 G Shaft
Overall Length 23mm
AA 7585 / AAD 7585



Kratz

Cystotome Angled
60° Angled
Angled 12mm From Tip
Sharp Tip
22 G Shaft
Overall Length 13mm
AA 7565 / AAD 7565



Blunt

Irrigating Cystotome Formed
22 G Shaft
Tip Bend Towards Bevel
Overall Length 22mm
AA 7590 / AAD 7590



Mc Intyre

Cystotome Sharp
45° Angled
Sharp Tip
22 G Shaft
Overall Length 14mm
AA 7570 / AAD 7570



Capsulorhexis Cystotome

AA 7595 / AAD 7595 Straight
AA 7597 / AAD 7597 Angled



Kelman

Double Blade Cystotome
Sharp Tip
22 G Shaft
Overall Length 32mm
AA 7575 / AAD 7575



Jensen

Capsule Polisher
Sand Blasted Olive Tip
Curved Shaft
Overall Length 28mm
AA 7605 / AAD 7605 23 G
AA 7606 / AAD 7606 25 G



Khokkar

Capsule Staining Cannula, 23G
AA 7607 / AAD 7607



Drews

Posterior Capsule Polisher
2.5mm Diameter Angled Ring
Port on in Side at 6 'O' Clock
Sand Blasted Posterior Surface
25 G
AA 7625 / AAD 7625



Akahoshi

Visco Cannula
With an Oval Port
at Its External Tip
For Perfect Staining
of the Capsule 27G
AA 7608 / AAD 7608 Curved



Graether

Collar Button Polisher
Iris Retractor With Sand Blasted
Posterior Surface 23 G
Overall Length 25mm
AA 7630 / AAD 7630 Straight
AA 7632 / AAD 7632 Angled

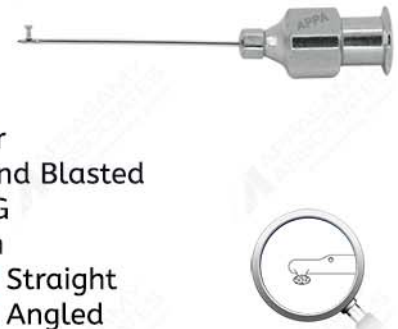

Knolle

Capsule Polisher
45° Angled
2mm Angled From Tip
Front Opening and Sand Blasted
Overall Length 13mm
AA 7610 / AAD 7610 23 G
AA 7615 / AAD 7615 30 G



Kratz

Posterior Capsule Scratcher
1mm Angled Sand Blasted Tip
Overall Length 12mm
AA 7635 / AAD 7635 23 G
AA 7636 / AAD 7636 25 G



Kraff

Posterior Capsule
Polishing Curette
25 G Shaft
1.75mm Diameter Cup
With Semi Sharp
Irrigating Port in Centre of Cup
AA 7620 / AAD 7620 25 G



Henderson

MICS Capsule Polishing Cannula
Finely Textured, 1.2mm Wide
Disc-Shaped Tip, With 0.5mm Posterior
Facing Port, 23 G
AA 7621 / AAD 7621



Rubman - katzin

Posterior Capsule Polisher
0.3mm Inside Facing Port
3mm Angled Sand Blasted
Blunt Tip 22 G
AA 7640 / AAD 7640



Shapiro

Posterior Capsule Polisher
0.3mm Side Port With Closed Tip
Curved 23 G Shaft
Sand Blasted Tip
Overall Length 18mm
AA 7645 / AAD 7645



Simcoe

Posterior Capsule Polisher
0.3mm Side Port Sand Blasted Tip
Curved Shaft
Overall Length 13mm
23 G
AA 7655 / AAD 7655

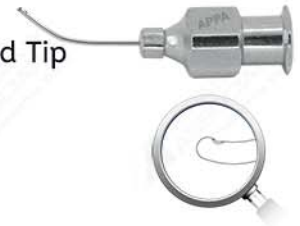

Simcoe

Anterior Capsule Scrubber
45° Angled
23 G Shaft
Sand Blasted Tip
Overall Length 19mm
AA 7650 / AAD 7650



Simcoe

Cortex Extractor
0.3mm Side Port Sand Closed
Sand Blasted Tip
Curved Shaft 23 G
AA 7660 / AAD 7660 13mm
AA 7665 / AAD 7665 21mm



Simcoe

Posterior Capsule Scrubber
45° Angled
23 G Shaft
Overall Length 19mm
AA 7652 / AAD 7652



Chang

Hydrodissection Cannula
Flat Beveled Tip 90° Angled
27 G
AA 7666 / AAD 7666



Lahane

Capsulorhexis and
Posterior Capsule
Polisher, Irrigating
Vacuum Action Left Hand
Aspirating Angled Shaft
23 G With 0.3mm
Reverse Aperture
AA 7653 / AAD 7653



Freeman

Posterior Capsule Polisher
12mm Flattened Angled Tip
4mm Sand Blasted Tip
With Irrigating Holes
on Tip and Sides
Overall Length 32mm
19 G
AA 7670 / AAD 7670



Akahoshi Ring Levitator

To lift Dropping Nucleus From Pars Plana the Viscoelastic Material Can Help in Levitation . Loop Can Be Introduced Through 2.5mm Incision

AA 7675 / AAD 7675



Drews

Irrigating Vectis
6mm Wide, 9mm Long Loop
One Forward and Two Reversed Irrigating Ports
Overall Length 35mm

AA 7710 / AAD 7710



Alfonso-McIntyre

Irrigating Nucleus Spoon
Single 0.3mm Front Open Port For Extracting Nucleus Fragments During Manual Small Incision Surgery

AA 7680 / AAD 7680 2.5mm Wide

AA 7681 / AAD 7681 4.0mm Wide



Sheets

Irrigating Vectis
6mm Wide, 19mm Long Loop
Three Irrigating Ports at 12, 10 & 2 O' clock Positions
Serration on Top of Vectis
21 G

AA 7715 / AAD 7715



Zirm

Lasik Dissector Cannula
25 G/0.5 mm

AA 7685 / AAD 7685



Anis

Irrigating Vectis
5mm Wide, 7mm Long Loop
Two Irrigating Ports
Overall Length 36mm

AA 7720 / AAD 7720 23 G



Zirm

Lasik Irrigating Cannula
20 G/0.9 mm

AA 7690 / AAD 7690



Simcoe

Nucleus Delivery Cannula
34mm Wide, 15mm Long Loop
Two Irrigating Ports
Serration on Loop, 25 G

AA 7725 / AAD 7725 Left



Knolle-Pearce

Irrigating Vectis
Ports on Outer Side
Overall Length 38mm

AA 7705 / AAD 7705 20 G

AA 7705 / AAD 7705 21 G

AA 7705 / AAD 7705 23 G

(4mm Wide, 7mm Long Loop)

AA 7706 / AAD 7706 23 G

(5mm Wide, 6mm Long Loop)

AA 7707 / AAD 7707 23 G

(4mm Wide, 10mm Long Loop With Half Plate)



Simcoe

Nucleus Delivery Cannula
34mm Wide, 15mm Long Loop
Two Irrigating Ports
Serration on Loop, 25 G

AA 7726 / AAD 7726 Right



Nishi

Nucleus Delivery Cannula
Irrigating Cannula for Lens
Nucleus Delivery

AA 7730 / AAD 7730 Left



Youens

Lens Manipulating Cannula
45 Degree Angled
10mm Angled Flat Tip
0.3mm Diameter Tip
30 G Overall Length 15mm

AA 7755 / AAD 7755



Nishi

Nucleus Delivery Cannula
Irrigating Cannula for Lens
Nucleus Delivery

AA 7732 / AAD 7732 Right



kuglen

Irrigating Lens Manipulator
Disc Shapped Tip With 0.25mm
Diameter

Peg Protruding From Its Centre.
Overall Length 26mm 25 G

AA 7760 / AAD 7760 Straight

AA 7762 / AAD 7762 Angled

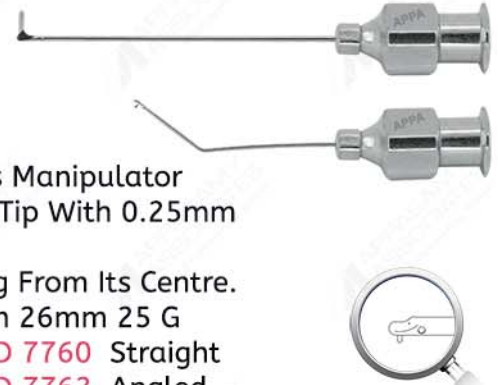

Micro

Irrigating Vectis
Lightly Angled Loop
Irrigating Port Facing
Out Side Circle

AA 7740 / AAD 7740 21 G

AA 7741 / AAD 7741 23 G



Kratz

Lens Manipulating Cannula
0.2mm Diameter Front Opening Tip
45 Degree Angled
10mm Angled Tip
Overall Length 15mm
30 G

AA 7765 / AAD 7765

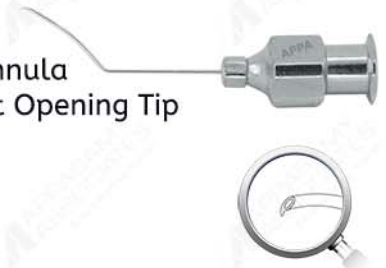

Hoffman

Nucleus Loop
4mm Wide, 14mm Long
Curved Loop
16 G Shaft
Three Irrigating Ports
Serrated Loop
Overall Length 32mm

AA 7745 / AAD 7745



Osher

Lens Manipulating Cannula
24 Gauge Shaft
30 Gauge Working Tip
0.2mm Side Port and Pigtail Tip
Overall Length 23mm

AA 7770 / AAD 7770



Small Incision nucleus

Delivery cannula
5mm Wide, 10mm Long
21G Loop,
0.5mm Single
Front Opening Port

AA 7750 / AAD 7750



Bechert

IOL Cannula
45 Degree Angled
5mm Angled Tip
Horizontal Groove on Tip
Overall Length 19mm, 27 G

AA 7775 / AAD 7775



Castroviejo

Cyclodialysis Cannula
45 Degree Angled
15mm Angled Flattened Tip
Semi-Sharp Sides
19 G
Overall Length 27mm
AA 7805 / AAD 7805



Randolph

Cyclodialysis Cannula
Curved Spatulated Tip
19 Gauge
13mm Angled Tip
Overall Length 29mm
AA 7825 / AAD 7825 19 G
AA 7827 / AAD 7827 21 G



Kelman

Cyclodialysis Cannula
45 Degree Angled
12mm Angled Flattened Tip
Side Opening, 19 Gauge
Overall Length 32mm
AA 7810 / AAD 7810 Right Opening
AA 7812 / AAD 7812 Left Opening



Silicone

Bulb With Adaptor
AA 7830 / AAD 7830
Adaptor
AA 7835 / AAD 7835



Sheets

Cyclodialysis Cannula
Flattened 12mm Tip
Irrigating Port on Both Sides
and Front Tip Opening
Overall Length 32mm
19 G
AA 7815 / AAD 7815



Simcoe

Nucleus Spatula
Dislocate Soft Nucleus
25 G x 12mm Spatula End 2mm
AA 7840 / AAD 7840

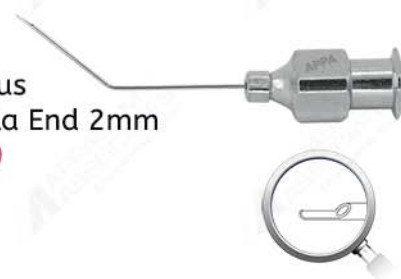

Gans

Cyclodialysis Cannula
Opening on Left Side
12mm Angled Tip
19 G
AA 7820 / AAD 7820



Gans

Cyclodialysis Cannula
Both Sides Opening
12mm Angled Tip
19 G
AA 7822 / AAD 7822



Silicone Tube

O.D 2.4, I.D 0.9
AA 7845 / AAD 7845
Tube With Adaptor
AA 7846 / AAD 7846
Tube Only



Lasik

Cannula

Overall Length 25mm

AA 7850 / AAD 7850 Straight

AA 7851 / AAD 7851 Curved



Buratto

LASIK Cannula

One Front and Two Side Ports

Designed for Equal Flow in Three Directions.

AA 7861 / AAD 7861 23 G

AA 7862 / AAD 7862 25 G



Visco Elastic

Cannula

45° Angled, 8mm

Angle From Tip

Overall Length 30mm

AA 7852 / AAD 7852

AA 7853 / AAD 7853



Kritizinger

Up Degraft

LASIK Irrigating Cannula

Overall Length 37mm

AA 7863 / AAD 7863 23 G



Vidaurri Lasik Flap Irrigator

Parallel Cannula

Each With Four Ports

Simultaneously Irrigated

Both Sides of the Lasik Flap

Angled 10mm

Overall Length 25mm

AA 7855 / AAD 7855 25 G

Overall Length 36mm

AA 7856 / AAD 7856 25 G

Overall Length 33mm

AA 7857 / AAD 7857 24 G

AA 7858 / AAD 7858 26 G

AA 7859 / AAD 7859 27 G



Kritizinger

Up Degraft

LASIK Irrigating Cannula

Overall Length 37mm

AA 7864 / AAD 7864 19 G



Nichamin

Lasik Irrigating Cannula

Flattened Tip, With 12mm,

Slightly Formed Curvature,

Open Ended for Elevating the

Corneal Flap and Irrigation

Overall Length 25mm

AA 7865 / AAD 7865 23 G

AA 7866 / AAD 7866 25 G

AA 7867 / AAD 7867 27 G



Quad Ported

Lasik Irrigating Cannula

Four Ports to Irrigate

The Surgical Interface and

Flush the Debris

Overall Length 35mm

AA 7860 / AAD 7860 23 G



Nichamin

Lasik Irrigating Cannula

Flattened Tip, With 6mm,

Slightly Formed Curvature,

Open Ended for Elevating the

Corneal Flap and Irrigation

Overall Length 25mm

AA 7870 / AAD 7870 23 G

AA 7871 / AAD 7871 25 G

AA 7872 / AAD 7872 27 G

AA 7873 / AAD 7873 24 G

AA 7874 / AAD 7874 26 G



Gimbel Lasik

Fountain Cannula
45° Angled 5mm
Overall Length 17mm
AA 7875 / AAD 7875 25 G



Lasik

Irrigating Cannula
6 Ports
2mm Wide, 4mm Long
14mm Curved Tip
Overall Length 31mm, 23 G
AA 7891 / AAD 7891



Banaji Lasik

Cannula (6 Ports)
45° Angled 10mm
Overall Length 22mm
AA 7880 / AAD 7880 25 G



20 psi Vitrectomy Cutter

For 20 psi Surgery Systems,
Autoclavable
AA 7900 20 G
AA 7901 23 G
AA 7902 25 G



Buratto Lasik

Cannula (3 Ports)
45° Angled 8mm
Overall Length 23mm
AA 7885 / AAD 7885 23 G
AA 7886 / AAD 7886 25 G



Posterior

4500 CPM, 5040 CPM
30PSi
AA 7900 P 20 G
AA 7901 P 23 G
AA 7902 P 25 G



Nichamin

Lasik Irrigating Cannula
3 Ports
45° Angled 8mm
Overall Length 28mm
23 G
AA 7887 / AAD 7887



Pressure Line Adapter

AA 7904



Spatulated

Lasik Cannula
60° Angled 10mm
Flattened Tip
Overall Length 25mm
25/26 G
AA 7890 / AAD 7890



Packo
Pars Plana Cannula
AA 7905 / AAD 7905



Subretinal Injection
Cannula Needle
AA 7912 / AAD 7912
Straight



Packo
Back Flush Needle
AA 7909 / AAD 7909
20 G, Blunt
AA 7910 / AAD 7910
19 G, Blunt



Subretinal Injection
Cannula Needle
AA 7913 / AAD 7913 Curved



Packo
Back Flush Needle
AA 7911 / AAD 7911
20 G, Blunt



Packo
Subretinal Fluid
Drainage Needle
20 Gauge With 25 Gauge Tip
Side Opening
AA 7914 / AAD 7914



Tapered
Extrusion Hand Piece Cannula
20 Gauge 35mm,
2mm Tapered 27 Gauge Blunt
AA 7915
AA 7916 Needle Only 27 G



Charles
Flute Needle Cannula
Extrusion Hand Piece
20 Gauge, 35mm, Blunt Tip
AA 7920
AA 7921 Needle Only



AA - Stainless Steel, AAT - Titanium, AAD - Disposable Instruments



Charles Flute Cannulas

Designed to Aspirate Blood and Debris From the Posterior Segment. P Smooth, Finished Tip Provides Atraumatic Entry and Reduces Risk of Trauma to Surrounding Tissue.

AA7915 A 23G
AA 7915 B 25G

Soft Tip Cannulas

Flexible Tip Allows Atraumatic Entry Through Retinal or Macular or Holes and Enables Aspiration of Subretinal Fluid

AA 7917 20G
AA 7917 A 23G
AA 7917 B 25G

Brush Tip Cannulas

For Atraumatic Brushing of Retina.

AA 7921 A 23G
AA 7921 B 25G

Diamond Dusted Soft Tip Cannulas

Designed for Better Cohesion and Gentle Sweeping of the Membrane

AA 7922 20G
AA 7922 A 23G

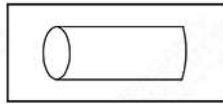

Charles Flute Cannula

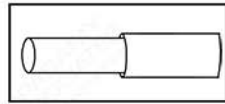

Soft Tip Cannula

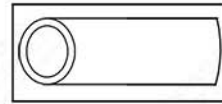

Brush Tip Cannula

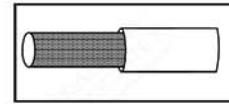

Diamond Dusted Cannula

Scleral Plug Forceps

Designed to Securely Hold Scleral Plugs During Insertion and Removal Cross Action Handle Reduces Hand Fatigue While Grasping Plug

AA 7925 / AAD 7925



Watzke

Sleeve Spreading Forcepes Serrated 10mm Tips Angled 30° Serrtted Cross Action Handle

AA 7930 / AAD 7930



TROCAR CANNULA SYSTEM

Disposable One Step Trocar System

Flat Stiletto Knife for Smooth Incision

Unique Closure Valve System

Proximal End with 3.0 mm and 4.0 mm

Scleral Marker

Each Pack Includes:

Trocar Knife With Preloaded Trocar Cannula - 4

Pre Loaded Trocar Cannula Plug - 4

Infusion Line - 1

Sterile



Trocar Cannula Plug



23 G

25 G

27 G

Trocar Cap



AAD 7939 23 G

AAD 7939 A 25 G

AAD 7939 B 27 G

AAD 7936 23G



AAD 7936 A 25G



AAD 7936 B 27G



VALVED TROCAR CANNULA SYSTEM

Valved Trocar Cannula Plug



23 G

25 G

27 G

AAD 7941 23G



AAD 7941 A 25G



AAD 7941 B 27G



ACCESSORY (CAN BE ORDERED SEPARATELY)

Trocar Loading Forceps

AA 3712



Trocar Fixation Plate

AA 7945



Trocar Infusion Cannula

Packaged Sterile

AAD 7965 23G

AAD 7966 25G

AAD 7967 27G



Scleral Plugs

- AA 7950 18 G
- AA 7951 19 G
- AA 7952 20 G



Infusion Cannula

20 Gauge, Luer Lock Adapter & 250mm of Silicone Tubing

- AA 7960 / AAD 7960 2.5mm Beveled Tip
- AA 7961 / AAD 7961 4.0mm Beveled Tip
- AA 7962 / AAD 7962 6.0mm Beveled Tip

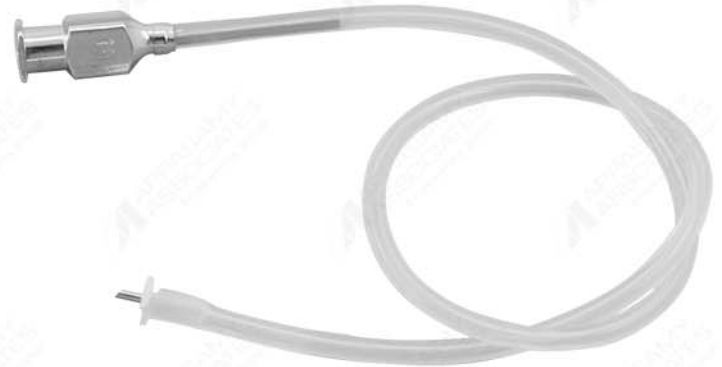

Silicone Oil Infusion Cannulas

Unique Design Facilitates the Injection of Silicone Oil and Other Viscous Fluids.

Disposable

- AA 7961A / AAD 7961A 4.0mm 20G
- AA 7962A / AAD 7962A 6.0mm 20G

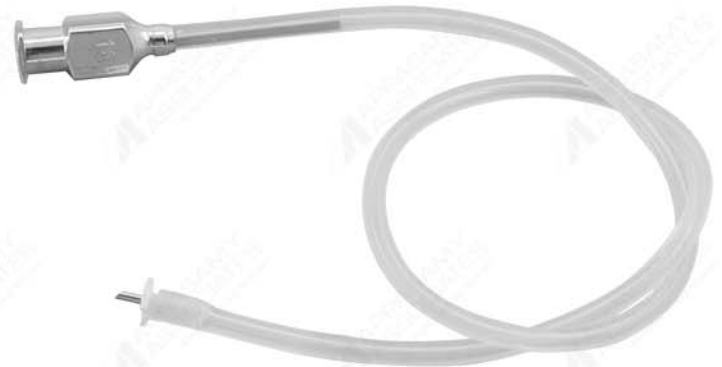

Self-Retaining Sutureless Infusion Cannulas

Sutureless Fixation. Retaining Ridge Holds Cannula in Place.

Disposable

- AA 7961B / AAD 7961B 4.0mm 20G
- AA 7961C / AAD 7961C 4.0mm 23G
- AA 7962B / AAD 7962B 6.0mm 20G
- AA 7962C / AAD 7962C 6.0mm 23G

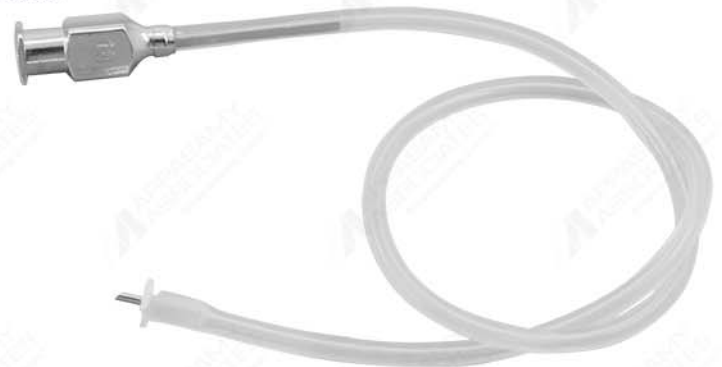

45 Diaptor

Irrigating Contact Lens
Plano-Concave Hand Held
Irrigating Vitrectomy Lens
AA 7970 / AAD 7970



90 Diaptor

Irrigating Contact Lens
Bi-Concave Hand Held
Irrigating Vitrectomy Lens
AA 7975 / AAD 7975



Vitreous Lens Handle

Aluminium
AA 7977



Backflush Handle, Reusable

Passive Aspiration
AA 7979 / AAD 7979
Active Aspiration
AA 7979A / AAD 7979A

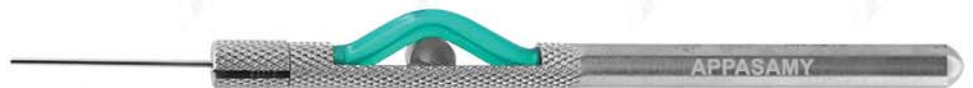

Membrane Peeler
AA 7980 / AAD 7980



Irrigating
Micro Retinal Pick
20 Gauge Needle 25mm Long
With 25 Gauge X 5mm Sharp Tip
Cutting Edges Bent to 50 Degree
AA 7993 / AAD 7993



May
30 Degree Bent Infusion Needle
AA 7985 / AAD 7985



Irrigating
Micro Retinal Pick
20 Gauge Needle With 2mm
Long Pick
AA 7994 / AAD 7994



Packo
Subretinal Fluid
Drainage Needle
20 Gauge With 25 Gauge Tip
Side Opening
AA 7990 / AAD 7990



Irrigating
Micro Retinal Pick
20 Gauge Needle With 4mm
Long Pick
AA 7995 / AAD 7995



Subretinal
Fluid Drainage Needle
Straight With Silicone Tip
AA 7991 / AAD 7991



Vitreo Retinal
Viscodissector
20 Gauge X 25mm Cannula
With 30 Gauge X 5mm Cannula
Angled 90 Degree With a
1mm Flattened Tips
AA 7996 / AAD 7996



Subretinal
Fluid Drainage Needle
Curved With Silicone Tip
AA 7992 / AAD 7992



INSUBRETINAL CANNULAS

Designed for injecting or aspirating fluid under the retina. Surface of injector tip, opposite the bevel, may be used to slightly elevate the retina as fluid is injected.



Landers Subretinal Aspirator

Angled 2.5mm

AA 4908 20 G x 1 in (.90 x 25mm)

AA 4909 27 G x 6 mm Tip



Landers Subretinal Aspirator

Curved

AA 4910 20 G x 1 in (.90 x 25mm)

AA 4911 27 G x 6 mm Tip



Glaser Subretinal Injector

Curved

AA 4912 20 G x 1 in (.90 x 25mm)

AA 4913 33 G x 3 mm Distal End



Glaser Subretinal Injector

Straight

AA 4914 20 G x 1 in (.90 x 25mm)

AA 4915 33 G x 3 mm distal end



Glaser Subretinal Cannula

Angled 1 mm

AA 4916 20 G x 1 in (.90 x 25mm)

AA 4917 33 G x 3 mm distal end



Peyman High Viscosity Fluid Cannula

AA 4918 16 G x 9 mm (3/8 in)

Vitreoretinal Cannulas

Cannula extends into hub reducing the chance of additional air bubble in the syringe from entering cannula.



Vander Vitreoretinal Cannula

Straight

AA 4919 20 G x 1 in (.90 x 25mm)

AA 4920 30 G Tip



Vander Vitreoretinal Cannula

Angled 45°

AA 4921 20 G x 1 in (.90 x 25mm)

AA 4922 30 G (.30 mm) Tip

VITREORETINAL MICROPICKS

For removing premacular, epiretinal and other vitreoretinal membranes.



Glaser Vitreoretinal Micropick

Angled 50°

AA 4923 20 G x 1 in (.90 x 25mm)

AA 4924 25 G x 3/16 in (.50 x 5mm)

0.5 mm Sharp Tip



Eaton Vitreoretinal Micropick

Angled 50°

AA 4925 20 G x 1 in (.90 x 25mm)

AA 4926 25 G x 3/16 in (.50 x 5mm)

0.5 mm Sharp Tip

RETINAL CANNULAS

Dual Bore PFC Cannula

Designed to simultaneous infusion of heavy liquids and Aspiration of intraocular fluids.

Dual bore enables to control constant intraocular pressure during Injection.

AA 4900 20G

AA 4901 23G

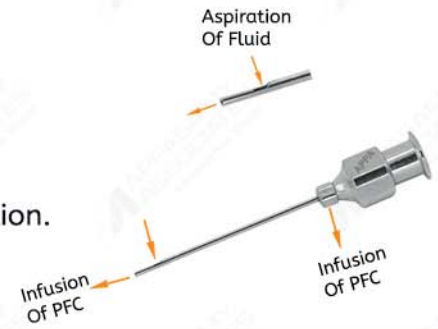

Dual Bore BSS injection Needle

0.1mm/41 G tip

Enables to control subretinal injection of BSS.

Dual bore cannula combined with aspiration capability

AA 4902 20G



Viscous fluid injection cannula

5 Per Box

Allows Injection of viscous fluids such as silicone oil Through 23G Trocar Cannula.

10mm Polyimide Tip.

AA 4903 23G



SUBRETINAL FLUID CANNULAS

Flexible sleeve allows atraumatic entry through retinal or macular tears or holes and enables aspiration of subretinal fluid.



Grizzard Subretinal fluid Cannula

Angled

AA 4927 20 G x 1 in (.90 x 25mm)

AA 4928 25 G x 5/32 in (.30 x 4mm) Tip

6mm Tubing Extension

Tubing : D - 0.3mm (0.012in), OD - 0.6mm (0.025in)



Grizzard Subretinal fluid Cannula

Straight

AA 4931 20 G x 1 in (.90 x 25mm)

AA 4932 25 G x 5/32 in (.30 x 4mm) Tip

6mm Tubing Extension

Tubing : D - 0.3mm (0.012in), OD - 0.6mm (0.025in)



Grizzard Subretinal fluid Cannula

Angled

AA 4929 20 G x 1 in (.90 x 25mm)

AA 4930 25 G x 5/32 in (.50 x 4mm) Tip

6mm Tubing Extension

Tubing : D - 0.3mm (0.012in), OD - 0.6mm (0.025in)



Grizzard Subretinal fluid Cannula

Straight

AA 4933 20 G x 1 in (.90 x 25mm)

AA 4934 25 G x 5/32 in (.50 x 4mm) Tip

6mm Tubing Extension

Tubing : D - 0.3mm (0.012in), OD - 0.6mm (0.025in)

Appasamy Sterilization Box

Suitable for Appa Blade Autoclave Small
With Hinged Lid
Size: 165 X 90 X 15mm
AA 8000 Complete



Appasamy Sterilization Box

Small With Hinged Lid
A stainless steel sterilizing box designed to protect a Set of Ultra Fine Micro Surgical Instruments During Sterilization, Storage and Transport. A Soft Autoclavable Silicone Mat Accommodates Various Small Instruments. Pegs Keep Instruments In Perfect Place. Lid and Base of Case, and Silicone Mat are Perforated With Holes are to Facilitate Rapid Drainage of Fluid After Rinsing or Steam Sterilization. Size: 165 x 90 x 15mm
AA 8003 Complete Silicone Mat



Appasamy Sterilization Box

Suitable for Appa Blade Autoclave Small
With Hinged Lid
With Silicone Mat Small
Size: 202 X 120 X 18mm
AA 8005 Complete
AA 8010 Case Only
AA 8015 Silicone Mat



Appasamy Sterilization Box

Medium With Hinged Lid
Size: 240 x 200 x 18mm
With 2 Silicone Mats
AA 8020
AA 8015 Silicone mat



Appasamy Sterilization Box

Small With Hinged Lid
Size: 205 x 125 x 30mm
With 2 Silicone Mats
AA 8030 Double Tucker
AA 8015 Silicone Mat



Appasamy See-Through Plastic Sterilization Box

This box is made of a special thermoplastic which is designed to withstand repeated autoclaving cycles. The box can be used for steam sterilization and ETO sterilization methods. The soft silicone mat protect the instruments during sterilization transport and storage. Lid and base of box and silicone mat are perforated with round holes for steam penetration and subsequent drainage. The transparent lid helps visualization during closure of the box the instruments do not touch each other and also to make sure that the lid is not applying any pressure on to the tips of the instruments.

Appasamy Sterilization Box With one silicone mat

Size: 245 x 146 x 25mm

AA 8200 Complete

AA 8205 Box Only

AA 8015 Silicone Mat

Size: 240 x 140 x 15mm

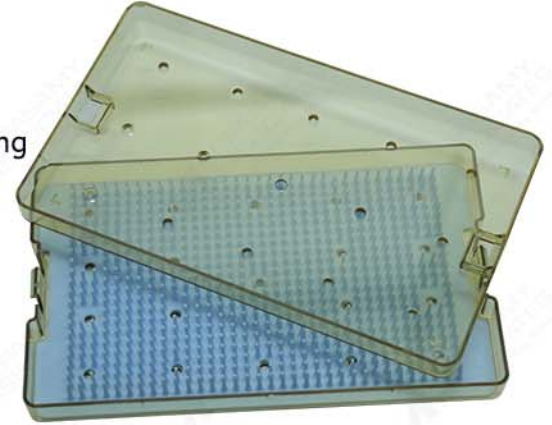

Appasamy See-Through Plastic Sterilization Box

AA 8201

Size: 198 x 108 x 20mm



Appasamy See-Through Plastic Sterilization Box

AA 8202

Size: 160 x 70 x 20mm



Appasamy See-Through Plastic Sterilization Box

AA 8203

Size: 160 x 70 x 35mm



Appasamy See-Through Plastic Sterilization Box

AA 8206

Size: 78 x 45 x 20mm

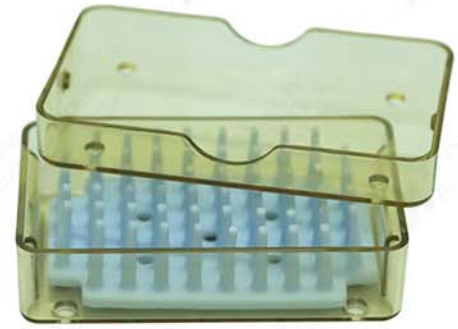

Appasamy See-Through Plastic Sterilization Box

AA 8207

Size: 78 x 45 x 35mm



Appasamy See-Through Plastic Sterilization Box

AA 8215

Size: 245 x 147 x 45mm

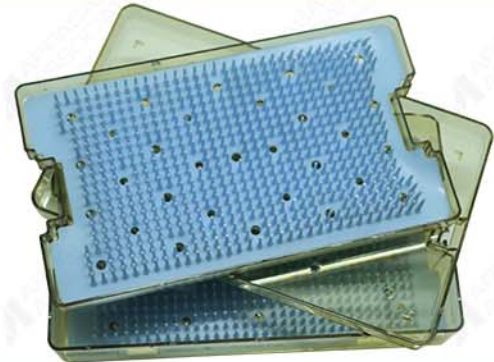

Appa Phaco Box

A Stainless Steel Sterilizing Box

Designed to Protect of Phaco Handpiece During Sterilization

Size: 230 X 155 X 60 mm

AA 8220



Appasamy See-Through Phaco Hand Piece Sterilization Box

AA 8221

Size: 245 x 147 x 45mm

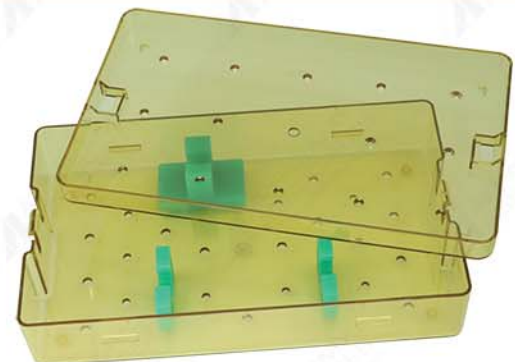

Appasamy Phaco Tray
Suitable for
Appa Phaco Machine
AA 8225



Appasamy Phaco Ring
Suitable for
Appa Phaco Tray
AA 8226



Appa-Schiotz
Tonometer
Autoclavable
Accurate Calibration
AA 9010



Super Pinkey Ball
For Intraocular
Pressure Reducer
AA 9020



Bipolar Forceps
Tenzel Bipolar Forceps
Jeweler's Type
Pointed Tip, Straight
AA 9100 / AAD 9100



Mc pherson
Straight Bipolar Forceps
AA 9110 / AAD 9110 Straight



Mc pherson
Curved Bipolar Forceps
AA 9120 / AAD 9120 Curved



Mc pherson
Angled Bipolar Forceps
AA 9130 / AAD 9130 Angled



Coaptation
Bipolar Forceps
AA 9140 / AAD 9140 Angled



AA - Stainless Steel, AAT - Titanium, AAD - Disposable Instruments

Bipolar Forceps

Straight
for DCR

AA 9145 / AAD 9145



Bipolar Cord Silicone Reusable

AA 9150 / AAD 9150



Bipolar Eraser

Autoclavable Plastic

AA 9160 / AAD 9160 15°, 18 G

AA 9161 / AAD 9161 30°, 18 G

AA 9162 / AAD 9162 45°, 18 G

AA 9165 / AAD 9165 15°, 20 G

AA 9166 / AAD 9166 30°, 20 G

AA 9167 / AAD 9167 45°, 20 G

AA 9168 / AAD 9168 0°, 23 G

AA 9169 / AAD 9169 30°, 23 G

AA 9169A / AAD 9169A 0°, 25 G

AA 9169B / AAD 9169B 30°, 25 G



Disposable Battery Cautery

Accessories and Burners for
Elemental Cautery

AAD 9180

Tip Only

AAD 9180A





Endoillumination Probe, Focus

- AA 9170 20G
- AA 9173 23G
- AA 9175 25G
- AA 9177 27G

Focus
A= 12.5
(at 10mm distance)
angle = 62°

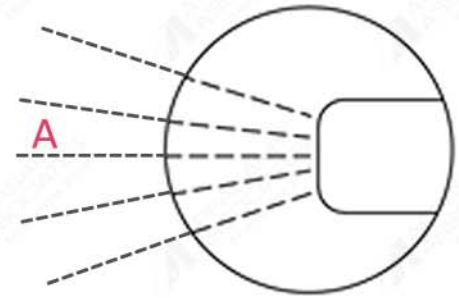

Endoillumination Probe, Wide Angle

- AA 9170A 20G
- AA 9173A 23G
- AA 9175A 25G
- AA 9177A 27G

Wide angle
A= 9mm
B=46mm
(at 10mm distance)
angle = 134°

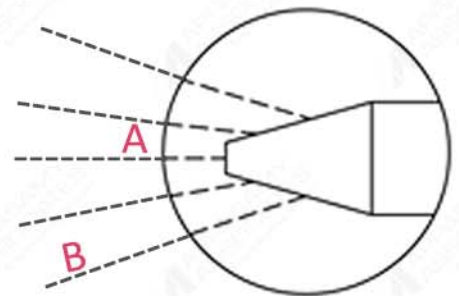

Endoillumination Probe, Shielded

- AA 9170B 20G
- AA 9173B 23G
- AA 9175B 25G
- AA 9177B 27G

Shielded
A= 9mm
B=25mm
(at 10mm distance)
angle = 102°

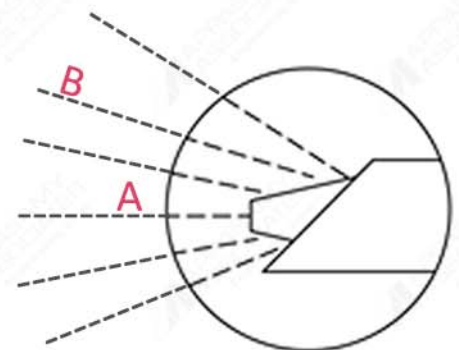

Phaco Tip

With Groove

AAT 7415 0° Tip

AAT 7415A 15° Tip

AAT 7415B 30° Tip

AAT 7415C 45° Tip



Phaco Wrench

AA 7416



Phaco Tip

Without Groove

AAT 7417 0° Tip

AAT 7417A 15° Tip

AAT 7417B 30° Tip

AAT 7417C 45° Tip



Cobra Phaco Tip

AAT 7475 0° Tip

AAT 7475A 15° Tip

AAT 7475B 30° Tip

AAT 7475C 45° Tip



Kelman Phaco Tip

AAT 7476 0° Tip

AAT 7476A 15° Tip

AAT 7476B 30° Tip

AAT 7476C 45° Tip



Phaco Tip

Without Groove for Phakonit

AAT 7477 0° Tip

AAT 7477A 15° Tip

AAT 7477B 30° Tip

AAT 7477C 45° Tip



Fragmentome

AAT 7478A 15° Tip

AAT 7478B 30° Tip



NO ANESTHESIA CATARACT SET & PHAKONIT SET

(Cataract removal through a 0.9mm incision)

No Anesthesia Cataract surgery:- No topical or intracamral anesthesia. In this surgery, the patient has no anesthetic drops put in his eye and then the cataract removed. The Cataract is removed through a small needle thin incision 2.5mm with a phaco technique. Then a foldable intraocular lens is inserted inside the through the small incision. The patient are not admitted in the hospital and after the surgery, they can resume their normal work from the next day onwards.

phakonit Surgery:- No topical or intracamral anesthesia. In this surgery, the patient has no anesthetic drops put in his eye and then the cataract removed. The Cataract is removed through a small needle thin incision 2.5mm with a phaco technique. Then a foldable intraocular lens is inserted inside the through the small incision. The patient are not admitted in the hospital and after the surgery, they can resume their normal work from the next day onwards.

Agarwal No Anesthesia
No Anesthesia
Self Retaining Eye Speculum
Solid Blades
AAT 1125



Agarwal No Anesthesia
(Usefull for small pupils)
Nucleus Rotator & Spatula
AAT 1625



Agarwal Phaco Chopper
(For Karate Chopping)
Fully Cutting Edge
AAT 1993



AA - Stainless Steel, AAT - Titanium, AAD - Disposable Instruments

Agarwal Irrigating Phaco Chopper
(For Karate Chopping)
20 G Double Port
0.5mm Irrigation Port,
1mm Cutting Edge
AAT 7390



Agarwal Irrigating 'Y' Chopper
(Useful for Small Pupils)
20G Double Port
0.5mm Irrigation Port,
AAT 7391



Aspirating Hand Piece
21G single Port
0.35mm Aspiration Port,
AAT 7410



Irrigating Hand Piece
20G Double Port
0.5mm Irrigation Port,
AAT 7411



Agarwal No Anesthesia
No Anesthesia
Self Retaining Eye Speculum
Solid Blades
AAT 1125



APPASAMY Introduces new instruments for bimanual irrigation and aspiration of residual cortex after phacoemulsification and removal of the nucleus.

- For **SUBINCISIONAL CORTEX**, the side port Irrigation / Aspiration system eliminates difficulties of access and provides superior chamber maintenance.
- For **SMALL PUPILS**, the Irrigation handpiece can retract the Iris for better visualization during aspiration.
- For **DENSE NUCLEUS**, the Irrigation cannula can crush nuclear chips and epi nuclear material into the port of the Aspiration cannula.
- For **HIGHLY RETENTIVE VISCOELASTIC**, the Irrigation cannula can wash the viscoelastic from behind the IOL before Aspiration.
- For **POSTERIOR CAPSULE**, the textured surface of the cannula may be used to polish and the posterior capsule.

20 Gauge

- AAT 7412 20G Aspiration 0.5mm Port
- AAT 7436 A 20G Aspiration Sand Blasted
- AAT 7412 A 20G Aspiration Conical Tip
- AAT 7412 B 20G Aspiration Front Open
- AAT 7412 C 20G Aspiration Dual Over Ports 0.3mmx0.4mm
- AAT 7432 20G Irrigation 0.50mm Port
- AAT 7437 A 20G Irrigation Sand Blasted
- AAT 7432 A 20G Irrigation Conical Tip
- AAT 7432 B 20G Irrigation Front Open
- AAT 7432 C 20G Irrigation Dual Over Ports 0.3mmx0.4mm

22 Gauge

- AAT 7413 A 22G Aspiration 0.3mm Port
- AAT 7436 D 22G Aspiration Sand Blasted
- AAT 7413 E 22G Aspiration Conical Tip
- AAT 7413 F 22G Aspiration Front Open
- AAT 7413 G 22G Aspiration Dual Over ports 0.3mmx0.4mm
- AAT 7433 A 22G Irrigation 0.5mm Port
- AAT 7437 D 22G Irrigation Sand Blasted
- AAT 7433 E 22G Irrigation Conical Tip
- AAT 7433 F 22G Irrigation Front Open
- AAT 7433 G 22G Irrigation Dual Over Ports 0.3mmx0.4mm

21 Gauge

- AAT 7413 21G Aspiration 0.5mm Port
- AAT 7436 B 21G Aspiration Sand Blasted
- AAT 7413 B 21G Aspiration Conical Tip
- AAT 7413 C 21G Aspiration Front Open
- AAT 7413 D 21G Aspiration Dual Over Ports 0.3mmx0.4mm
- AAT 7433 21G Irrigation 0.50mm Port
- AAT 7437 B 21G Irrigation Sand Blasted
- AAT 7433 B 21G Irrigation Conical Tip
- AAT 7433 C 21G Irrigation Front Open
- AAT 7433 D 21G Irrigation Dual Over Ports 0.3mmx0.4mm

23 Gauge

- AAT 7414 23G Aspiration 0.3mm Port
- AAT 7436 C 23G Aspiration Sand Blasted
- AAT 7414 A 23G Aspiration Conical Tip
- AAT 7414 B 23G Aspiration Front Open
- AAT 7414 C 23G Aspiration Dual Over Ports 0.3mmx0.4mm
- AAT 7434 23G Irrigation 0.3mm Port
- AAT 7437 C 23G Irrigation Sand Blasted
- AAT 7434 A 23G Irrigation Conical Tip
- AAT 7434 B 23G Irrigation Front Open
- AAT 7434 C 23G Irrigation Dual Over Ports 0.3mmx0.4mm

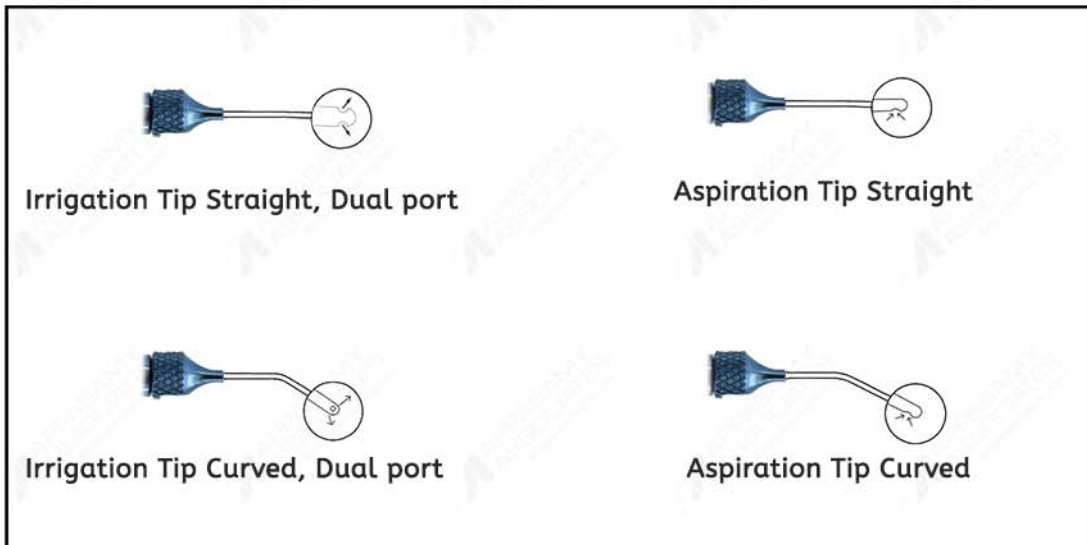

- Tip Interchangeable
- Designed for use in either side port
- Irrigation Handpiece - Gold colour
- Light Weight
- Autoclavable
- Aspiration Handpiece - Blue

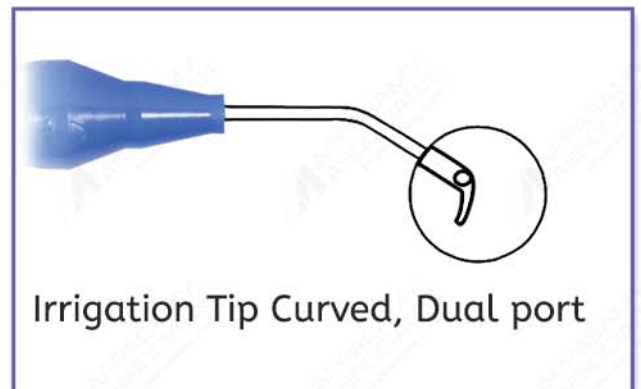
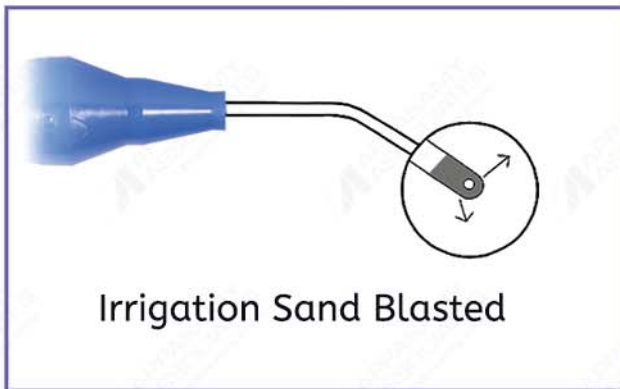
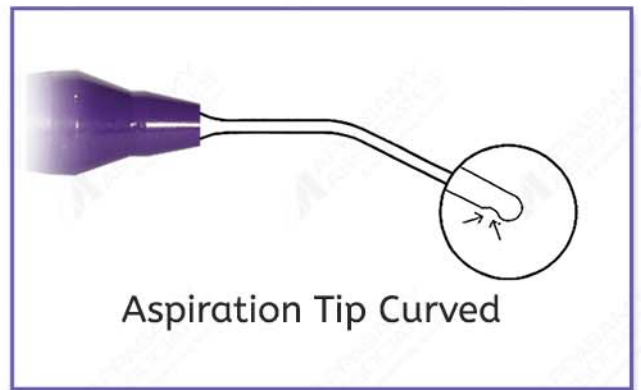
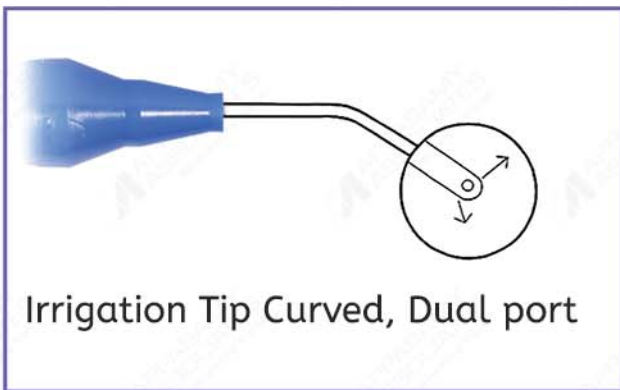
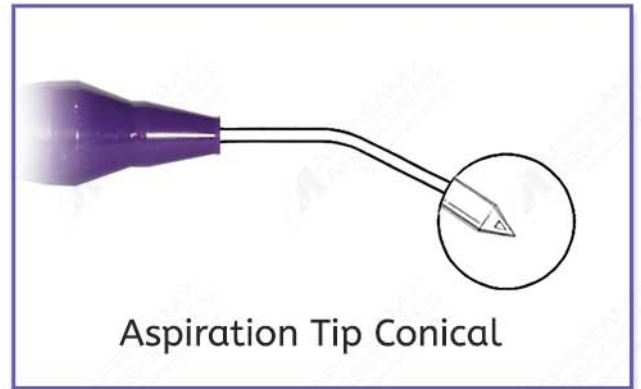
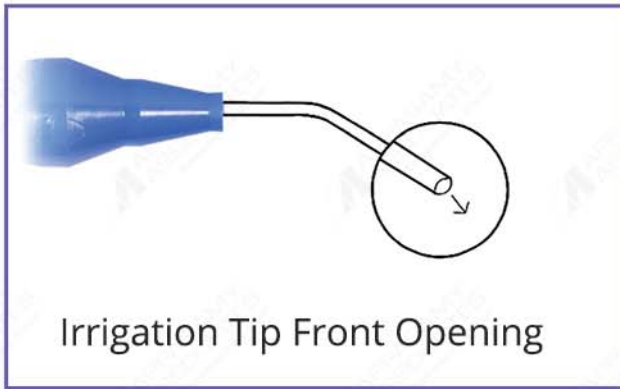

20 Gauge

AAD 7412	20G Aspiration 0.5mm Port
AAD 7436 A	20G Aspiration Sand Blasted
AAD 7412 A	20G Aspiration Conical Tip
AAD 7412 B	20G Aspiration Front Open
AAD 7412 C	20G Aspiration Dual Over Ports 0.3mmx0.4mm
AAD 7432	20G Irrigation 0.50mm Port
AAD 7437 A	20G Irrigation Sand Blasted
AAD 7432 A	20G Irrigation Conical Tip
AAD 7432 B	20G Irrigation Front Open
AAD 7432 C	20G Irrigation Dual Over Ports 0.3mmx0.4mm

21 Gauge

AAD 7413	21G Aspiration 0.5mm Port
AAD 7436 B	21G Aspiration Sand Blasted
AAD 7413 B	21G Aspiration Conical Tip
AAD 7413 C	21G Aspiration Front Open
AAD 7413 D	21G Aspiration Dual Over Ports 0.3mmx0.4mm
AAD 7433	21G Irrigation 0.50mm Port
AAD 7437 B	21G Irrigation Sand Blasted
AAD 7433 B	21G Irrigation Conical Tip
AAD 7433 C	21G Irrigation Front Open
AAD 7433 D	21G Irrigation Dual Over Ports 0.3mmx0.4mm

22 Gauge

AAD 7413 A	22G Aspiration 0.3mm Port
AAD 7436 D	22G Aspiration Sand Blasted
AAD 7413 E	22G Aspiration Conical Tip
AAD 7413 F	22G Aspiration Front Open
AAD 7413 G	22G Aspiration Dual Over Ports 0.3mmx0.4mm
AAD 7433 A	22G Irrigation 0.5mm Port
AAD 7437 D	22G Irrigation Sand Blasted
AAD 7433 E	22G Irrigation Conical Tip
AAD 7433 F	22G Irrigation Front Open
AAD 7433 G	22G Irrigation Dual Over Ports 0.3mmx0.4mm

23 Gauge

AAD 7414	23G Aspiration 0.3mm Port
AAD 7436 C	23G Aspiration Sand Blasted
AAD 7414 A	23G Aspiration Conical Tip
AAD 7414 B	23G Aspiration Front Open
AAD 7414 C	23G Aspiration Dual Over Ports 0.3mmx0.4mm
AAD 7434	23G Irrigation 0.3mm Port
AAD 7437 C	23G Irrigation Sand Blasted
AAD 7434 A	23G Irrigation Conical Tip
AAD 7434 B	23G Irrigation Front Open
AAD 7434 C	23G Irrigation Dual Over Ports 0.3mmx0.4mm

AAT 7380 Round Handle with curved tip

AAT 7381 Round Handle

AAT 7382 Straight Tip: 0.3mm Aspiration Port.Used For Initial Cortical extraction.

16G Irrigation Cannula.

AAT 7383 Curved Tip: 0.3mm Aspiration Port.Used for Initial Cortical extraction.

16G Irrigation Cannula.

AAT 7383A Curved Tip With Pin:0.3mm Aspiration Port.Used for Initial Cortical extraction.

16G Irrigation Cannula.

AAT 7384 45° Angle Tip:0.3mm Aspiration Port.Used for Peripheral Cortical extraction16G Irrigation Cannula.

AAT 7385 90° Angle Tip:0.3mm Aspiration Port.Used for Peripheral Cortical extraction16G Irrigation Cannula.

AAT 7385A 90° Angle Tip:0.3mm Aspiration Port.Used for Peripheral Cortical extraction16G Irrigation Cannula.

AAT 7386 Binkhorst Tip:150° return.0.3mm open end.Used for Cotical extraction at 12 o' clock. Return is designed for a 3mm Wound insertion.16 G Irrigation Cannula.

AAT 7386A Binkhorst Tip with pin:150° return.0.3mm open end.Used for Cotical extraction at 12 o' clock. Return is designed for a 3mm Wound insertion.16 G Irrigation Cannula.

AAT 7393 Round handle for silicone Tip

0.3mm Aspiration Port. 19G Aspiration Cannula

AAT 7394 Straight Silicone Sleeve Tip

0.3mm Aspiration Port. 19G Aspiration Cannula

AAT 7395 45° Angle Silicone Sleeve Tip

0.3mm Aspiration Port. 19G Aspiration Cannula.

AA 7396 Replacement `O' Ring Set. (5 sets per box)

AA 7397 Round Handle with Silicone Sleeve Tip.



LIGHT WEIGHT - BALANCED RAPID TIP INTERCHANGEABLE

- I/A Probe Sleeve Closed - **AAT 7382**
- I/A Probe Sleeve Straight - **AAT 7383**
- I/A Probe Sleeve Angled 45° - **AAT 7385**
- I/A Probe Sleeve Open - **AAT 7393/94**

I/A Tip

S-Curved Polished
It's Complete Cleaning Capability
Helps to Avoid possible Contamination
Compatible to all Popular Phaco Consoles. Fits Multiples Sleeves.
All Titanium, Universal Fitting
Allows One to Use This Handle with Various I/A Tips.

- AAT 7398 / AAD 7398** Straight
- AAT 7398 A / AAD 7398 A** Curved
- AAT 7398 B / AAD 7398 B** Cobra Curved



AA - Stainless Steel, AAT - Titanium, AAD - Disposable Instruments

ELITE TURBO IRRIGATING CHOPPERS

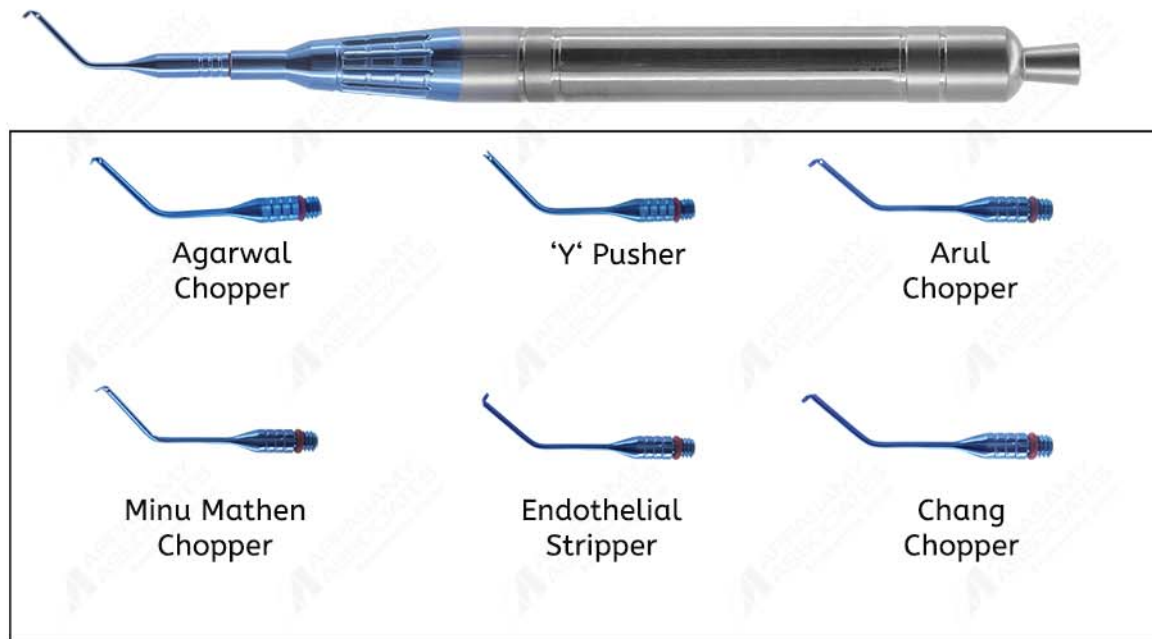

- AAT 8300** Agarwal Turbo Irrigating Chopper Sharp Edge 20 Gauge Tip angled 90° Set
- AAT 8301** Agarwal Turbo Irrigating Chopper Sharp Edge 20 Gauge Tip angled 90° Tip only
- AAT 8302** Agarwal Turbo Irrigating Chopper Sharp Edge 20 Gauge Tip angled 110° Set
- AAT 8303** Agarwal Turbo Irrigating Chopper Sharp Edge 20 Gauge Tip angled 110° Set only
- AAT 8305** Arul Turbo Irrigating Chopper 20 Gauge Tip Set
- AAT 8306** Arul Turbo Irrigating Chopper 20 Gauge Tip Only
- AAT 8310** Chang Irrigating Chopper 20 Gauge Tip Set
- AAT 8311** Chang Irrigating Chopper 20 Gauge Tip only
- AAT 8315** Minu Mathen Irrigating Chopper 20 Gauge Tip Set
- AAT 8316** Minu Mathen Irrigating Chopper 20 Gauge Tip Only
- AAT 8320** Irrigating 'Y' Pusher 20 Gauge Tip Set
- AAT 8321** Irrigating 'Y' Pusher 20 Gauge Tip Only
- AAT 8325** Irrigating Endothelial Stripper 20 Gauge Tip Set
- AAT 8326** Irrigating Endothelial Stripper 20 Gauge Tip Only
- AAT 8350** Elite Irrigating Chopper Set
- AAT 8410** Irrigating Chopper Aspirating Handle
- AAT 8411** Irrigating Chopper Irrigating Handle
- AAT 8420** Turbo Irrigating Seibel Chopper
- AAT 8421** Turbo Irrigating Nagahara Chopper

APPA MICS
(MICRO INCISION CATARACT SURGERY)

Agarwal
Turbo Irrigating Chopper
1mm Fully Cutting Edge
20G 90° Tip.
AAT 8300



Bi-Manual I/A System
21 G Aspiration /
20 G Irrigation
AAT 7410/11



Phakonit Phaco Tip
Without Groove
0.5mm I.D., 0.7mm O.D. (23G)
Available in 0°, 15°, 30°
AAT 7417



Kreshner
Micro Incision
Capsulorhexis Forceps
AAT 3871 20 G
AAT 3872 23 G



Ultra Thin Phakonit Blade
AA 572014 Width 1.4mm
AA 572018 Width 1.8mm



 SURGERY INSTRUMENTS SETS

AA - Stainless Steel, AAT - Titanium, AAD - Disposable Instruments

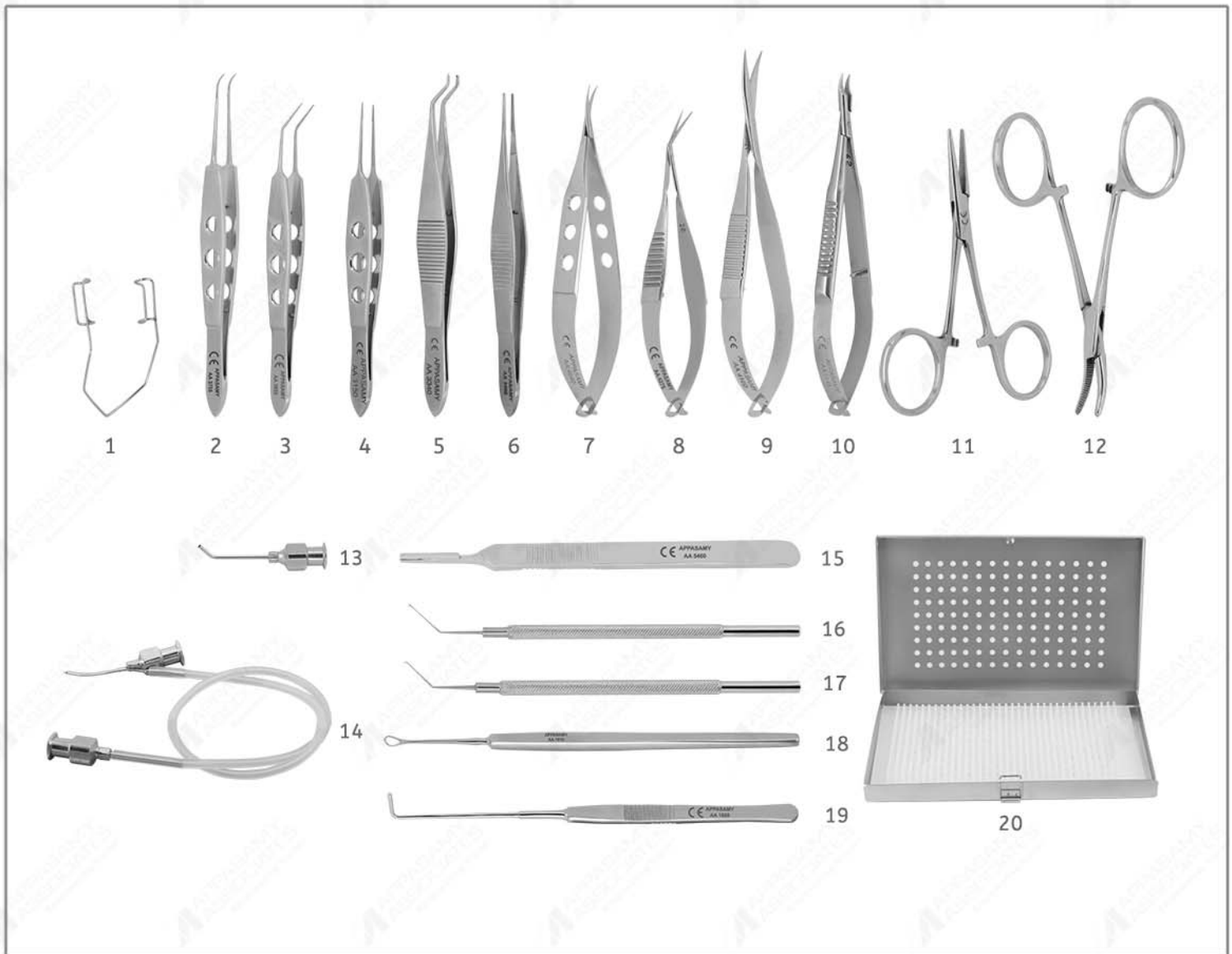

- | | |
|---|--|
| 1.AA 1009 Barraquer Wire Speculum, Large | 14.AA 7420 Simcoe I/A Cannula, Direct |
| 2.AA 3755 Suture Tying Forceps, Curved | 15.AA 5460 Bard- Parker Handle #3 Flat |
| 3.AA 3805 Mc Pherson Forceps, Angled | 16.AA 1993 Agarwal Phaco Chopper |
| 4.AA 3150 McPherson Corneal Forceps, 1 x 2 Teeth | 17.AA 1465 Sinskey II Lens Manipulating Hook |
| 5.AA 3340 Superior Rectus Forceps | 18.AA 1915 Lewis Lens Loop Small |
| 6.AA 3460 Wills Hospital Utility Forceps | 19.AA 1860 Smith Lens Expressor |
| 7.AA 4040 Castroviejo Corneal Scissors Small Blades | 20.AA 8005 Sterlization Box |
| 8.AA 4275 Vannas Capsulotomy Scissors, Universal | |
| 9.AA 4180 Westcott Stitch Scissors | |
| 10.AA 5145 Barraquer Needle Holder Short, Micro Jaws,W/O Lock | |
| 11.AA 3920 Hartman Mosquito Forceps Straight | |
| 12.AA 3925 Hartman Mosquito Forceps Curved | |
| 13.AA 7105 Rycraft Air Injection Cannula | |

AA - Stainless Steel, AAT - Titanium, AAD - Disposable Instruments

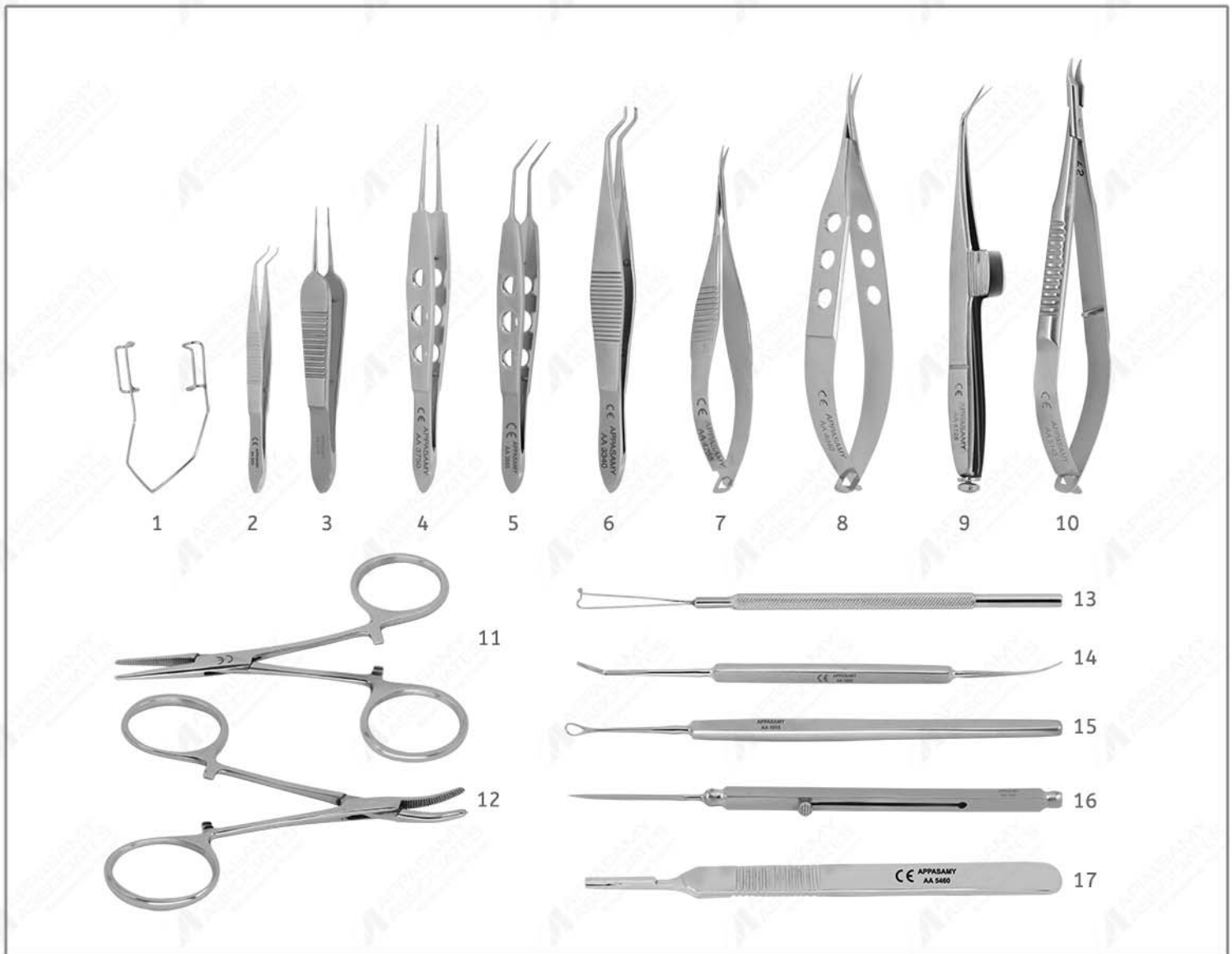

1. AA 1009 Barraquer Wire Speculum
2. AA 3025 Hess Iris Forceps
3. AA 3275 St. Martin Suturing Forceps
4. AA 3750 Jaffe Tying Forceps (Straight)
5. AA 3805 Mc Pherson IOL Forceps Angled 11mm
6. AA 3340 Superior Rectus Forceps,
7. AA 4255 Vannas Capsulotomy Scissors Curved
8. AA 4040 Castroviejo Corneal Scissors Universal
9. AA 4125 De Wecker's Iris Scissors
10. AA 5145 Barraquer Needle Holder, Micro
11. AA 3920 Hartman Mosquito Forceps Straight
12. AA 3925 Hartman Mosquito Forceps Curved
13. AA 1250 Dastoor Iris Retractor Straight
14. AA 1685 Koman Nair Iris Spatula
15. AA 1915 Lewis Lens Loop Small
16. AA 1350 Barraquer Cataract Knife ,Sliding
17. AA 5460 Bard- Parker Handle

AA - Stainless Steel, AAT - Titanium, AAD - Disposable Instruments

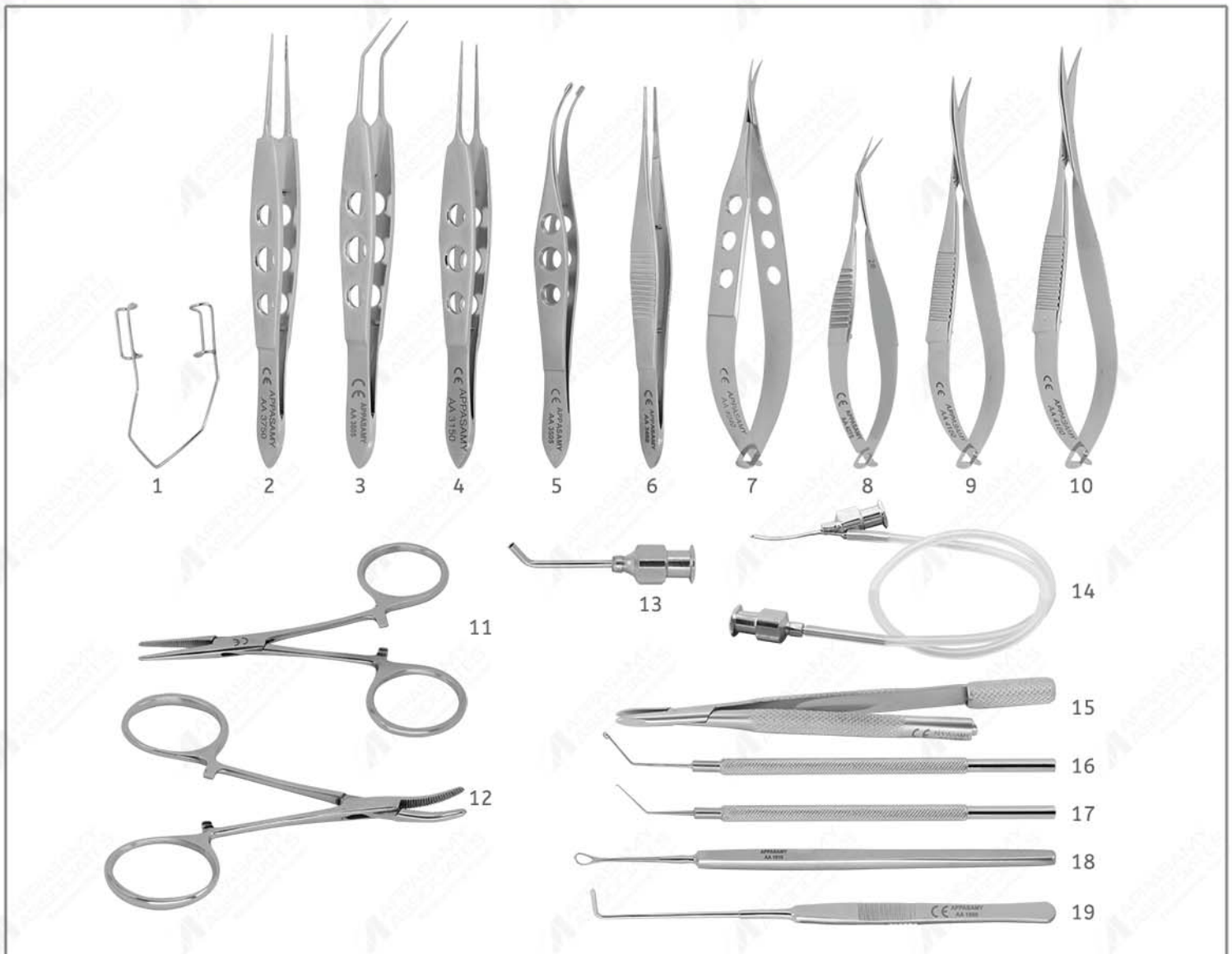

1. AA 1009 Barraquer Wire Speculum, Large
2. AA 3750 Jaffe Tying Forceps, Straight
3. AA 3805 Mc Pherson Forceps Angled
4. AA 3150 McPherson Corneal Forceps 1 x 2 Teeth
5. AA 3505 Arruga Capsule Forceps
6. AA 3460 Wills Hospital Utility Forceps
7. AA 4040 Castroviejo Corneal Scissors Universal
8. AA 4275 Vannas Capsulotomy Scissors Angled
9. AA 4180 Westcott Stitch Scissors
10. AA 5145 Barraquer Needle Holder, Micro Jaws W/O Lock
11. AA 3920 Hartman Mosquito Forceps Straight
12. AA 3925 Hartman Mosquito Forceps Curved
13. AA 7105 Rycroft Air Injection Cannula
14. AA 7420 Simcoe I/A Cannula, Direct
15. AA 5405 Castroviejo Blade Breaker
16. AA 1911 Nightingale Capsule Polisher (P.C)
17. AA 1465 Sinskey II Lens Manipulating Hook
18. AA 1915 Lewis Lens Loop, Small
19. AA 1860 Smith Lens Expressor

AA - Stainless Steel, AAT - Titanium, AAD - Disposable Instruments

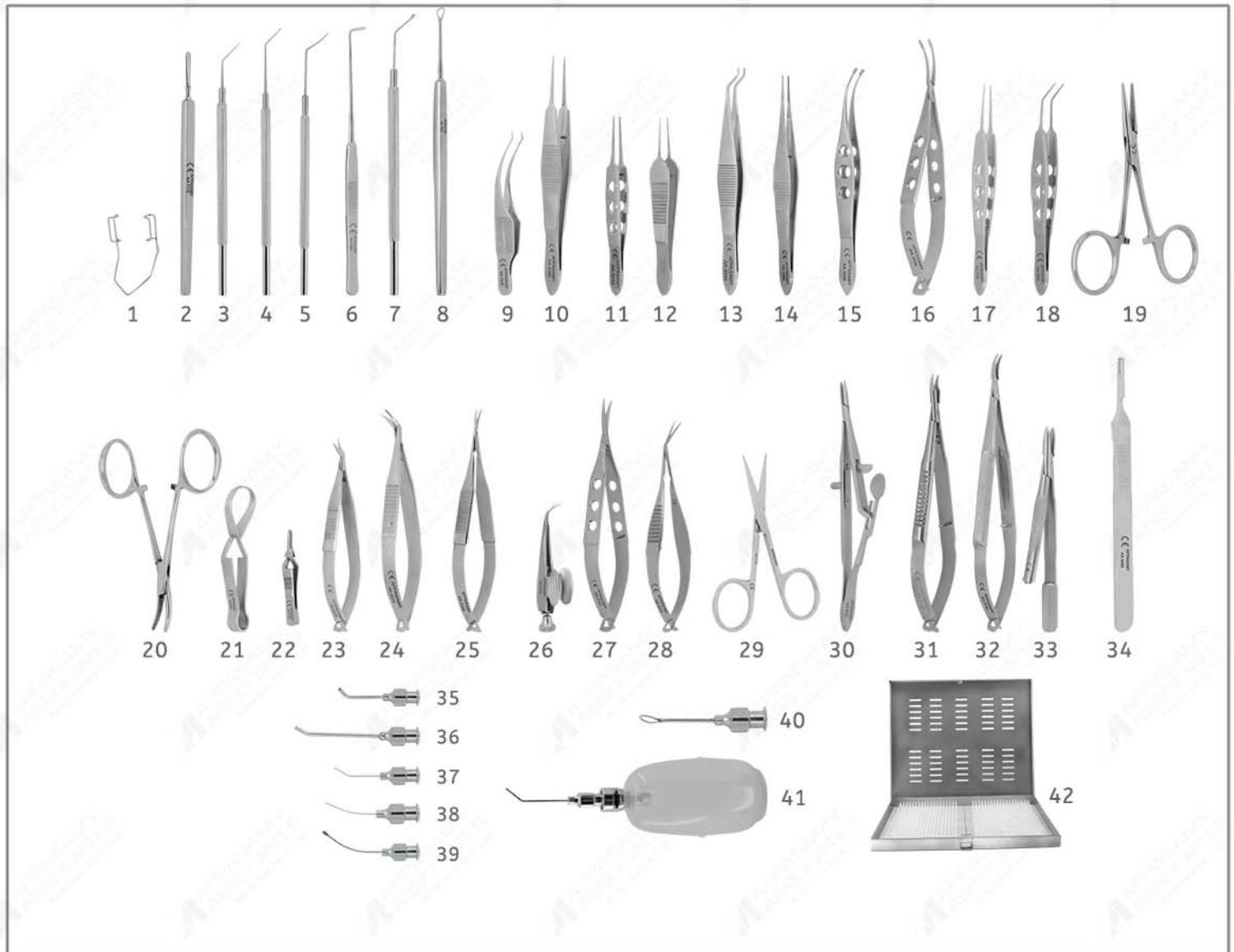

- | | |
|--|---|
| <ul style="list-style-type: none"> 1.AA 1009 Barraquer Wire Speculum, Large 2.AA 1370 Tooke Corneal Knife 3.AA 1465 Sinsky II Lens Manipulating Hook Angled 4.AA 1515 Kuglen Iris Hook, Angled 5.AA 1655 Barraquer Iris Spatula 0.25mm, Angled 6.AA 1860 Smith Lens Expressor 7.AA 1911 Nightingale Capsule Polisher Posterior 8.AA 1915 Lewis Lens Loop Small 9.AA 3030 Colibri Forceps 1x2 Teeth 0.12mm 10.AA 3180 Castroviejo Suturing Forceps 0.12mm, 1x2 Teeth 11.AA 3255 Bishop-Harmon Tissue Forceps Delicate 0.8mm 12.AA 3275 St.Martin Suturing Forceps 1x2 teeth 13.AA 3340 Dastoor Superior Rectus Forceps, 1x2 Teeth 14.AA 3460 Wills Hospital Utility Forceps 15.AA 3505 Arruga Capsule Forceps 16.AA 3690 Shepard IOL Forceps 17.AA 3790 Mc Pherson Tying Forceps Long Handle 18.AA 3805 Mc Pherson IOL Forceps 11mm Angled 19.AA 3920 Hartman Mosquito Forceps Straight 20.AA 3925 Hartman Mosquito Forceps Curved 21.AA 3945 Baby Jones Towel Clamp | <ul style="list-style-type: none"> 22.AA 3950 Serrefine Small Straight 23.AA 4010 Castroviejo Corneoscleral Scissors[s] blade Left 24.AA 4015 Castroviejo Corneoscleral Scissors [s] blade Right 25.AA 4100 Micro Iris Scissors Cur Pointed Small Blades 26.AA 4120 Barraquer Iris Scissors 27.AA 4155 Westcott Tenotomy Scissors 28.AA 4275 Vannas Capsulotomy Scissors Angle Forward 11mm 29.AA 4500 Iris Scissors Straight 3.5" Length 30.AA 5020 Kalt Needle Holder Straight 31.AA 5145 Barraquer N.Holder Short Model Micro Jaws, Without Lock 32.AA 5185 Barraquer N.Holder Standard Jaws, Curved w/o Lock 33.AA 5420 Swiss Model Blade Breaker and Holder, Small 34.AA 5460 Bard- Parker Handle #3 Flat 35.AA 7105 Anterior Chamber Cannula Curved 90deg. 27g 36.AA 7145 Anterior Chamber Washout Cannula 16G 37.AA 7205 Pearce Hydro Dissection Cannula 35° Angled, 18G 38.AA 7230 Kellan Hyderodelineation Cannula Curved Bevel Tip 18G 39.AA 7605 Jensen Capsule Polisher Sand Blast Olive Tip, 23g 40.AA 7705 Knolle-Pearce Irrigating Vectis [4mm Wide, 7mm Long loop] 41.AA 7830 Silicone Bulb With Adaptor 42.AA 8020 Appasamy Sterilization Tray With Two Silicone Mats |
|--|---|

AA - Stainless Steel, AAT - Titanium, AAD - Disposable Instruments

Mini-Nucleus Technique (Blumenthal)



Snare Nucleus Dividing Technique



Kansas / Mc Intyre Nucleus Dividing Technique

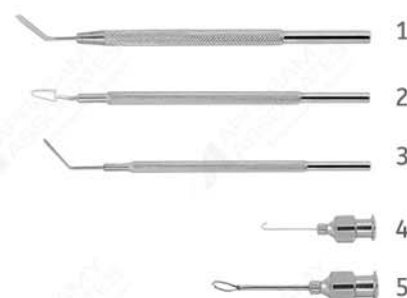

Mini-Nucleus Technique (Blumenthal)

1. AA 1009 Barraquer Wire Speculum, Large
2. AA 1817 Shepard Fixation Ring
3. AA 1993 Agarwal Phaco Chopper 1mm Fully Cutting Edge
4. AA 3030 Barraquer Colibri Forceps 1x2 Teeth 0.12mm
5. AA 3180 Castroviejo Suturing Forceps 0.12mm, 1x2 Teeth
6. AA 5420 Swiss Model Blade Breaker and Holder, Small
7. AA 560012 Lance Blade
8. AA 561021 Tunnel Blade
9. AA 562028 Slit Blade
10. AA 7150 Lewickly Anterior Chamber Maintainer Cannula
11. AA 7200 Blu Mental Cannula 25 G
12. AA 7201 Blu Mental Cannula 27G
13. AA 7202 IOL Glide Silicon 35mm Length x 5mm Wide
14. AA 7960 Infusion Cannula Size 2.5mm

Snare Nucleus Dividing Technique

1. AA 1935 Keener-Arlt Lens Loop Strong Curve
2. AA 3908 Kansas Nucleus Removal Forceps straight
3. AA 7215 Gimbel Shaped Hydrodissector, 25G
4. AA 7705 Knolle-Pearce Irrigating Vectis [4mm Wide, 7mm Long Loop]
5. AA 1917 Appa -Snare Nucleus Dividing Snare, Complete Set

Kansas / Mc Intyre Nucleus Dividing Technique

1. AA 1965 Kansas Nucleus Bisector
2. AA 1970 Kansas Nucleus Trisector Right
3. AA 1975 Kansas Nucleus Vectis Solid Right
4. AA 7215 Gimbel Shaped Hydrodissector, 25G
5. AA 7705 Knolle-Pearce Irrigating Vectis [4mm Wide, 7mm Long Loop]

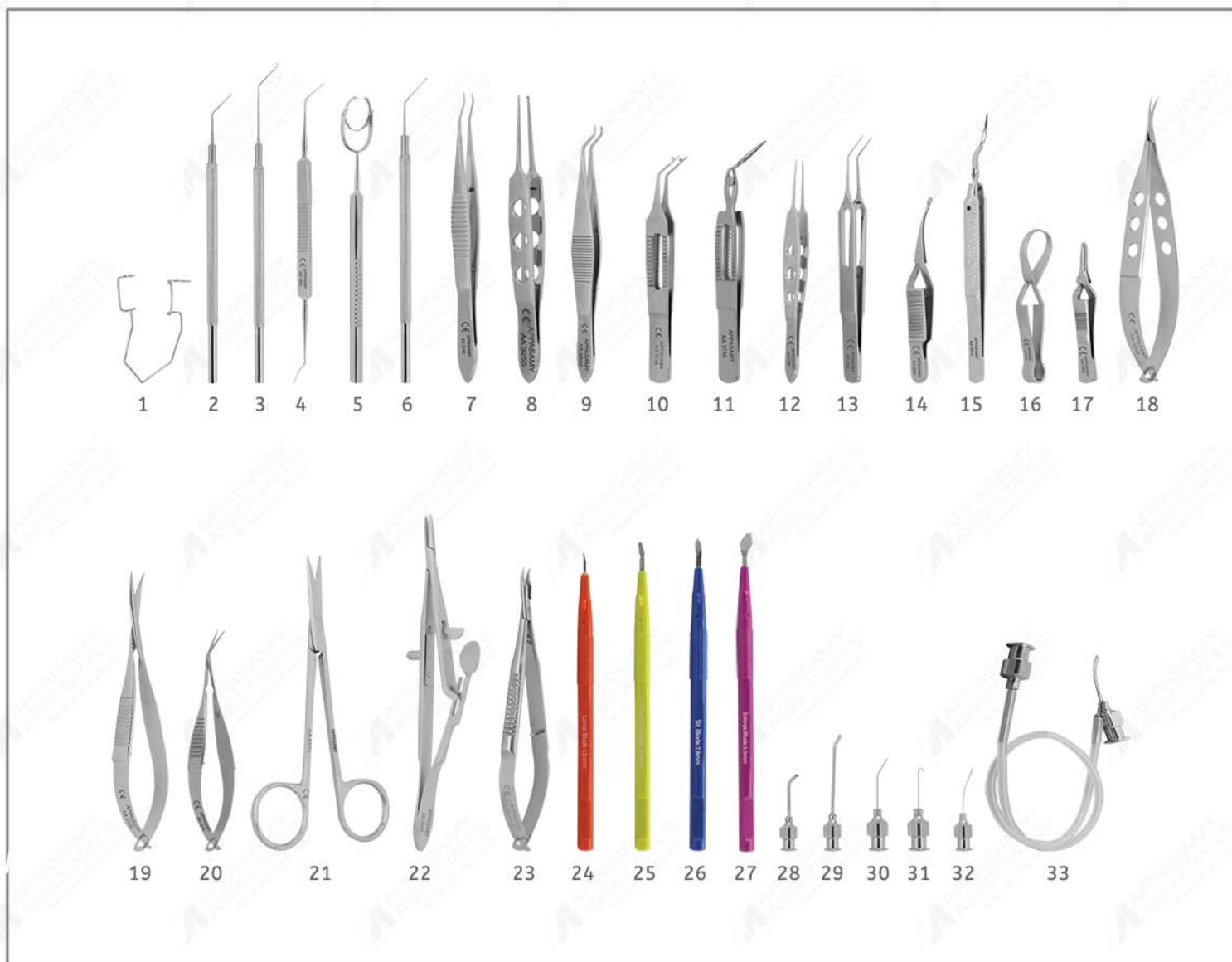

- 01.AA 1025 Kratz -Barraquer Wire Speculum,Big
- 02.AA 1465 Sinsky II Lens Manipulating Hook Angled
- 03.AA 1597 Akahoshi Nucleus Ball Sustainer
- 04.AA 1682 Castroviejo Cyclodialysis Spatula, 0.50 mm Wide
- 05.AA 1817 Shepard Fixation Ring
- 06.AA 1993 Agarwal Phaco Chopper 1mm Fully cutting Edge
- 07.AA 3145 Lim's Corneoscleral Forceps 0.12mm,1 x 2 Teeth
- 08.AA 3255 Bishop-Harmon Tissue Forceps Delicate 0.8mm
- 09.AA 3340 Dastoor Superior Rectus Forceps,1x2 Teeth
- 10.AA 3742 Appasamy Lens Folding Forceps
- 11.AA 3744 Appasamy Lens Inserting Forceps Cross Action
- 12.AA 3790 Mc Pherson Tying Forceps St. Long Handle
- 13.AA 3855 Utrata Capsulorhexis Forceps Flat Handle
- 14.AA 3906 Dodick Nucleus Cracking Forceps
- 15.AA 3914 Akahoshi Phaco Prechopper Curved
- 16.AA 3945 Baby Jones Towel Clamp
- 17.AA 3950 Serrefine Small Straight

- 18.AA 4040 Castroviejo Corneal Scissors Small Blades
- 19.AA 4180 Westcott Stitch Scissors
- 20.AA 4275 Vannas Capsulotomy Scissors Angle Forward 11mm
- 21.AA 4510 Eye Scissors Straight 4 1/2"Length
- 22.AA 5020 Kalt Needle Holder Straight
- 23.AA 5145 Barraquer N.Holder Short Model Micro Jaws,without Lock
- 24.AA 560012 Lance Blade
- 25.AA 561021 Tunnel Blade
- 26.AA 562028 Slit Blade
- 27.AA 563050 Slit Enlarge Blade
- 28.AA 7105 Recroft Air Injection annula 23G
- 29.AA 7145 Anterior Chamber Washout Cannula 16G
- 30.AA 7205 Pearce Hydrodissection Cannula , 35deg.Angled 25G
- 31.AA 7215 Gimbel Shaped Hydrodissector,25G
- 32.AA 7230 Kellan Hyderodelineation Cannula Curved Bevel Tip 25G
- 33.AA 7420 Simcoe I/A Cannula 23G `Direct`

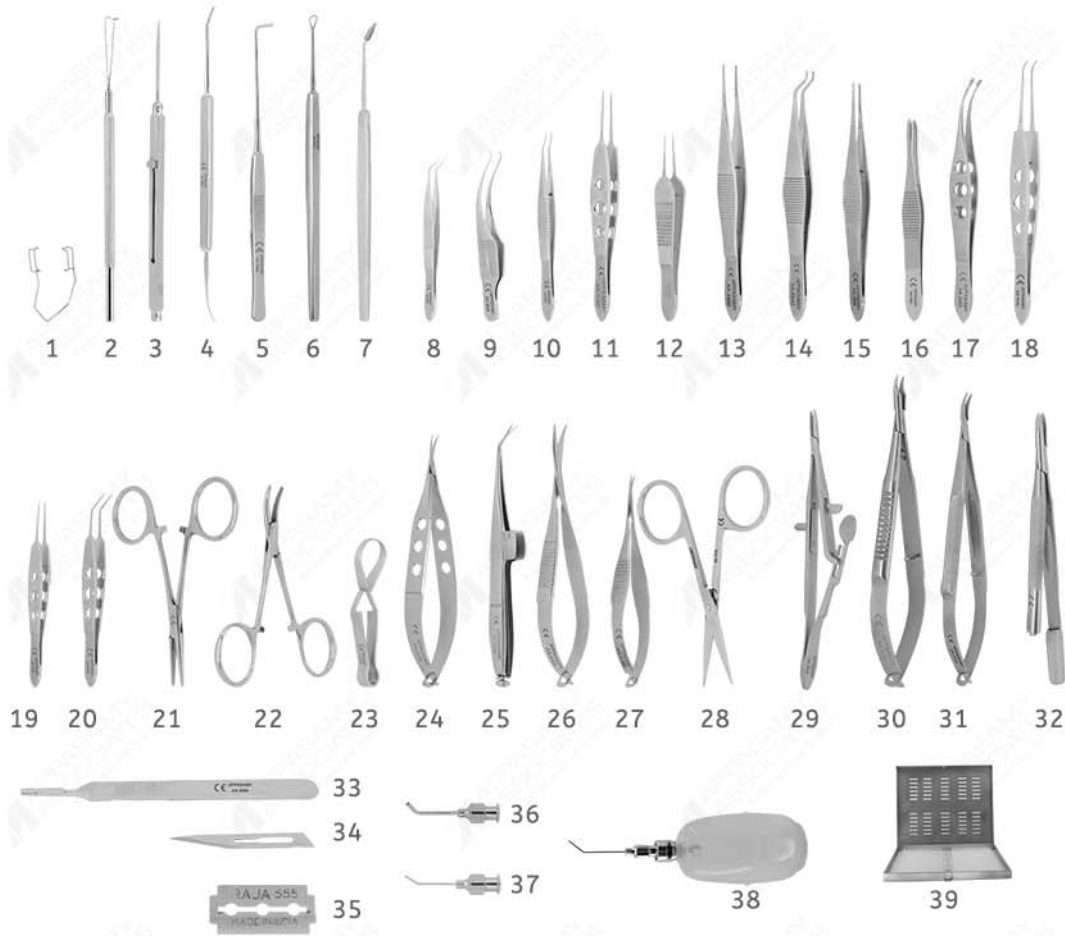

- | | |
|--|--|
| 1. AA 1009 Barraquer Wire Speculum, Large | 21. AA 3920 Hartman Mosquito Forceps Straight |
| 2. AA 1250 Dastoor Iris Retractor Straight | 22. AA 3925 Hartman Mosquito Forceps Curved |
| 3. AA 1350 Barraquer Cataract Knife in Sliding Case | 23. AA 3945 Baby Jones Towel Clamp |
| 4. AA 1685 Koman Nair Iris Spatula Double | 24. AA 4040 Castroviejo Corneal Scissors Small Blades |
| 5. AA 1860 Smith Lens Expressor | 25. AA 4125 De Wecker's Iris Scissors Sharp-Blunt |
| 6. AA 1915 Lewis Lens Loop Small | 26. AA 4180 Westcott Stitch Scissors |
| 7. AA 1963 Cautery Cone Type Copper | 27. AA 4255 Vannas Capsulotomy Scissors (Curved) |
| 8. AA 3025 Hess Iris Forceps 1x2 Teeth Standard Model | 28. AA 4500 Iris Scissors Straight 3.5" Length |
| 9. AA 3030 Barraquer Colibri Forceps 1x2 Teeth 0.12mm | 29. AA 5020 Kalt Needle Holder Straight |
| 10. AA 3145 Lim's Corneoscleral Forceps 0.12mm, 1 x 2 Teeth | 30. AA 5145 Barraquer N.Holder Short Model Micro Jaws, Without Lock |
| 11. AA 3150 McPherson Corneal Forceps St.0.4mm 1 x 2 Teeth | 31. AA 5185 Barraquer N.Holder Standard Jaws, Curved w/o Lock |
| 12. AA 3275 St. Martin Suturing Forceps 1x2 Teeth | 32. AA 5405 Castroviejo Blade Breaker and Holder, Big |
| 13. AA 3300 Fixation Forceps 1x2 Teeth | 33. AA 5460 Bard- Parker Handle #3 Flat |
| 14. AA 3340 Dastoor Superior Rectus Forceps, 1x2 Teeth | 34. AA 5560 Bard-Parker Blade |
| 15. AA 3460 Wills Hospital Utility Forceps | 35. AA 5570 Carbon Razor Breakable Blade |
| 16. AA 3485 Beer Cilia Forceps | 36. AA 7105 Rycroft Air Injection Cannula 23G |
| 17. AA 3505 Arruga Capsule Forceps | 37. AA 7135 Bishop Harmon Anterior Chamber Cannula 19G |
| 18. AA 3755 Jaffe Tying Forceps Curved | 38. AA 7830 Silicone Bulb With Adaptor |
| 19. AA 3790 IMc Pherson Tying Forceps St. Long Handle | 39. AA 8020 Appasamy Sterilization Tray with Two Silicone Mats |
| 20. AA 3805 Mc Pherson IOL Forceps 11mm Angled | |

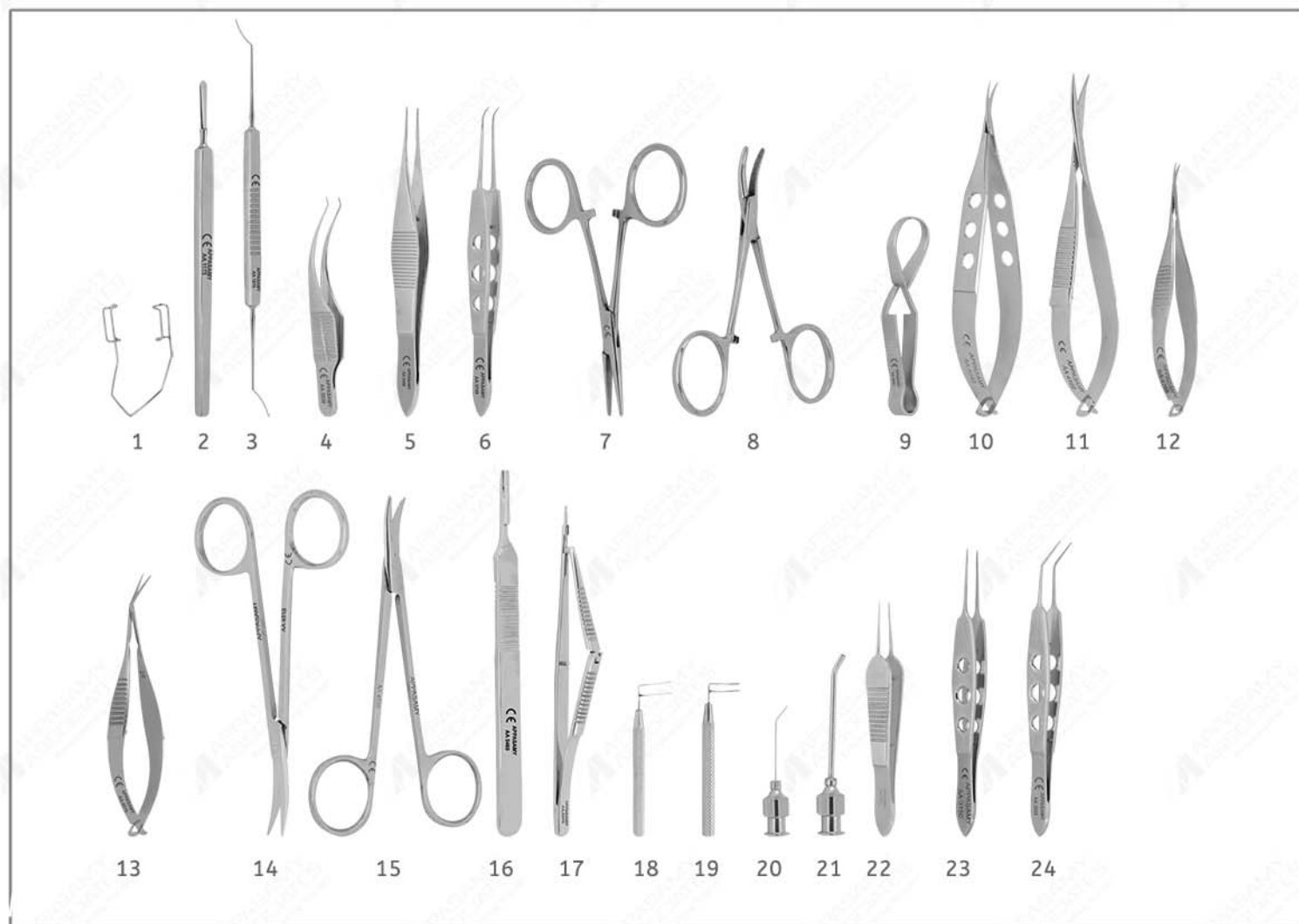

Mini-Nucleus Technique (Blumenthal)

- 1.AA 1009 Barraquer Wire Speculum, Large
- 2.AA 1370 Tooke Corneal Knife
- 3.AA 1670 Castroviejo Synechia Spatula, Double Ended
- 4.AA 3030 Barraquer Colibri Forceps 1x2 Teeth 0.12mm
- 5.AA 3450 Eye Dressing Forceps Straight
- 6.AA 3755 Jaffe Tying Forceps Curved
- 7.AA 3920 Hartman Mosquito Forceps Straight
- 8.AA 3925 Hartman Mosquito Forceps Curved
- 9.AA 3945 Baby Jones Towel Clamp
- 10.AA 4040 Castroviejo Corneal Scissors Small Blades
- 11.AA 4180 Westcott Stitch Scissors
- 12.AA 4255 Vannas Capsulotomy Scissors (Curved)
- 13.AA 4275 Vannas Capsulotomy Scissors Angle Forward 11mm
- 14.AA 4515 Eye Scissors Curved 4 1/2" Length
- 15.AA 4535 Stevens Tenotomy Scissors Curved
- 16.AA 5460 Bard-Parker Handle #3 Flat
- 17.AA 6070 Kelly's Descement's Membrane Punch, 1.0mm
- 18.AA 6160 Harms Trabeculotomy Probe Right
- 19.AA 6170 Harms Trabeculotomy Probe Left
- 20.AA 7107 Rycroft Air Injection Cannula 27G
- 21.AA 7145 Anterior Chamber Washout Cannula 16G
- 22.AA 3275 St. Martin Suturing Forceps 1x2 Teeth
- 23.AA 3150 McPherson Corneal Forceps St. 0.4mm 1 x 2 Teeth
- 24.AA 3805 Mc Pherson IOL Forceps 11mm Angled

AA - Stainless Steel, AAT - Titanium, AAD - Disposable Instruments

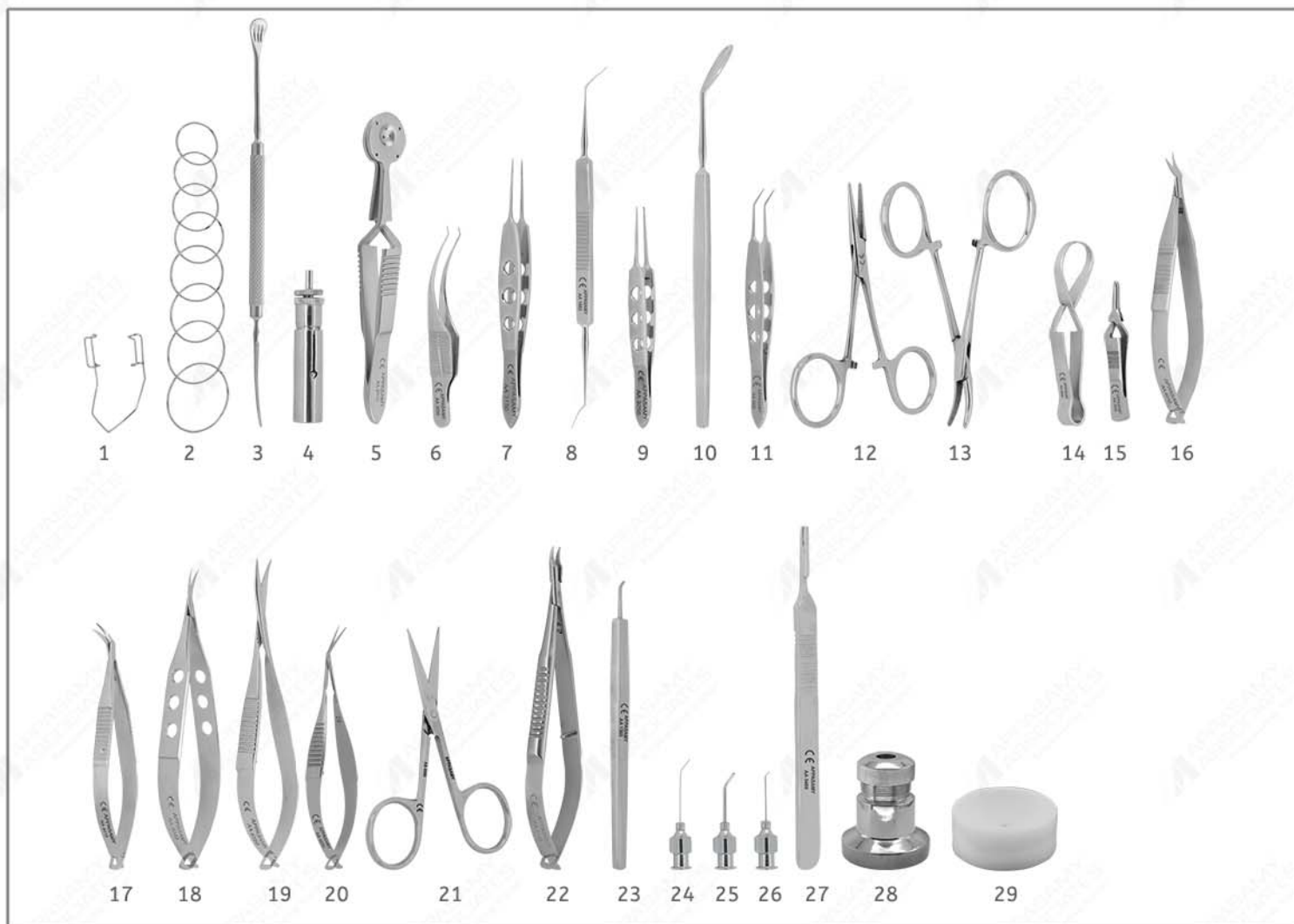

- 01.AA 1009 Barraquer Wire Speculum, Large
- 02.AA 1280 Flieringa Scleral Fixation Ring (Set of 8 sizes)
- 03.AA 1710 Paton Spatula & Spoon
- 04.AA 2015 Castroviejo Corneal Trephine Size 7.5mm Dia
- 05.AA 2070 Dastoor Corneal Graft Holding Forceps
- 06.AA 3030 Colibri Forceps 1x2 Teeth 0.12mm
- 07.AA 3150 McPherson Corneal Forceps 1 x 2 Teeth
- 08.AA 1682 Castroviejo Cyclodialysis Spatula, 0.50 mm Wide
- 09.AA 3255 Bishop-Harmon Tissue Forceps Delicate 0.8mm
- 10.AA 2040 Dastoor Keratoplasty Spatula
- 11.AA 3800 Kelman-Mc Pherson Forceps 7.5mm Angle Long Handle
- 12.AA 3920 Hartman Mosquito Forceps Straight
- 13.AA 3925 Hartman Mosquito Forceps Curved
- 14.AA 3945 Baby Jones Towel Clamp
- 15.AA 3950 Serrefine Small Straight
- 16.AA 4010 Castroviejo Corneoscleral Scissors[s] Blade Left

- 17.AA 4015 Castroviejo Corneoscleral Scissors [s] Blade Right
- 18.AA 4040 Castroviejo Corneal Scissors Small Blades
- 19.AA 4180 Westcott Stitch Scissors
- 20.AA 4275 Vannas Capsulotomy Scissors Angle Forward 11mm
- 21.AA 4500 Iris Scissors Straight 3.5" Length
- 22.AA 5145 Barraquer N.Holder Short Model Micro Jaws, Without Lock
- 23.AA 1360 Paufigue Graft Knife
- 24.AA 7107 Rycroft Air Injection Cannula 27g
- 25.AA 7125 Bracken A/C Cannula Curved 19G
- 26.AA 7130 Knolle Anterior Chamber Irrigating Cannula 23g
- 27.AA 5460 Bard-Parker Handle #3 Flat
- 28.AA 2050 Tudor Thomas Corneal Graft Stand
- 29.AA 2060 Lieberman Corneal Cutting Block Teflon

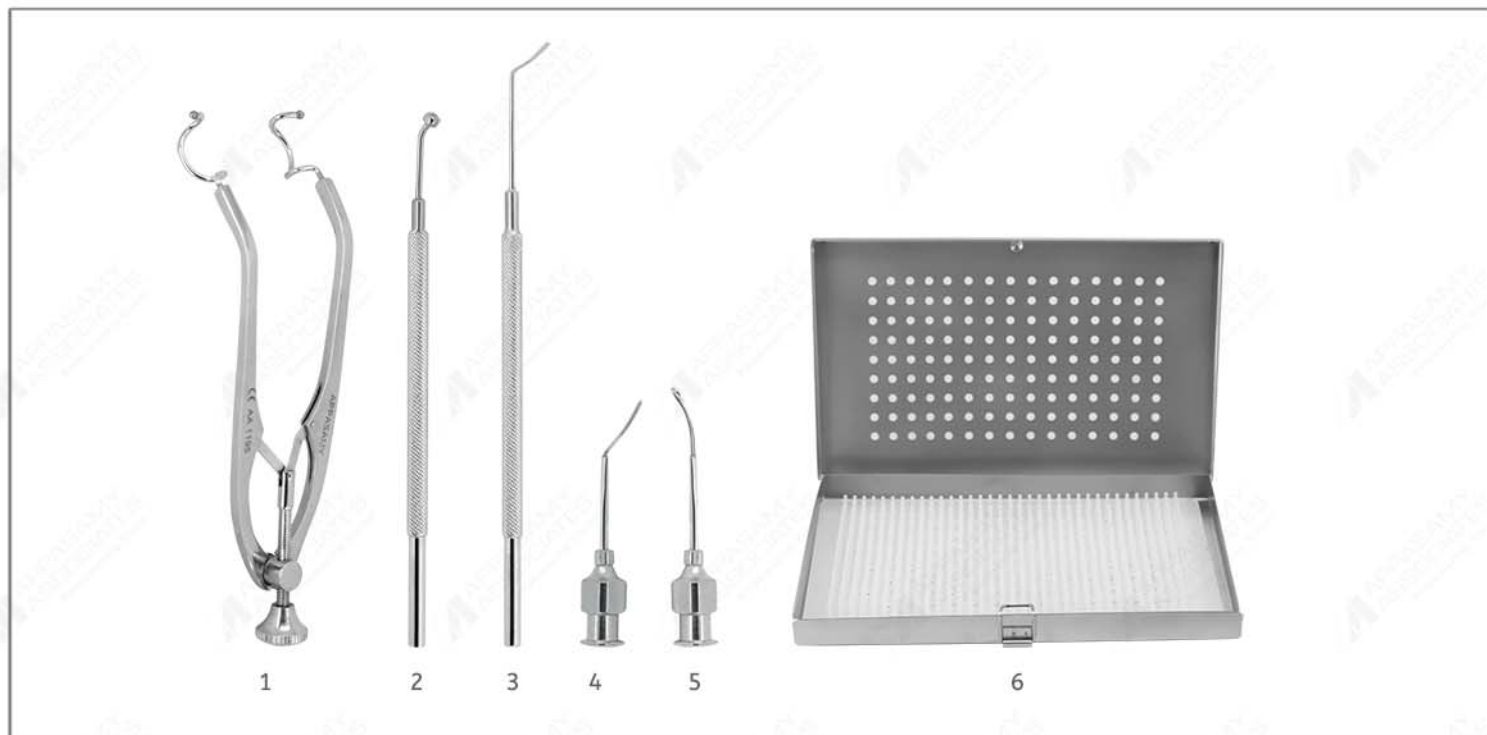

- 01.AA 1195 Castroviejo Lasik Speculum
- 02.AA 1308 Lasik Depressor
- 03.AA 1683 Lasik Spatula
- 04.AA 7855 Lasik Flap Irrigator
- 05.AA 7891 Lasik Irrigating Cannula
- 06.AA 8005 Appasamy Sterilization Box

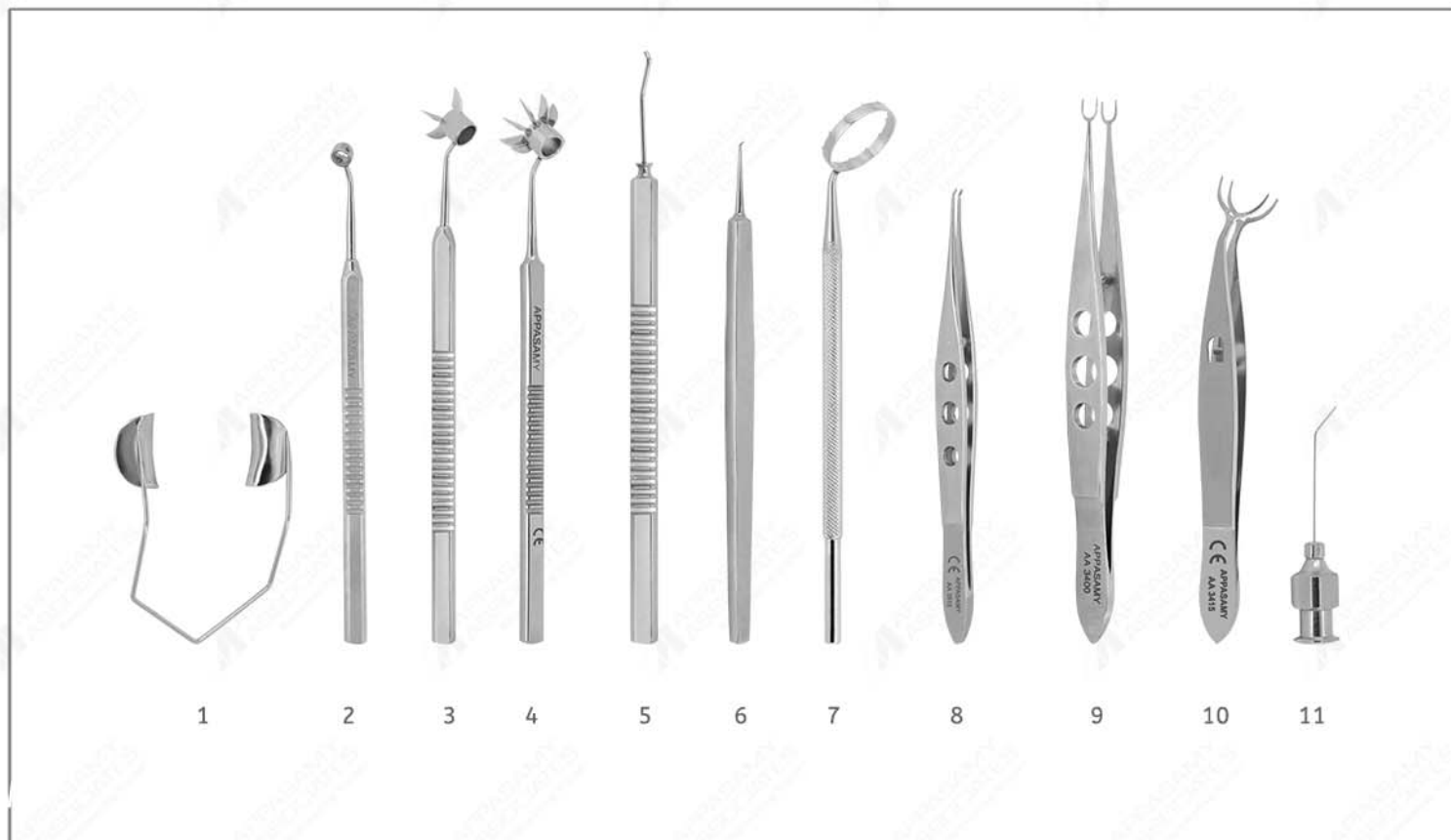

- 01.AA 1016 Barraquer Wire Speculum, Solid Blades, Large
- 02.AA 2190 Hoffer Optic Zone Marker Size (3.0mm Dia)
- 03.AA 2260 Osher-Neumann Radial Marker (4 Blades)
- 04.AA 2262 Osher-Neumann Radial Marker (8 Blades)
- 05.AA 2220 Grene Visual Axis Marker
- 06.AA 2125 Deitz Incision Depth Gauge 0.50mm
- 07.AA 1815 Thornton Fixation Ring
- 08.AA 3915 Bore's Corneal Fixation Forceps, Straight
- 09.AA 3400 Bore's Incision Spreading Forceps
- 10.AA 3415 Kramer Corneal Fixation Forceps
- 11.AA 7107 Air Injection Cannula 27G

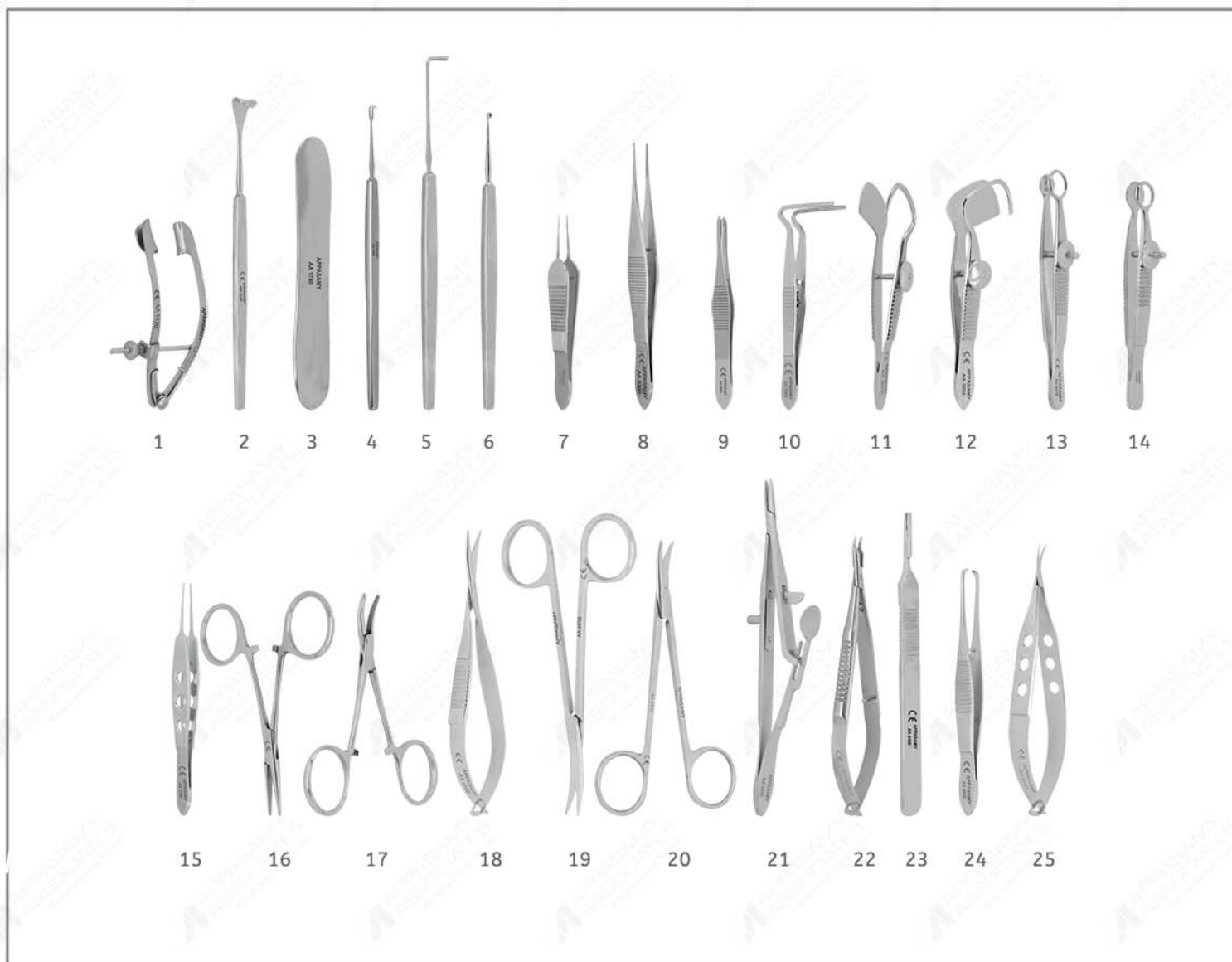

- 01.AA 1120 Lancaster Eye Speculum
- 02.AA 1260 Desmarres Lid Retractor Size 0
- 03.AA 1740 Jaeger Lid Plate
- 04.AA 1810 Fixation Hook Double Sharp 2.0 x 1.5 mm Small
- 05.AA 1827 Graefe Muscle Hook Size 3
- 06.AA 1877 Meyerhoefer Chalazion Curette Size 2
- 07.AA 3275 St. Martin Suturing Forceps 1x2 Teeth
- 08.AA 3300 Fixation Forceps 1x2 Teeth
- 09.AA 3485 Beer Cilia Forceps
- 10.AA 3565 Berke Ptosis Forceps 20mm
- 11.AA 3600 Snellen Entropium Forceps Left Small
- 12.AA 3605 Snellen Entropium Forceps Right Small
- 13.AA 3615 Ayer Chalazion Forceps

- 14.AA 3620 Lambert Chalazion Forceps
- 15.AA 3790 Mc Pherson Tying Forceps St. Long Handle
- 16.AA 3920 Hartman Mosquito Forceps Straight
- 17.AA 3925 Hartman Mosquito Forceps Curved
- 18.AA 4180 Westcott Stitch Scissors
- 19.AA 4515 Eye Scissors Curved 4 1/2" Length
- 20.AA 4535 Stevens Tenotomy Scissors Curved
- 21.AA 5020 Kalt Needle Holder
- 22.AA 5145 Barraquer N.Holder Short Model M.Jaws,w/o Lock
- 23.AA 5460 Bard-Parker Handle #3 Flat
- 24.AA 3310 Fixation Forceps-2x3 Teeth Angular
- 25.AA 4040 Corneal Scissors

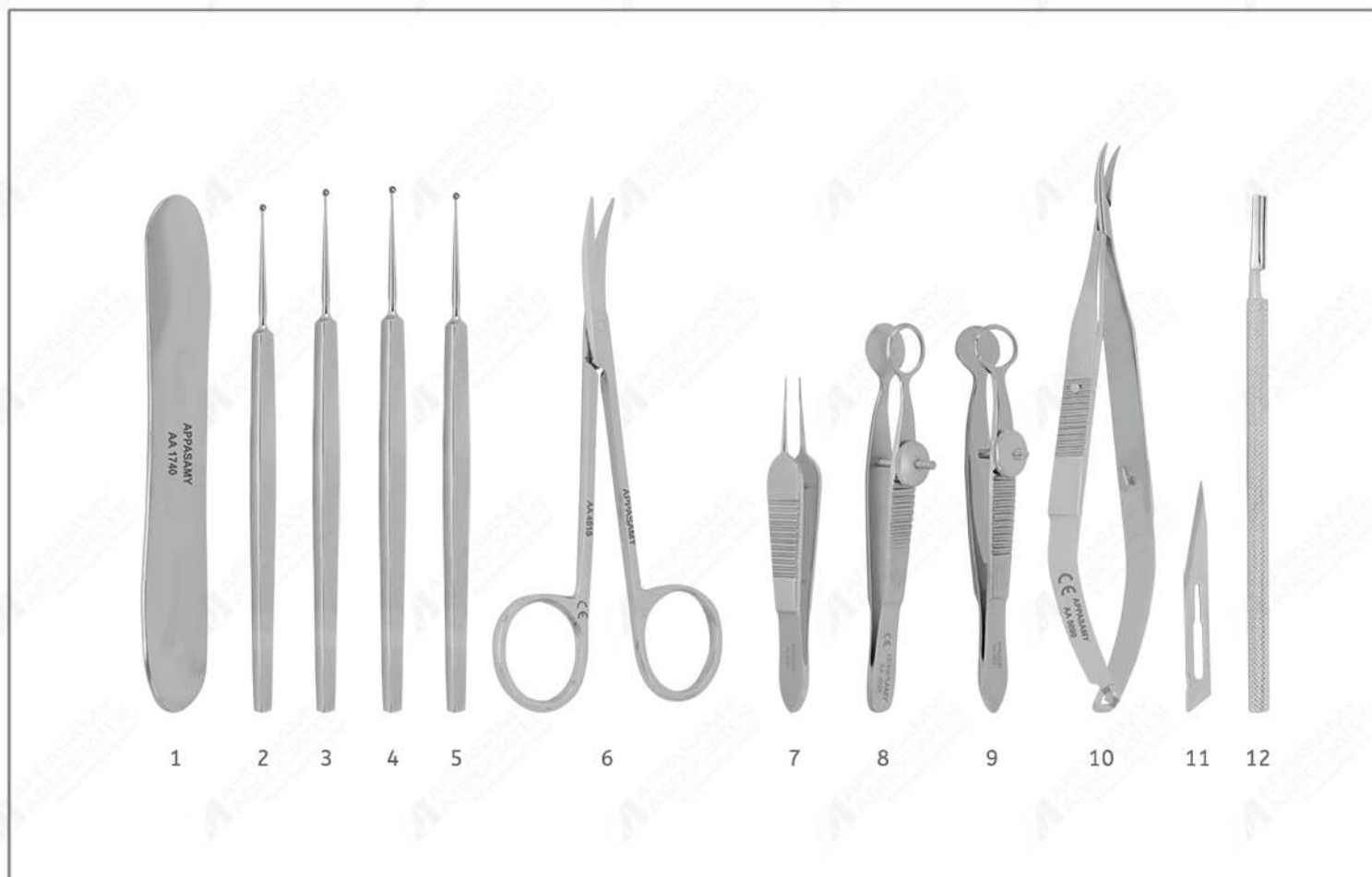

- 01.AA 1740 Jaeger Lid Plate
- 02.AA 1875 Meyerhoefer Chalazion Curette SIZE 0, 1.50mm Dia
- 03.AA 1876 Meyerhoefer Chalazion Curette SIZE 1, 1.75mm Dia
- 04.AA 1877 Meyerhoefer Chalazion Curette Size 2, 2.25mm Dia
- 05.AA 1878 Meyerhoefer Chalazion Curette SIZE 3, 3.0mm Dia
- 06.AA 4515 Eye Scissors Curved 4 1/2" Length
- 07.AA 3275 St. Martin Suturing Forceps 1x2 Teeth
- 08.AA 3630 Hunt Chalazion Forceps, 12mm Dia
- 09.AA 3625 Desmarres Chalazion Forceps 13mm/20mm Dia
- 10.AA 5090 Castroviejo N.Holder Std Jaws Curved With Lock
- 11.AA 5560 Bard-Parker Blade #11, AA 5561 #15
- 12.AA 5465 Bard-Parker Handle #3 Round Handle

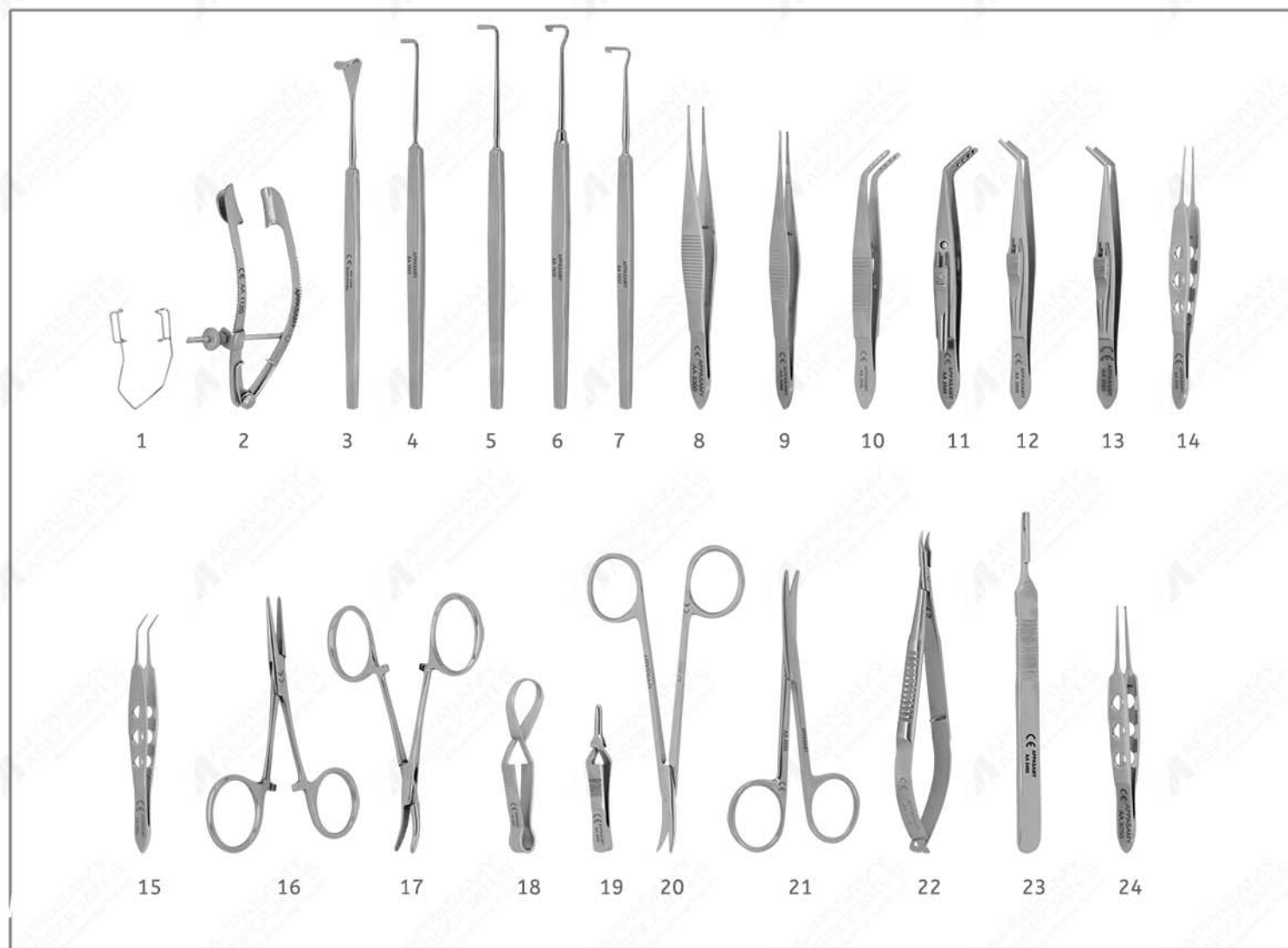

- 01.AA 1009 Barraquer Wire Speculum, Large
- 02.AA 1120 Lancaster Eye Speculum
- 03.AA 1260 Desmarres Lid Retractor Size 0
- 04.AA 1825 Graefe Muscle Hook Size 1
- 05.AA 1826 Graefe Muscle Hook Size 2
- 06.AA 1835 Jameson Muscle Hook Small
- 07.AA 1837 Jameson Muscle Hook Large
- 08.AA 3300 Fixation Forceps 1x2 Teeth
- 09.AA 3460 Wills Hospital Utility Forceps
- 10.AA 3535 Jameson Muscle Forceps Left Child 4 Teeth
- 11.AA 3540 Jameson Muscle Forceps Right Child 4 Teeth
- 12.AA 3555 Worth Advancement Forceps Left
- 13.AA 3560 Worth Advancement Forceps Right

- 14.AA 3790 Mc Pherson Tying Forceps St. Long Handle
- 15.AA 3800 Kelman-Mc Pherson Forceps 7.5mm Angle Long Handle
- 16.AA 3920 Hartman Mosquito Forceps Straight
- 17.AA 3925 Hartman Mosquito Forceps Curved
- 18.AA 3945 Baby Jones Towel Clamp
- 19.AA 3950 Serrefine Small Straight
- 20.AA 4535 Stevens Tenotomy Scissors Curved
- 21.AA 4555 Knapp Strabismus Scissors Curved
- 22.AA 5145 Barraquer N.Holder Short Model M.Jaws, W/o Lock
- 23.AA 5460 Bard-Parker Handle #3
- 24.AA 3255 Bishop-Harmon Tissue Forceps Delicate 0.8mm

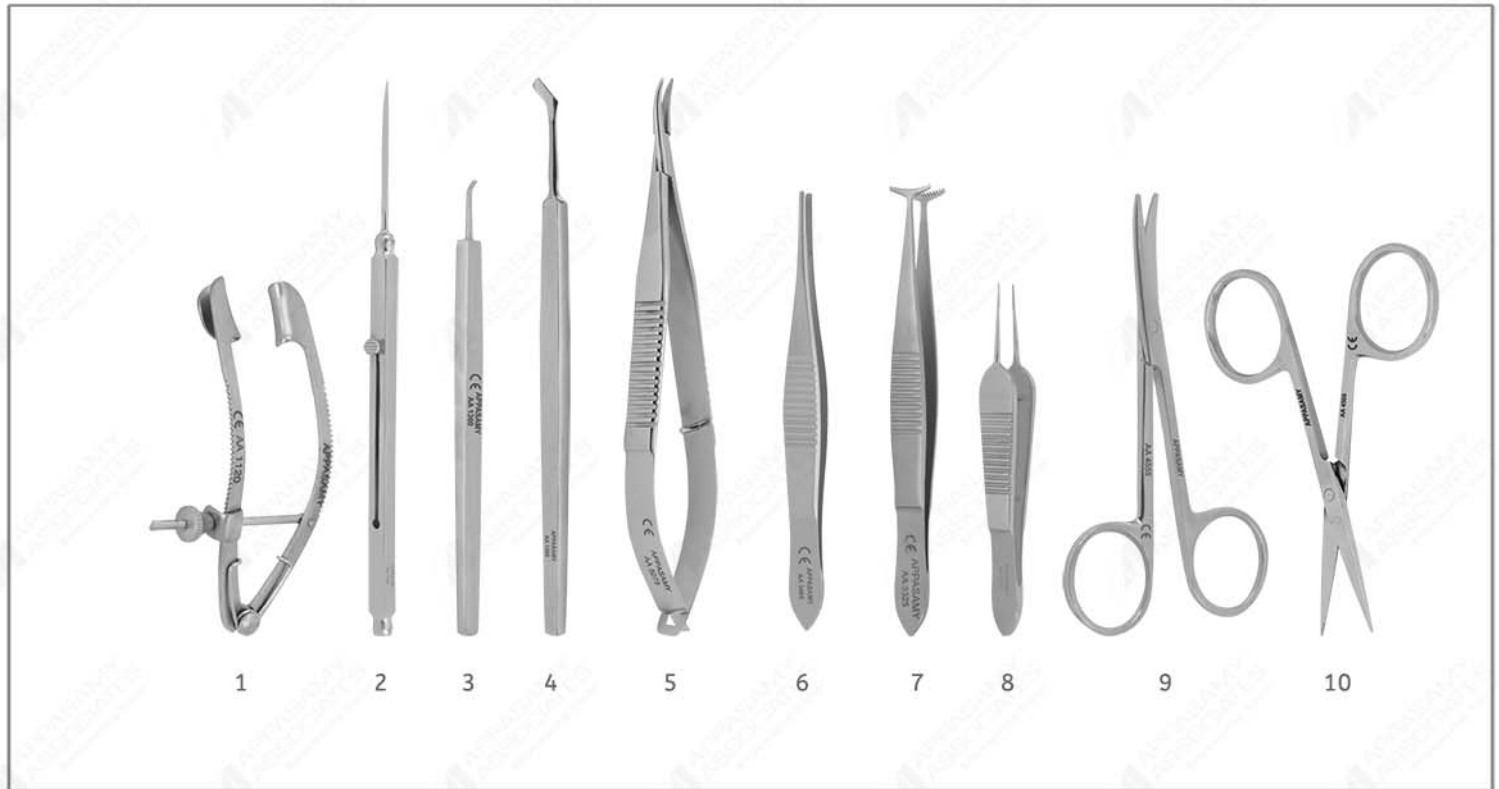

- 01.AA 1120 Lancaster Eye Speculum
- 02.AA 1350 Barraquer Cataract Knife in Sliding Case
- 03.AA 1360 Paufigue Graft Knife
- 04.AA 1390 Paton Corneal Dissector
- 05.AA 5075 Castroviejo N.Holder Deli. Jaws Curved Without Lock
- 06.AA 3465 Bonaccolto Utility Forceps 1.2mm Wide
- 07.AA 3325 Green Fixation Forceps 10mm Wide Jaws
- 08.AA 3275 St. Martin Suturing Forceps 1x2 Teeth
- 09.AA 4555 Knapp Strabismus Scissors Curved
- 10.AA 4500 Iris Scissors Straight 3.5" Length

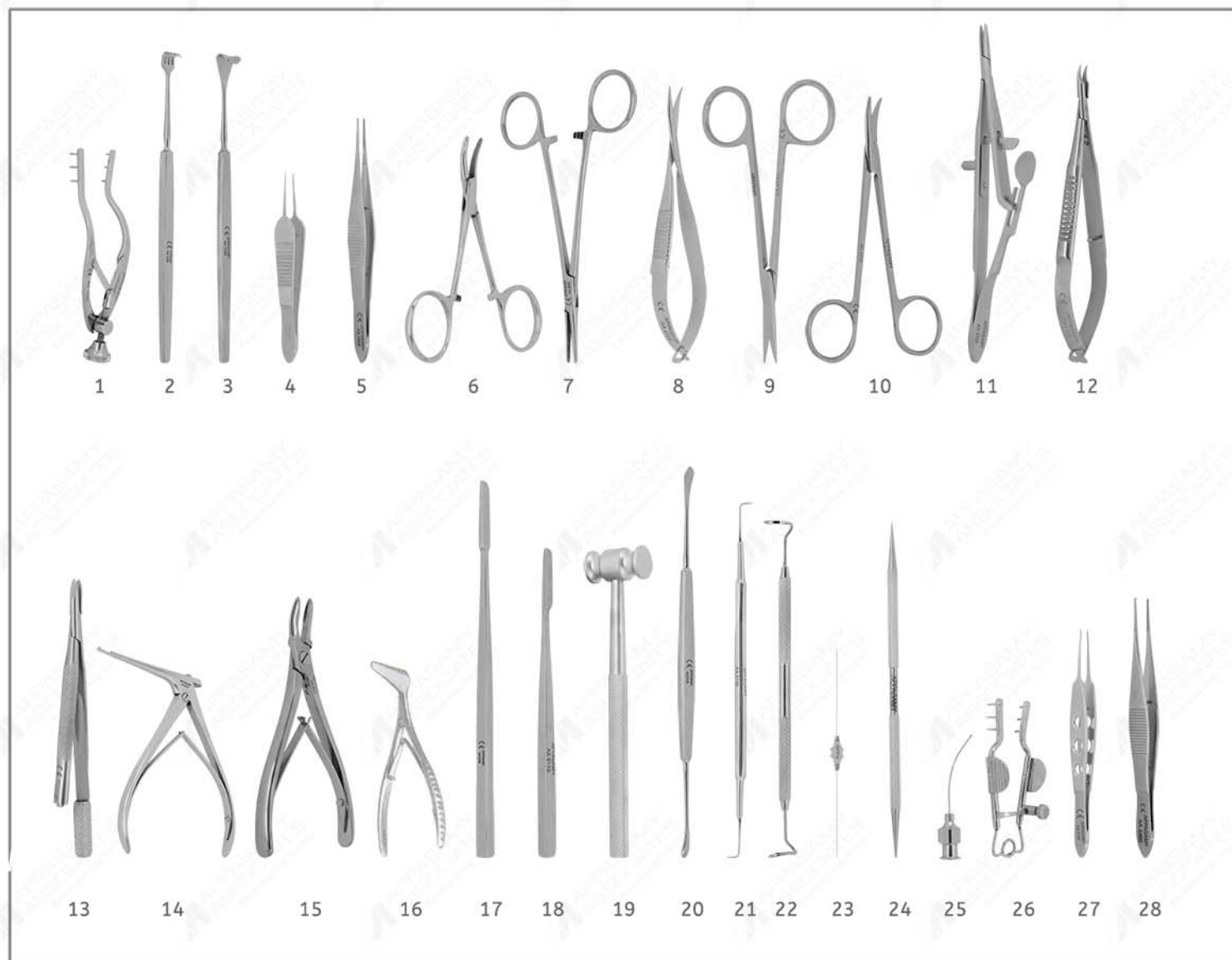

- 01.AA 1200 Stevenson Lacrimal Sac Retractor,3X3 Blunt Prongs
- 02.AA 1220 Knapp Lacrimal Sac Retractor Blunt
- 03.AA 1260 Desmarres Lid Retractor Size 0
- 04.AA 3275 St. Martin Suturing Forceps 1x2 Teeth
- 05.AA 3460 Wills Hospital Utility Forceps
- 06.AA 3925 Hartman Mosquito Forceps Curved
- 07.AA 3930 Halsted Mosquito Forceps Straight
- 08.AA 4180 Westcott Stitch Scissors
- 09.AA 4510 Eye Scissors Straight 4 1/2"Length
- 10.AA 4535 Stevens Tenotomy Scissors Curved
- 11.AA 5020 Kalt Needle Holder Straight
- 12.AA 5145 Barraquer N.Holder Short Model M.jaws,w/o lock
- 13.AA 5405 Castroviejo Blade Breaker and Holder,Big
- 14.AA 6010 Kerrison Bone Nibbling Ronguer Size 0
- 15.AA 6030 Beyer Bone Nibbling Ronguer Single Action

- 16.AA 6040 Nasal Speculum Infant
- 17.AA 6100 West Lacrimal Chisel Straight
- 18.AA 6110 West Bone Gauge
- 19.AA 6120 Mallet For DCR
- 20.AA 6130 Freer Periosteal Elevator
- 21.AA 6140 Traquair Periosteal Elevator
- 22.AA 6150 Pigtail Probe With Suture Holes
- 23.AA 6175 Bowman Lacrimal Probe, Malleable Stainless Steel
- 24.AA 6440 Castroviejo Lacrimal Dilator (Double end)
- 25.AA 7040 West Lacrimal Cannula Blunt Tip With Side Port
- 26.AA 1185 Mueller Lacrimal Sac Retractor
- 27.AA 3790 Mc Pherson Tying Forceps St. Long Handle
- 28.AA 3300 Fixation Forceps 1x2 Teeth

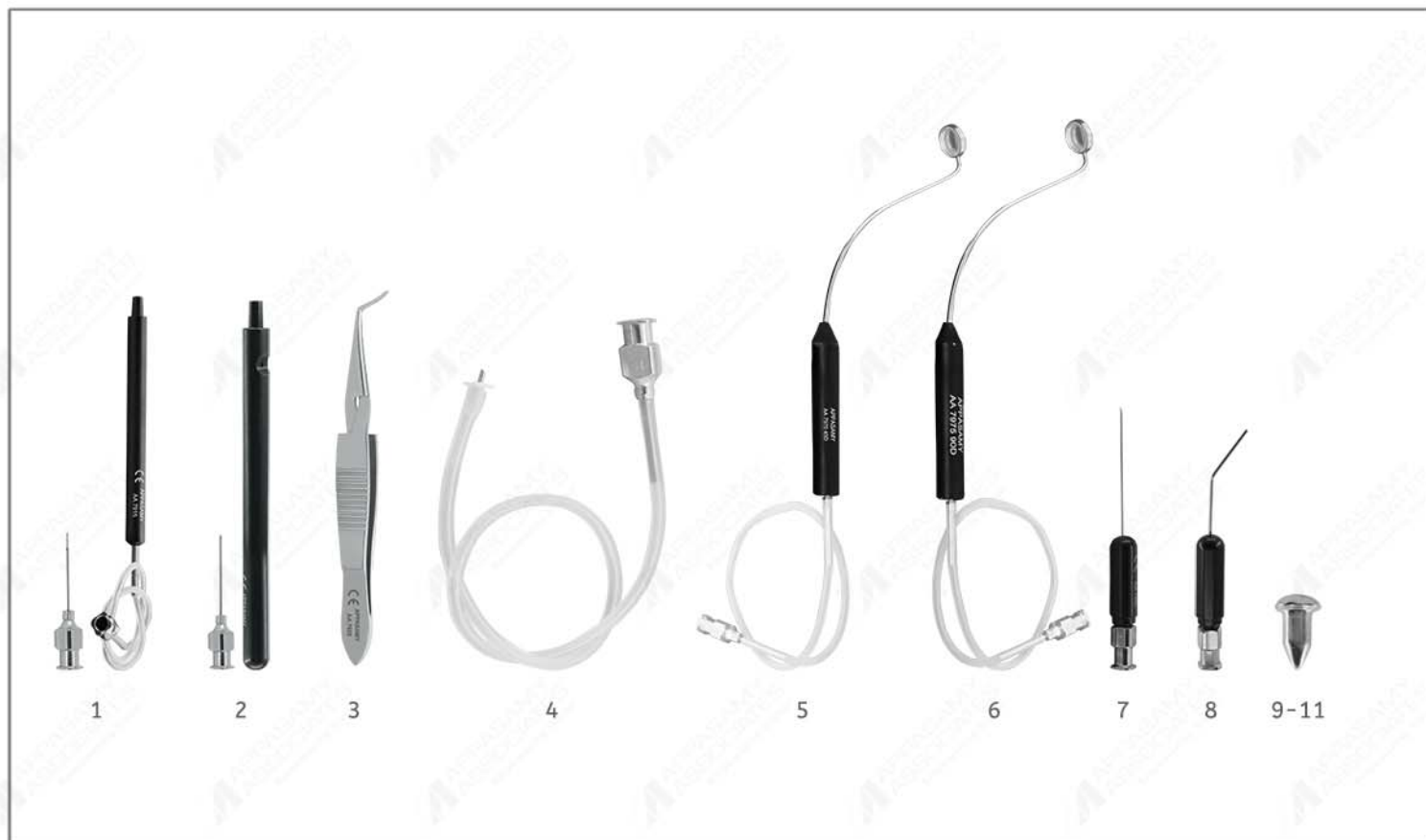

- 01.AA 7915 Tapered Extrusion Handpiece Cannula
- 02.AA 7920 Charles Flute Needle Cannula
- 03.AA 7925 Scleral Plug Holding Forceps
- 04.AA 7960 Scleral Plug Holding Forceps
- 05.AA 7970 45 Diaptor Irrigating Contact Lens
- 06.AA 7975 90 Diaptor Irrigating Contact Lens
- 07.AA 7980 Membrane Peeler
- 08.AA 7985 May 30° Bent Needle
- 09.AA 7950 Scleral Plugs
- 10.AA 7951 Scleral Plugs
- 11.AA 7952 Scleral Plugs

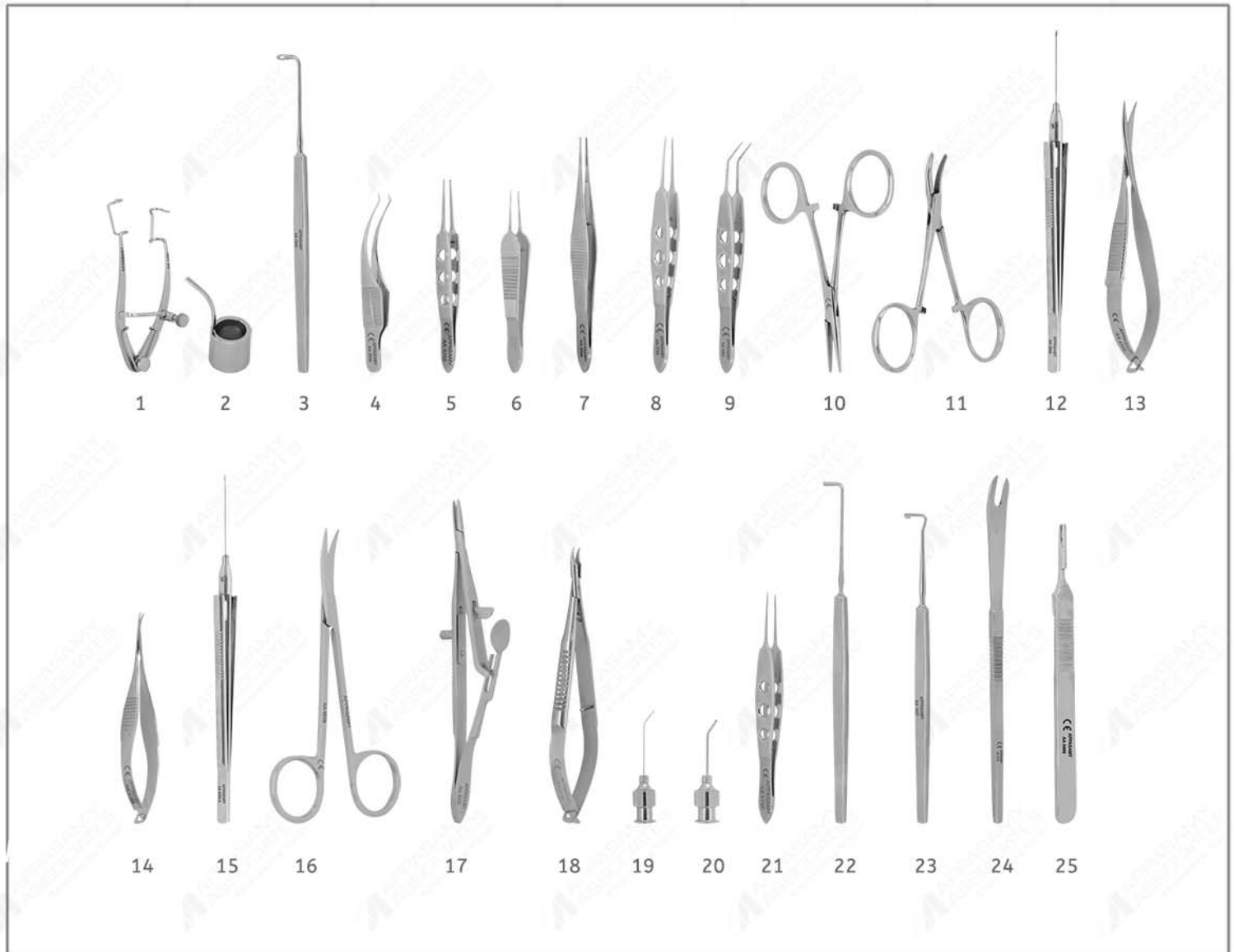

- | | |
|--|--|
| 01.AA 1090 Clark Eye Speculum Small | 14.AA 4255 Vannas Capsulotomy Scissors (Curved) |
| 02.AA 1300 Schepens Scleral Depressor Small #8 | 15.AA 4450 Vitreous Scissors 20G Straight |
| 03.AA 1830 Gass Retinal Detachment Hook | 16.AA 4515 Eye Scissors Curved 4 1/2" Length |
| 04.AA 3030 Barraquer Colibri Forceps 1x2 Teeth 0.12mm | 17.AA 5020 Kalt Needle Holder Straight |
| 05.AA 3255 Bishop-Harmon Tissue Forceps Delicate 0.8mm | 18.AA 5145 Barraquer N.Holder Short Model Micro Jaws, W/o Lock |
| 06.AA 3275 St. Martin Suturing Forceps 1x2 teeth teeth | 19.AA 7107 Rycroft Air injection Cannula 27G |
| 07.AA 3460 Westcott Stitch Scissors | 20.AA 7135 Bishop Harmon Anterior Champer Cannula 19G |
| 08.AA 3790 Mc Pherson Tying Forceps Straight Long Handle | 21.AA 3150 McPherson Corneal Forceps |
| 09.AA 3805 Mc Pherson Forceps 11mm Angled | 22.AA 1827 Graefe Muscle Hook Size 3 |
| 10.AA 3920 Hartman Mosquito Forceps Straight | 23.AA 1837 Jameson Muscle Hook Large |
| 11.AA 3925 Hartman Mosquito Forceps Curved | 24.AA 1270 Schepens Forked Orbital Retractor |
| 12.AA 3960 Vitreous Forceps 20G Smooth Jaws, straight | 25.AA 5460 Bard- Parker Handle #3 Flat |
| 13.AA 4180 Westcott Stitch Scissors | |

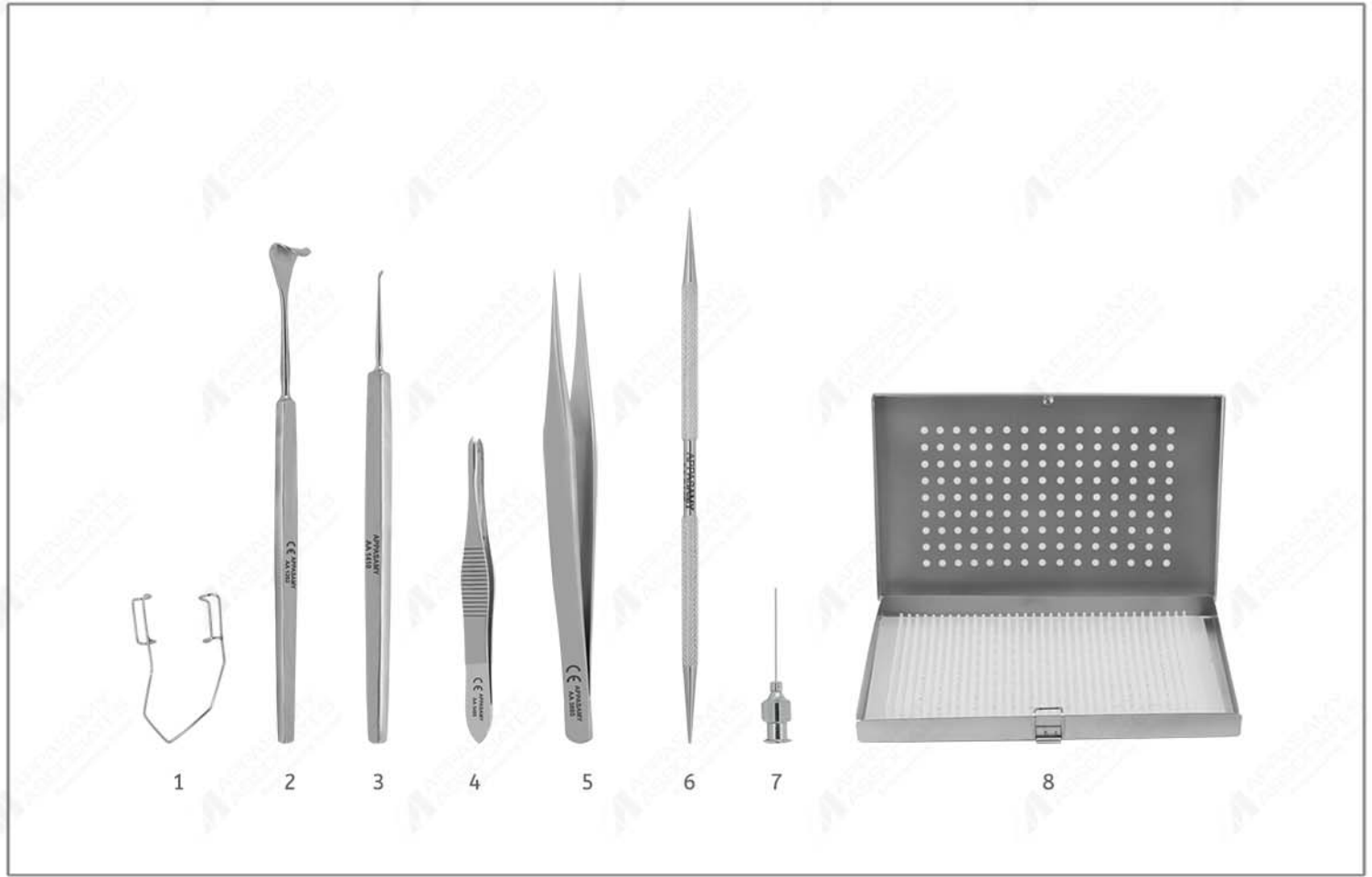

- 01.AA 1009 Barraquer Wire Speculum, Big
- 02.AA 1262 Desmarres Lid Retractor Size 2
- 03.AA 1410 Golf Club Foreign Body Spud
- 04.AA 3485 Beer Cilia Forceps
- 05.AA 3885 Jewelers Forceps Standard
- 06.AA 6440 Castroviejo Lacrimal Dialator (Double end)
- 07.AA 7010 Lacrimal Cannula, 23G , Straight
- 08.AA 8005 Appasamy Sterilization Box, Complete

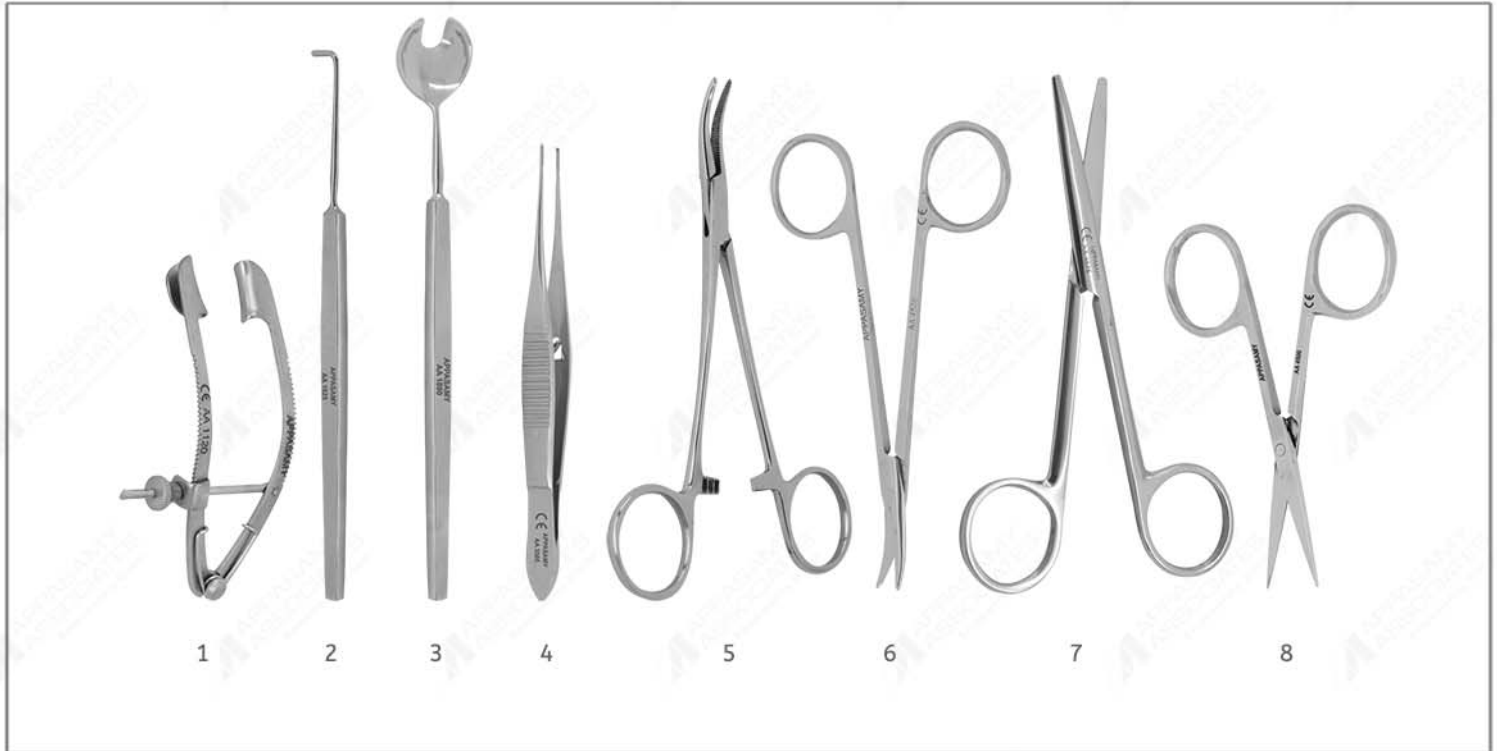

1. AA 1120 Lancaster Eye Speculum
2. AA 1825 / AAT 1825 Graefe Muscle Hook Size 1
3. AA 1890 Wells Enucleation Spoon
4. AA 3305 Elschmig Fixation Forceps 1x2 Angled Teeth
5. AA 3935 / AAT 3935 Halsted Mosquito Forceps Curved
6. AA 4535 Stevens Tenotomy Scissors Curved
7. AA 4575 Enucleation Scissors (St)
8. AA 4500 Eye Scissors, Straight

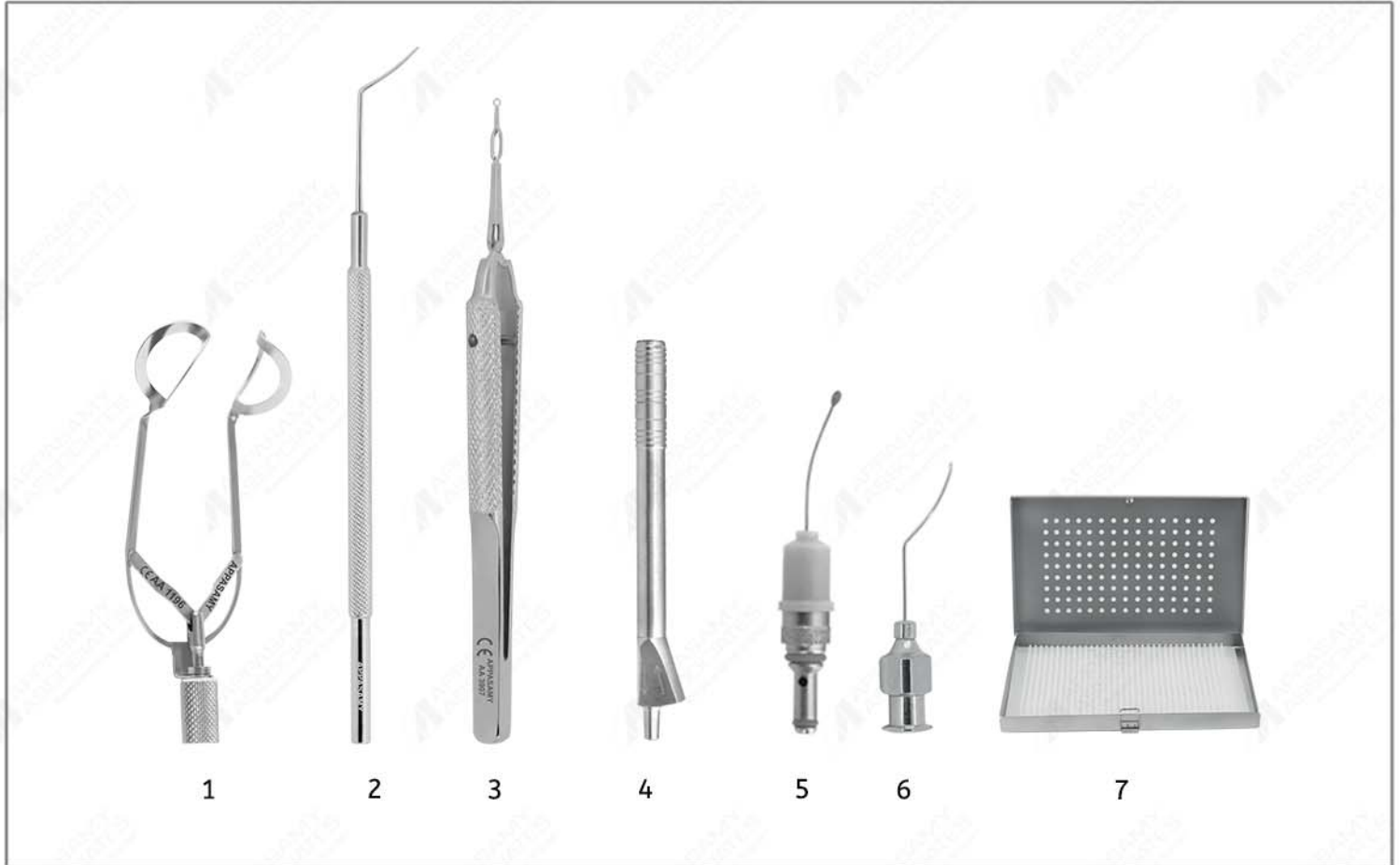

1. **AA 1196** Jerome Bovert Speculum Reversible
2. **AA/AAT 1666** Slade Femtosecond Spatula
3. **AA/AAT 3907** Nucleus Divider
4. **AA 7393** I/A Hand Piece
5. **AA 7398** I/A Tip
6. **AA 7222** Slade Femtosecond Cannula
7. **AA 8005** Sterilization Box



1. **AA/AAT 1398** Corneal Dissector, Straight Blade
2. **AA/AAT 1399** Corneal Dissector, Vaulted Blade
3. **AA/AAT 1696** Busan Endothelial Glide
4. **AA 2030** See Through CornealTrepine 8.5mm
5. **AA 2031** See Through CornealTrepine 9.0mm
6. **AA 2032** See Through CornealTrepine 9.5mm
7. **AA 2065** Corneal Transplant Punch
8. **AA 2249** Bores Optic Zone Marker, 9.0mm
9. **AA 2500** Dseak Glider
10. **AA 2505** Dseak Stromal Scrubber
11. **AA 2510** Dseak Descement's Stripper
12. **AA 2515** Reverse Sinskey Hook
13. **AA 2530** Rosenwasser Lamellar Donor Inserting Shovel
14. **AA 3731** Donor Lamellar Inserting Forceps
15. **AA 3990** DSEAK Grasping Forceps, 23G
16. **AA 7150** Lewicky A/C Maintainer
17. **AA 8020** Stainless Steel Box
18. **AAT 8325** Rosenwasser Irrigating Endothelial Stripper

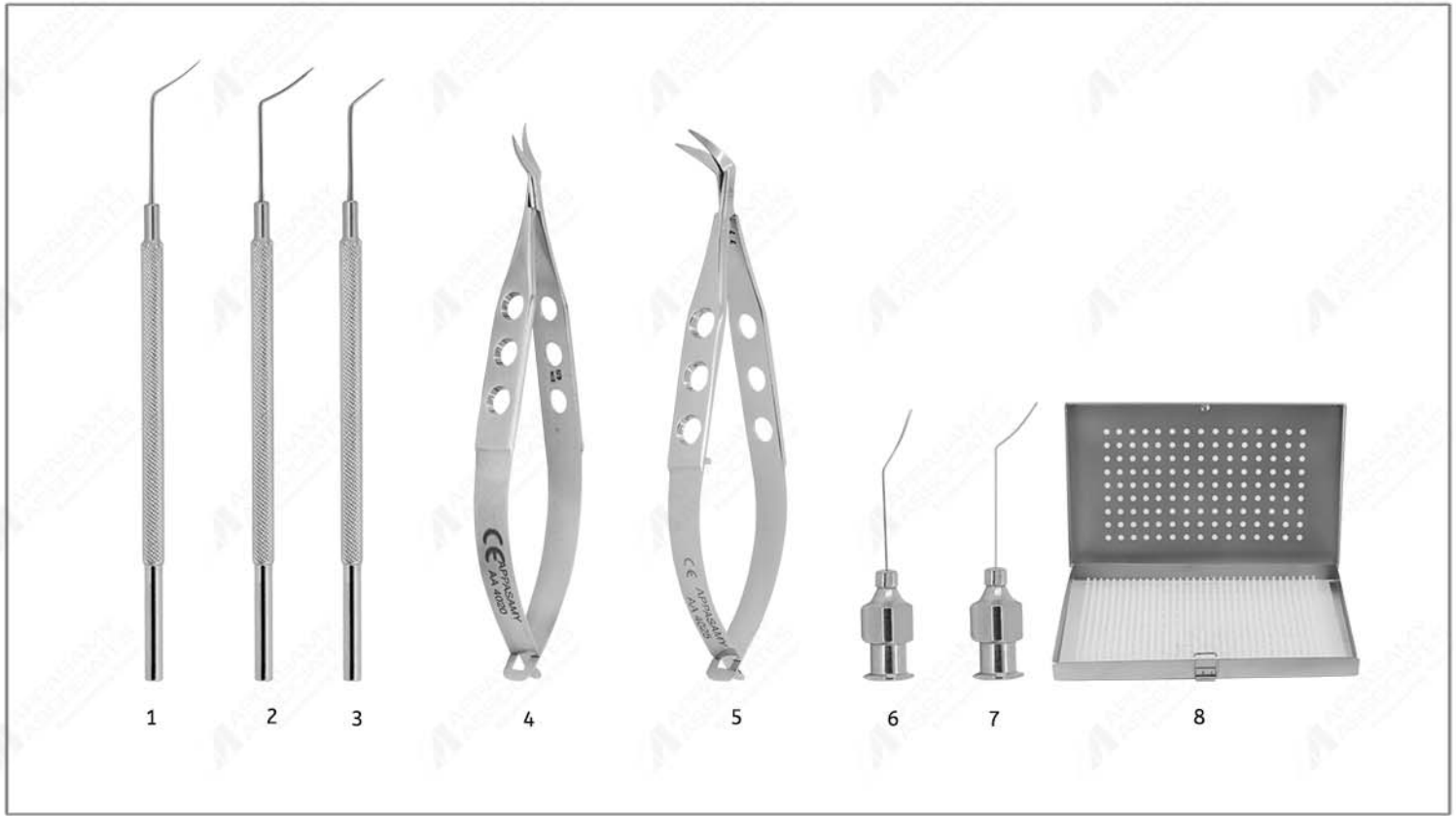

1. **AA/AAT 2555** DALK Corneal Dissector
2. **AA/AAT 2560** Rosenwasser DALK Trisector
3. **AA/AAT 2565** Bonfadini DALK Spatula
4. **AA 4020** Katzin Corneal Transplant Scissors, Right
5. **AA 4025** Katzin Corneal Transplant Scissors, Left
6. **AA 7050** Rosenwasser DALK Cannula
7. **AA 7100** DALK Air Injection Cannula
8. **AA 8005** Instruments Case, Small

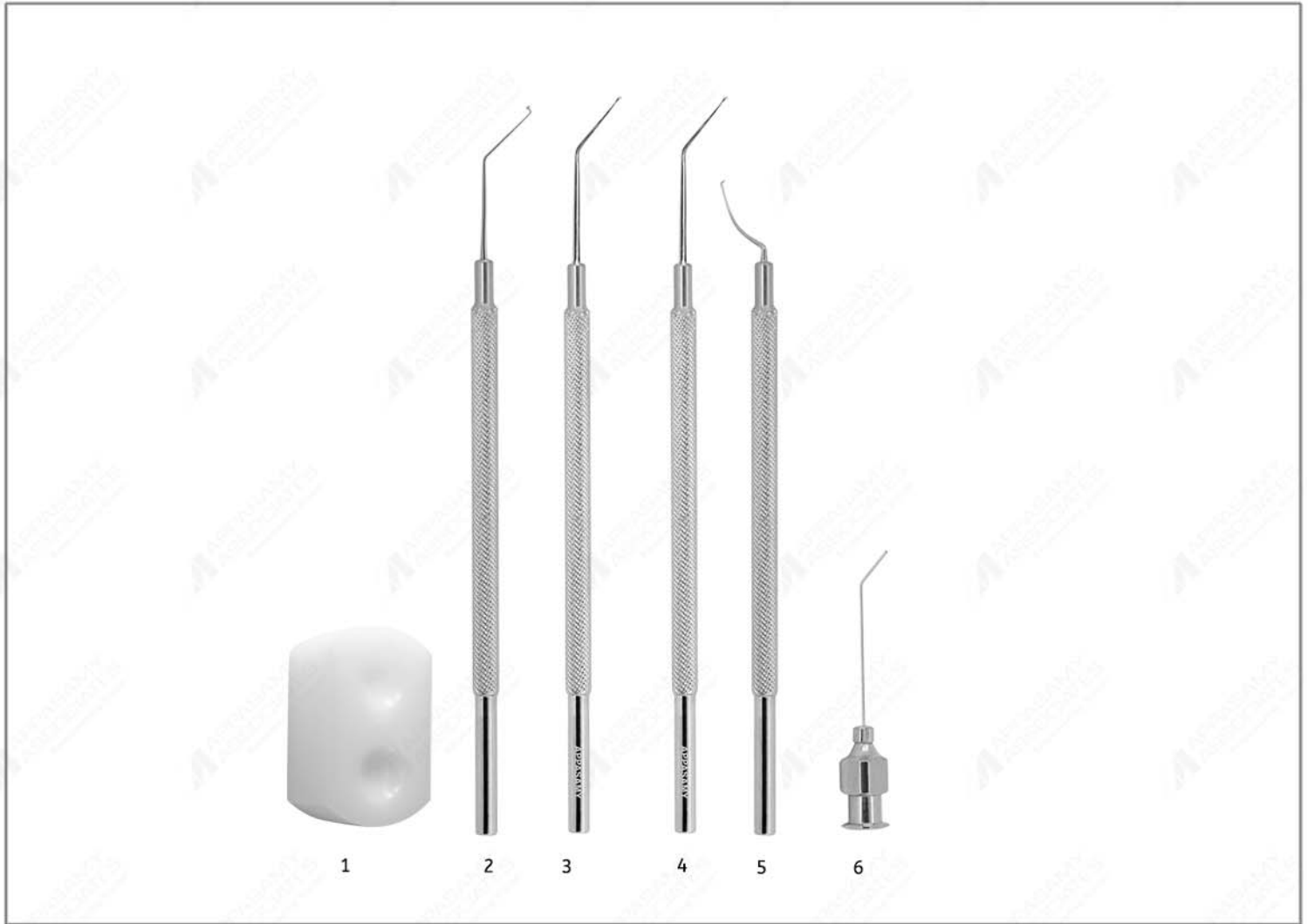

1. **AA 2062** DMEK Twin Block
2. **AA/AAT 2535** DMEK Rake
3. **AA 2540** DMEK Large Crystal Spatula
4. **AA 2545** DMEK Small Crystal Spatula
5. **AA 2550** Dexatome DMEK/DSA EK Spatula
6. **AA 7116** DMEK Cannula

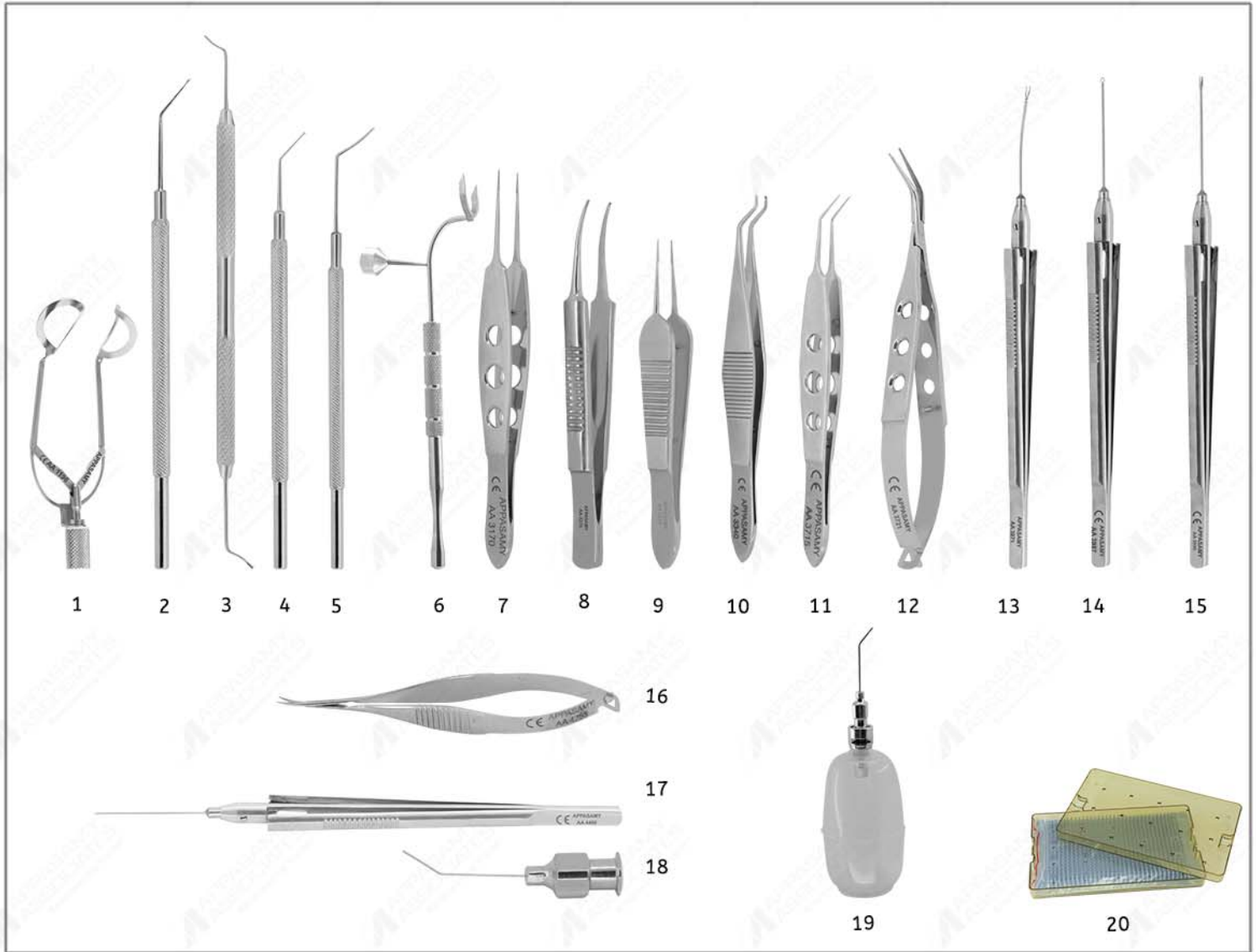

- | | |
|------------------------|---|
| 1. AAT 1196 | Jerome Bovert Speculum Reversible |
| 2. AA/AAT 1478 | Toric Lens Manipulator |
| 3. AA/AAT 1481 | Zaldivar Lens Manipulator |
| 4. AA/AAT 1613 | Pisacano Hook Horizontal |
| 5. AA/AAT 1655 | Barrquer Iris Spatuls, Angled. |
| 6. AA/AAT 2800 | LRI Axis Marker |
| 7. AA/AAT 3170 | Bonn Corneal Forceps |
| 8. AA 3270 | Iris Forceps |
| 9. AA/AAT 3275 | Paufique Suturing Forceps |
| 10. AA 3340 | Dastoor Suturing Rectus Forceps |
| 11. AA 3715 | Lens Removal Forceps |
| 12. AA 3721 | Loading Forceps |
| 13. AA/AAT 3871 | Iridectomy Forceps |
| 14. AA/AAT 3987 | Cartridge Forceps |
| 15. AA/AAT 3990 | Zaldivar Iridectomy Forceps |
| 16. AA/AAT 4255 | Vannas Capsulotomy Scissors, Curved |
| 17. AA 4460 | Iridectomy Scissors |
| 18. AA 7207 | Pearce Hydro dissection Cannula, 35° Angled 27G |
| 19. AA 7830 | Silicone Bulb with Adaptor |
| 20. AA 8200 | Plastic Sterilizing Tray with Silicon Mat |

AA - Stainless Steel, AAT - Titanium, AAD - Disposable Instruments

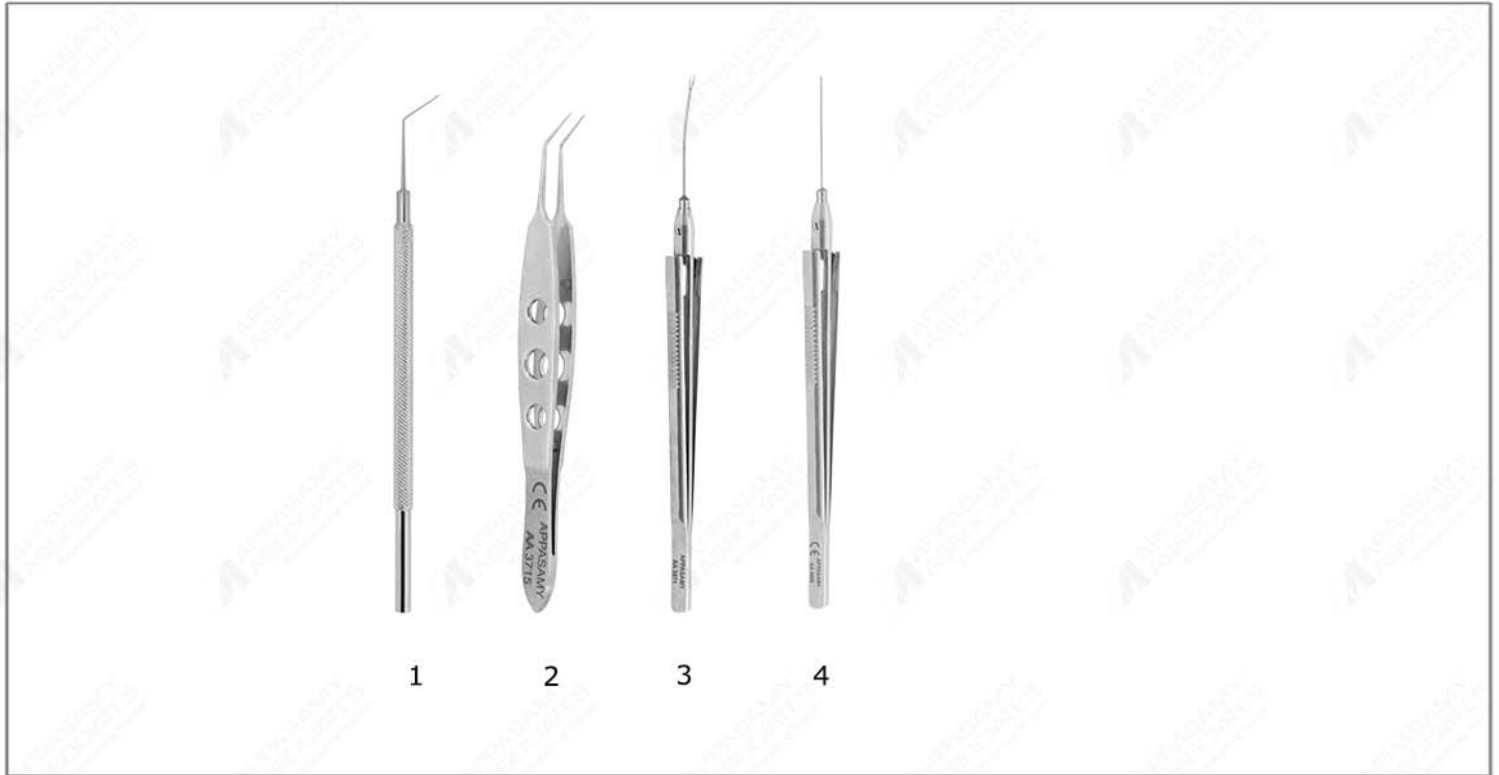

- 01.AA 1485 Hook
- 02.AA 3715 Lens Holding Forceps
- 03.AA/AAT 3871 Iridectomy Forceps
- 04.AA 4460 Iridectomy Scissors

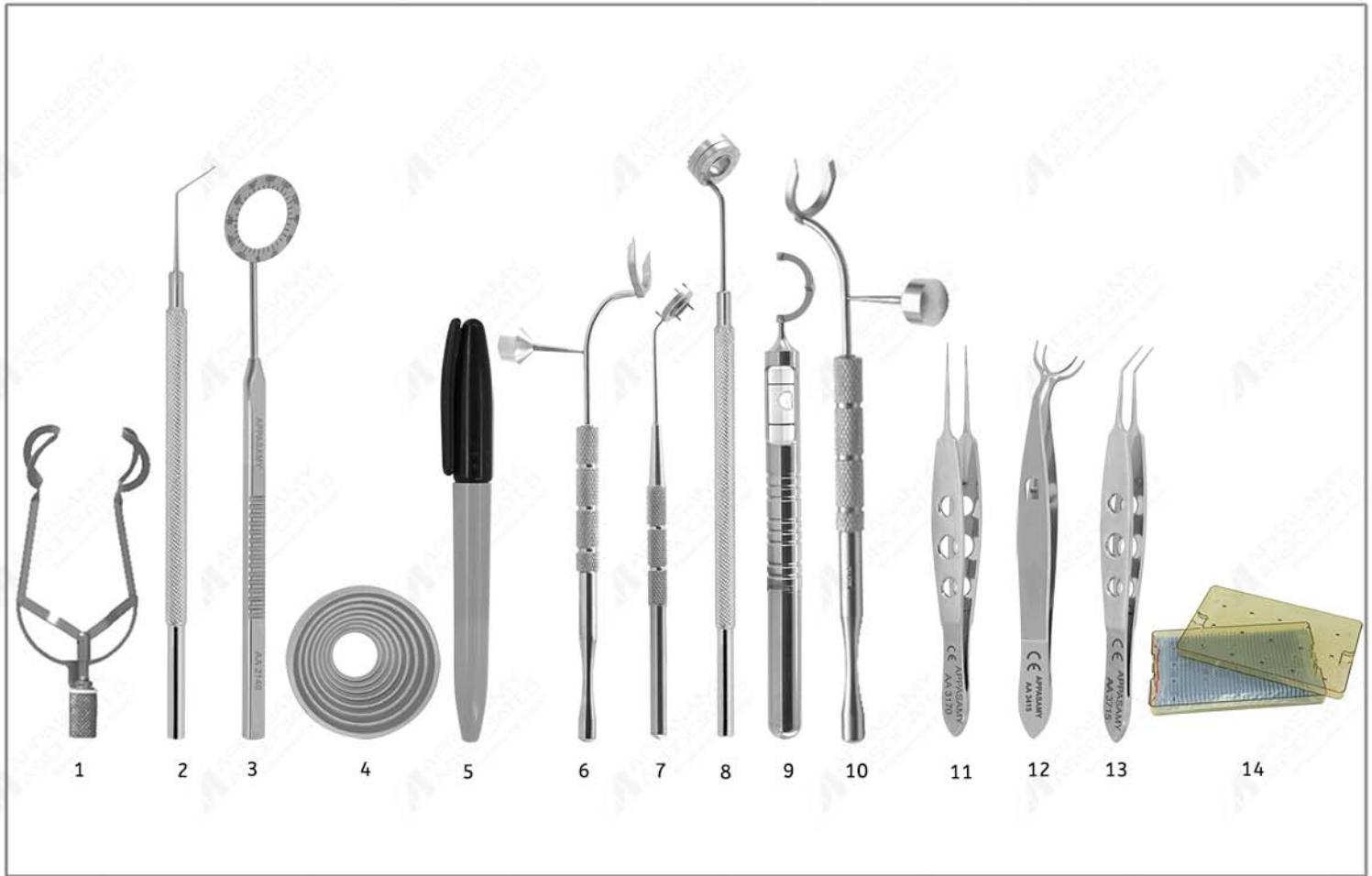

- | | | |
|-----|--------------------|---|
| 1. | AAT 1196 | Jerome Bovert Speculum Reversible |
| 2. | AA 1485 | Hook / Manipulator |
| 3. | AA 2140 | Limbal Relaxing Incision (LRI) Gauge |
| 4. | AA/AAT 2183 | Keratometer |
| 5. | AA 2300 | Marking Pen |
| 6. | AA 2800 | LRI Axis Marker |
| 7. | AA 2820 | LRI Marker, 6mm & 8mm Chord Lengths |
| 8. | AA 2825 | LRI Marker, 40-60-80 degree |
| 9. | AA 2830 | Pre-Op Toric Reference Marker With Bubble Level |
| 10. | AA 2840 | LRI Slit Lamp Marker |
| 11. | AA/AAT 3170 | Bonn Corneal Forceps |
| 12. | AA 3415 | Fixation Forceps |
| 13. | AA 3715 | Lens Holding Forceps |
| 14. | AA 8200 | Plastic Sterilizing Tray With Silicone Mat |

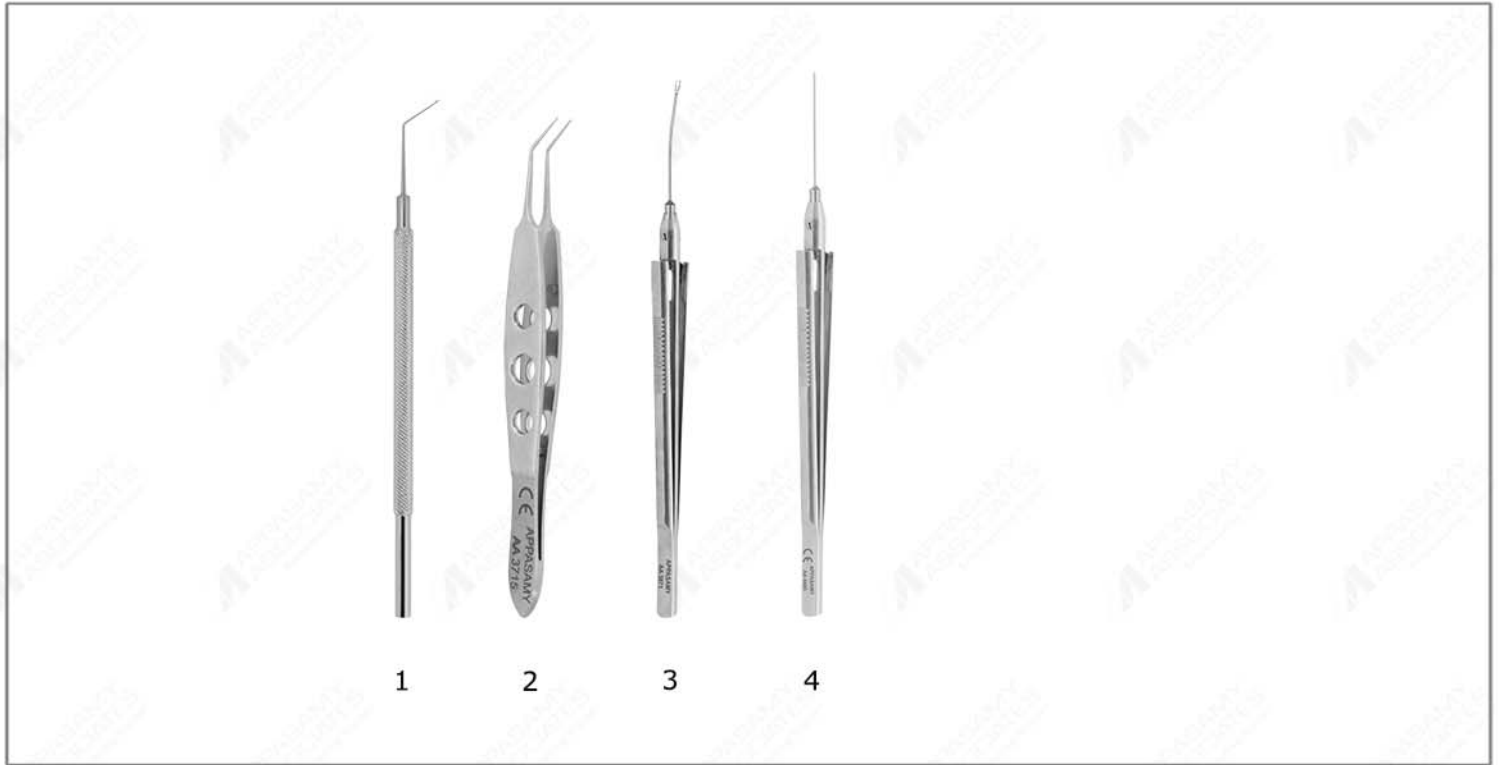

- 01.AA 1485 Hook
- 02.AA 3715 Lens Holding Forceps
- 03.AA/AAT 3871 Iridectomy Forceps
- 04.AA 4460 Iridectomy Scissors

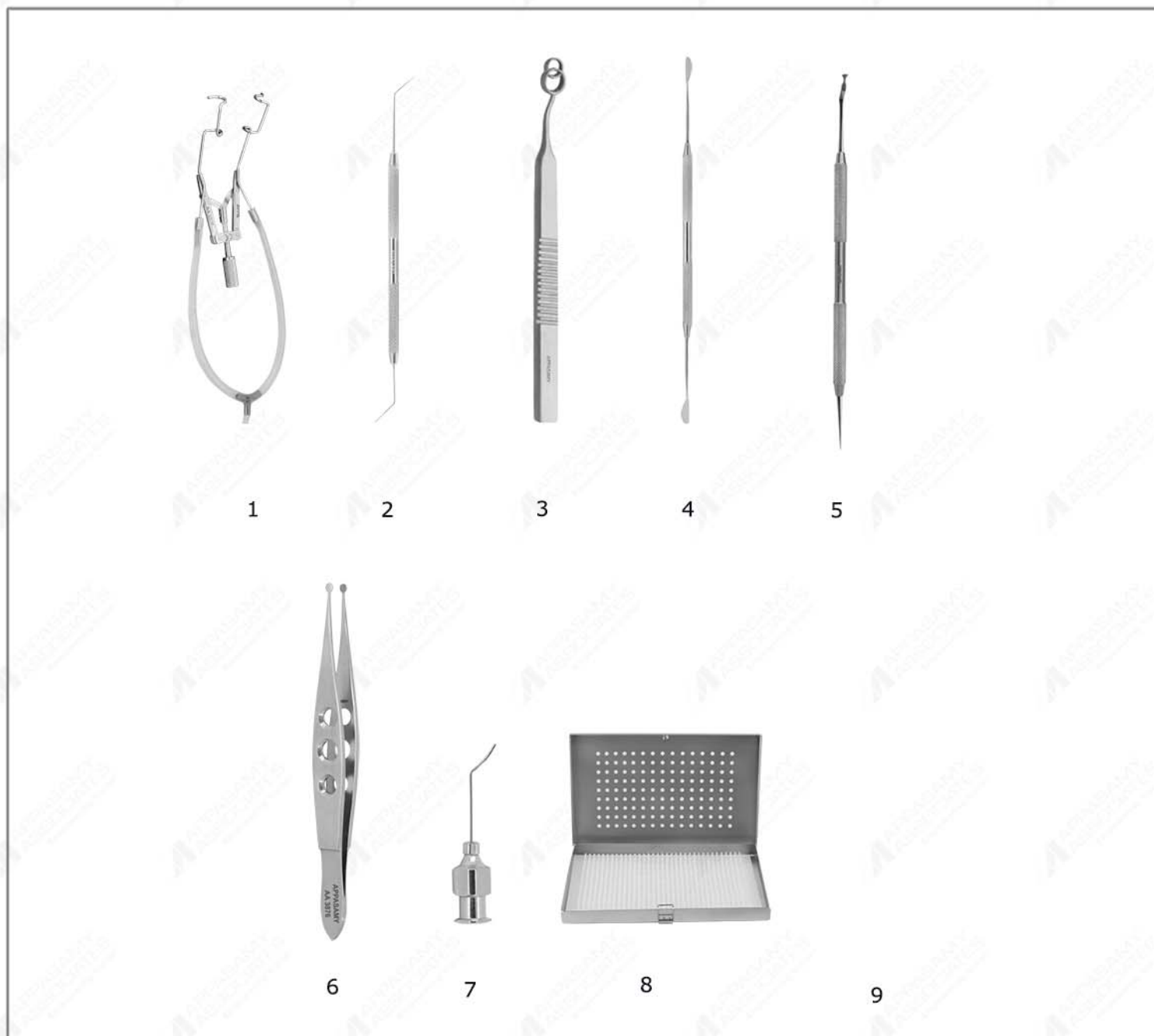

- 01.AA 1086 Thorlakson Aspirating Speculam
- 02.AA/AAT 1639 ASIK Flap Lifter
- 03.AA 2157 Corneal Marker
- 04.AA 2625 Buratto LASIK Flap Protector
- 05.AA/AAT 2650 Thorlakson Z - LASIK Flap Lifter
- 06.AA 3876 Buratto LASIK Flap Forceps
- 07.AA 7885 Buratto LASIK Cannula 23G
- 08.AA 8005 Instrument Case, Small
- 09.AA 9180 Sponge

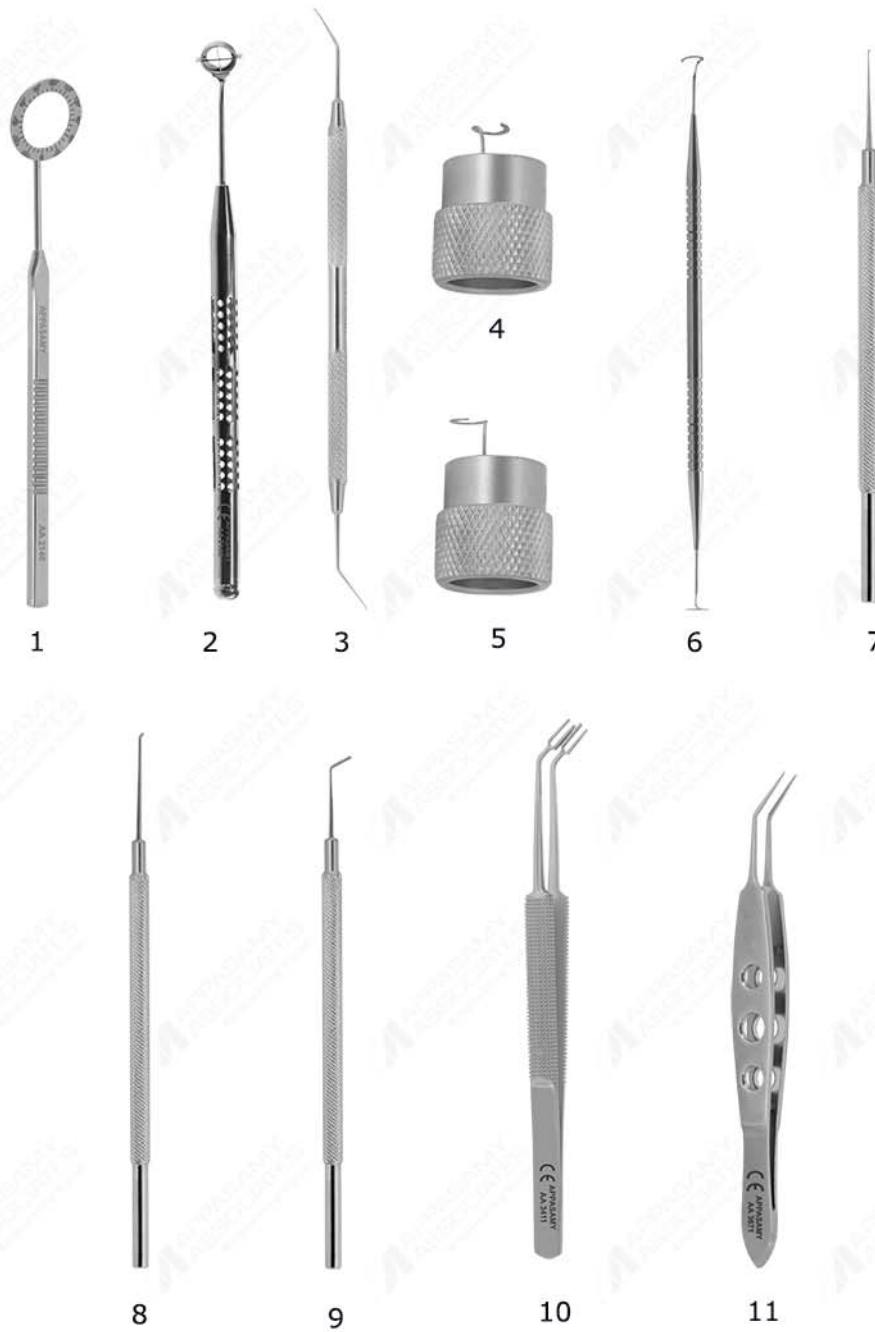

- 01.AA 2140 Marker Degree Geuge Toker Piece
- 02.AA/AAT 2146 Toric IOL Marker
- 03.AA/AAT 2221 Optical Zone Marker
- 04.AA 2432 ICSR Tunnel Marker Left
- 05.AA 2433 ICSR Tunnel Marker Right
- 06.AA 2434 ICSR Tunnel Marker Double Ended
- 07.AA/AAT 2516 Flevator Far ICSR Implantation
- 08.AA/AAT 2517 SUAREZ SPREADER
- 09.AA/AAT 2518 Bicalto Guide
- 10.AA 3411 Nevyes wallace Fixation
- 11.AA 3671 Forceps For ICSR Implant

AA - Stainless Steel, AAT - Titanium, AAD - Disposable Instruments

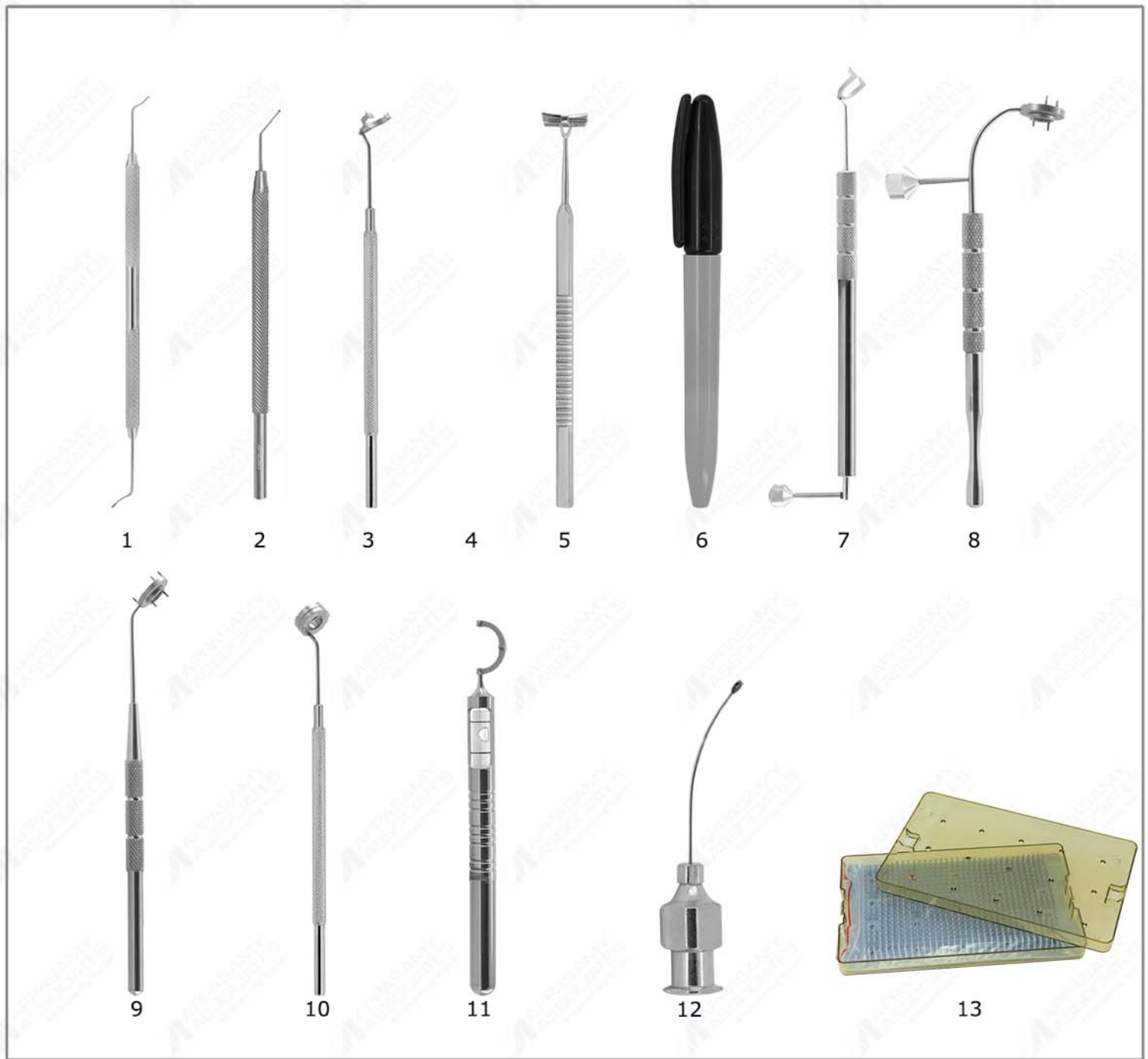

- 01.AA 1481 ZALDIVER LENS NANIPULATOR DOUBLE ENDED
- 02.AA/AAT 1482 Pallikaris Lens Manipulator
- 03.AA/AAT 2286 Henderson Alignment Marker
- 04.AA/AAT 2287 Henderson Degree Gauge
- 05.AA/AAT 2288 Henderson Toric IOL Marker
- 06.AA 2300 Marking Pen, Fine Tip
- 07.AA 2805 White House Graving Axis Marker II
- 08.AA 2815 TORIC COMBO MARKER
- 09.AA/AAT 2820 LRI Marker 6 & 8mm Chord Length
- 10.AA/AAT 2825 LRI Marker 40-60-80 Degree
- 11.AA 2830 Pre-Op Toric Reference Marker, With Bubble Level
- 12.AA 7621 Henderson MICS Capsule Polisher
- 13.AA 8200 Plastic Sterilization Tray With Silicone Mat

AA - Stainless Steel, AAT - Titanium, AAD - Disposable Instruments

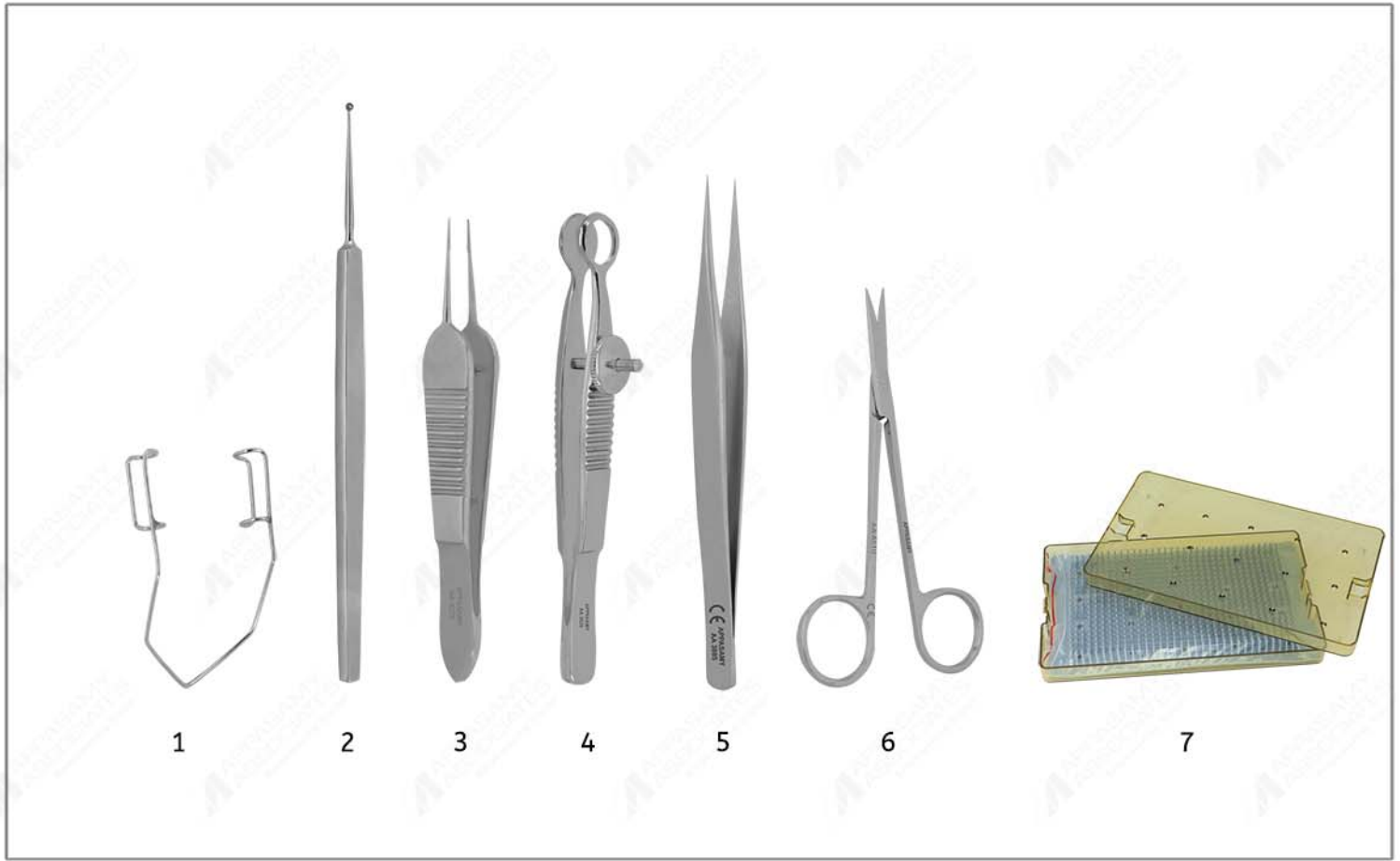

1. **AA 1009** Barraquer Wire Speculum, Large
2. **AA 1875** Meyerhoefer Chalazion Curette, Size 0
3. **AA 3275** St. Martin Suturing Forceps
4. **AA 3620** Lambert Chalazion Forceps
5. **AA 3885** Jewelers Forceps
6. **AA 4510** Eye Scissors, 4.5" Length
7. **AA 8200** Appasamy Plastic Sterilization Box

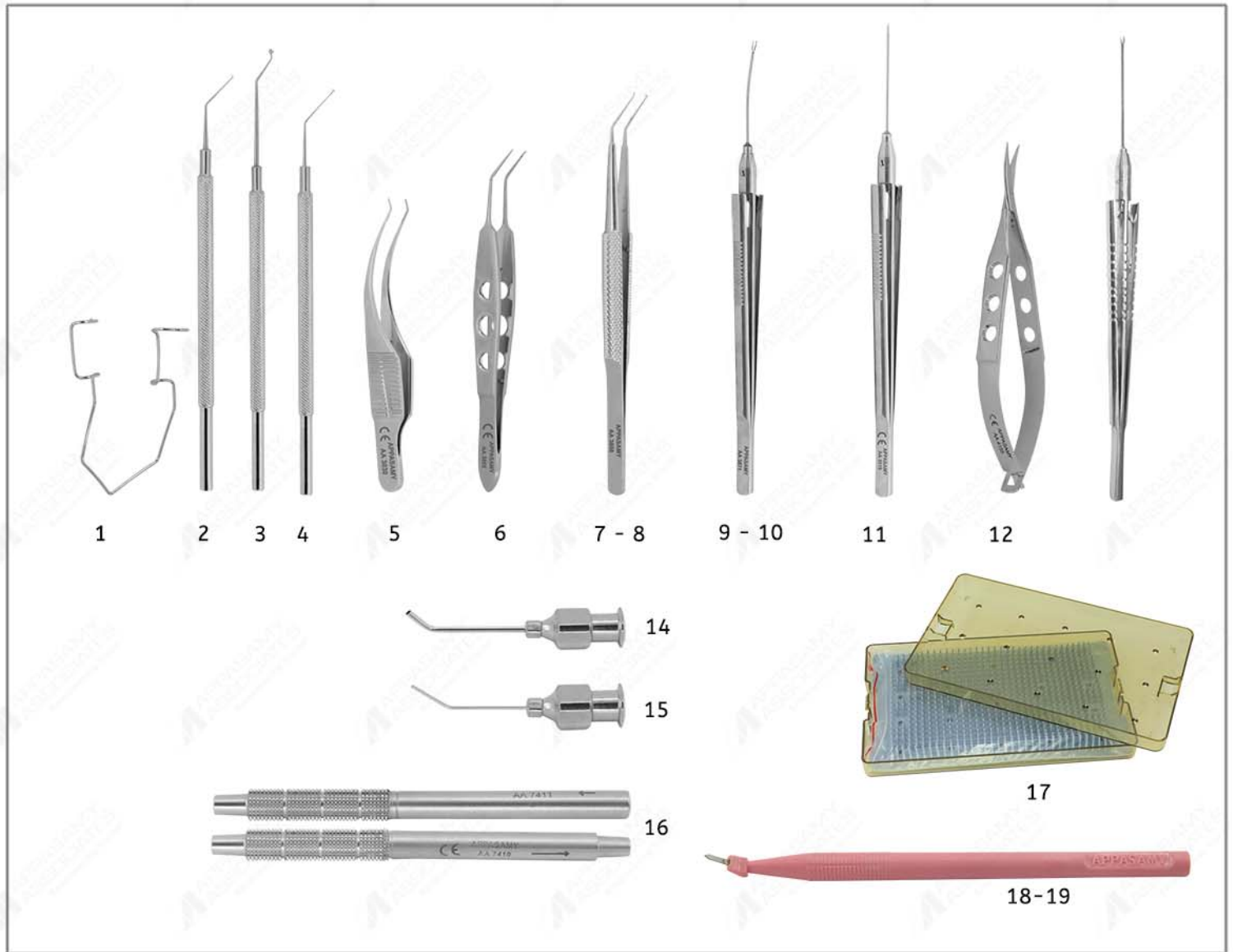

1. AA/AAT 1025 Kratz-Barrquer Wire Speculum, Big
2. AA 1465 Sinsky II Lens Manipulating Hook
3. AA 1597A Akahoshi Nucleus Ring Sustainer
4. AA 1993 Agarwal Phaco Chopper, 1mm
5. AA 3030 Barraquer Colibri Forceps
6. AA 3805 Mc Pherson IOL Forceps
7. AA 3868 Utrata Capsulorhexis Forceps, Round Handle, Extra Delicate
8. AA 3869 Masket Capsulorhexis Forceps, Round Handle, Extra Delicate
9. AA 3871 Kreshner Micro Incision, 20G
10. AA 3872 Kreshner Micro Incision, 23G
11. AA 3918 Akahoshi Super Combo Prechopper
12. AA 4155 Westcott Tenotomy Scissors
13. AA 4461 Alio MICS Scissors, 23g
14. AA 7105 Rycroft Air Injection Cannula, 23G
15. AA 7205 Pearce Hydrodissection Cannula, 25G
16. AAT 7410/11 Appasamy Aspirating / Irrigating Handle, 23G
17. AA 8200 Appasamy Plastic Sterilization Box
18. AA 572014 Ultra Thin Phaconit Blade, 1.4mm
19. AA 572018 Ultra Thin Phaconit Blade, 1.8mm

AA - Stainless Steel, AAT - Titanium, AAD - Disposable Instruments

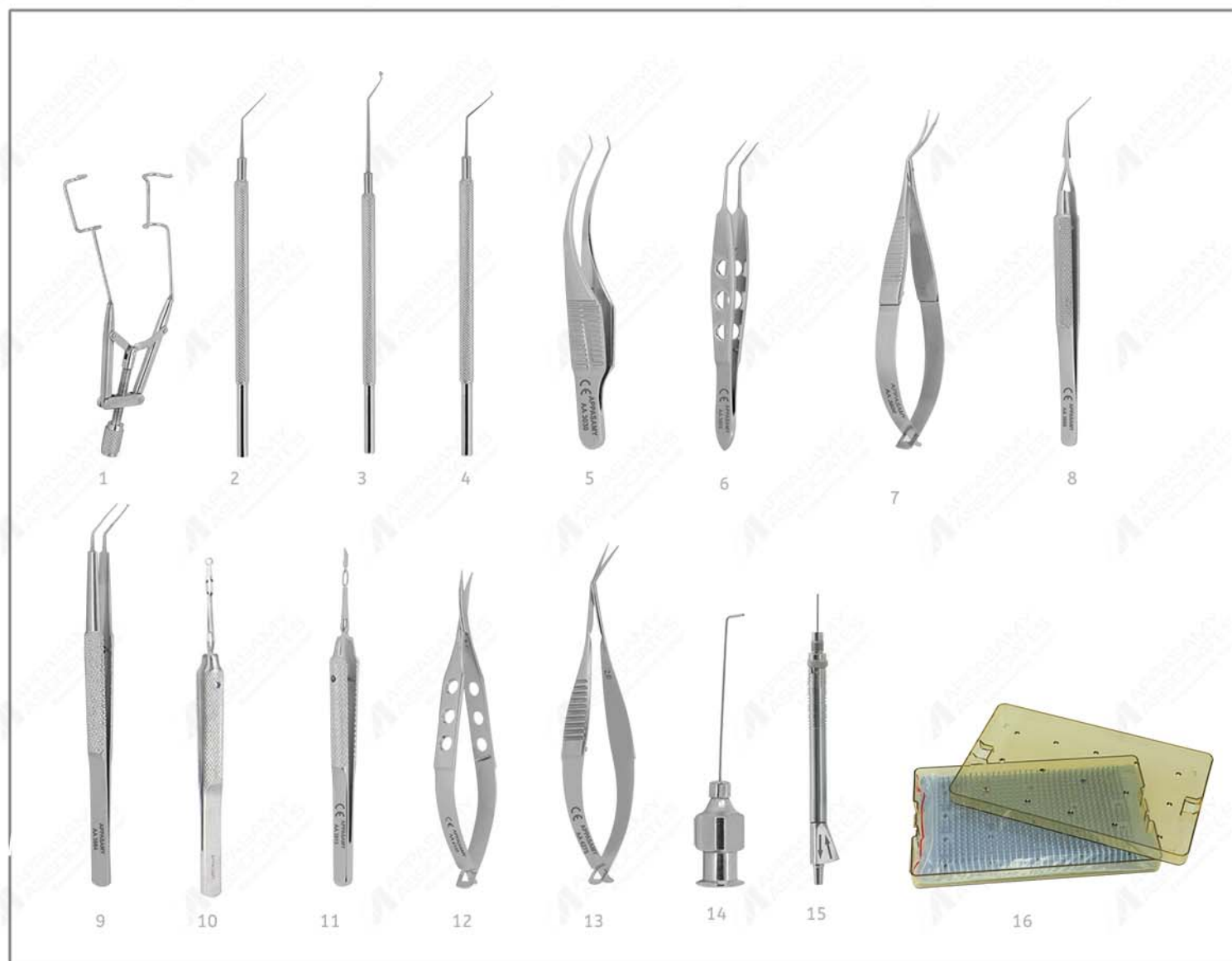

- 01.AA 1184 Lieberman Temporal Speculum
- 02.AA 1465 Sinskey II Lens Manipulating Hook Angled
- 03.AA 1597A Akahoshi Nucleus Ring Sustainer
- 04.AA/AAT 2000 Nagahara Karate Chopper Straight
- 05.AA 3030 Barraquer Colibri Forceps 1x2 Teeth 0.12mm
- 06.AA 3805 Mc Pherson IOL Forceps 11mm Angled
- 07.AA 3856 Inamura Capsulorhexis Forceps
- 08.AA 3860 Akahoshi Capsulorhexis Cross Action forceps
- 09.AA 3864 Giannetti Capsulorhexis Forceps
- 10.AA 3907 Akahoshi Nucleus Splitter Forceps
- 11.AA 3913B Akahoshi Combo Pre Chopper
- 12.AA 4155 Westcott Tenotomy Scissors
- 13.AA 4275 Vannas Capsulotomy Scissors Angle Forward 11mm
- 14.AA 7295 Akahoshi Hydrodissection Cannula 27G
- 15.AAT 7393/94 I/A Probe Set (Silicone Tip W/O Pin)Aspi.sand blas.Tip.Top Open
- 16.AA 8200 Appasamy See-Through Plastic Sterilization Tray

AA - Stainless Steel, AAT - Titanium, AAD - Disposable Instruments

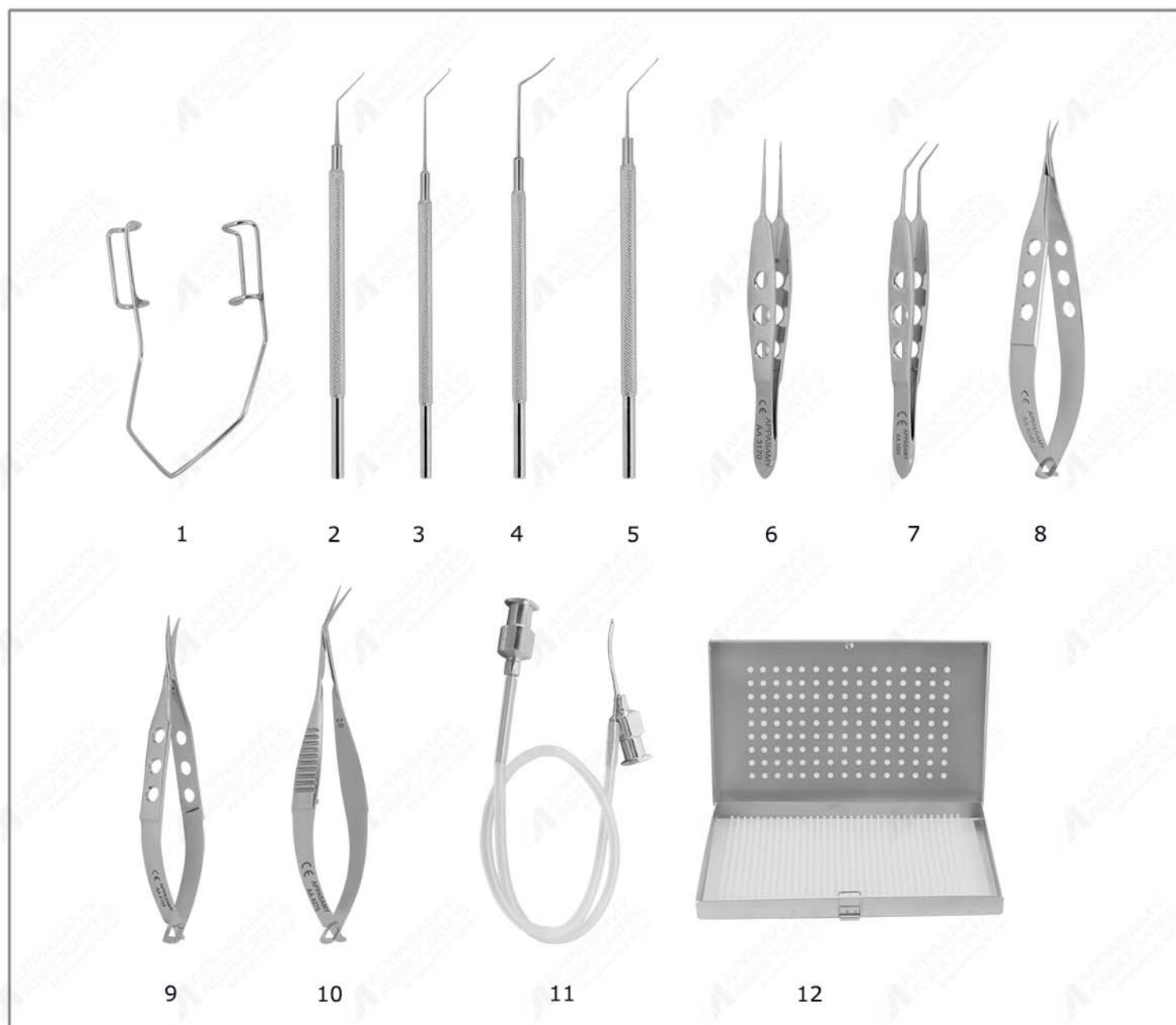

- 01.AA 1009 Barraquer Wire Speculum, Large
- 02.AA 1465 Sinsky II Lens Manipulating Hook Angled
- 03.AA 1597 Akahoshi Nucleus Ball Sustainer
- 04.AA 1655 Barraquer Iris Spatula 0.25mm, Angled
- 05.AA 1993 Agarwal Phaco Chopper 1mm Fully Cutting Edge
- 06.AA 3170 Bonn Forceps Long Model 0.12mm, 1x2 Teeth
- 07.AA 3805 Mc Pherson IOL Forceps
- 08.AA 4040 Castroviejo Corneal Scissors Small Blades
- 09.AA 4155 Westcott Tenotomy Scissors
- 10.AA 4275 Vannas Capsulotomy Scissors
- 11.AA 7420 Simcoe I/A Cannula 23G `Direct`
- 12.AA 8005 Appasamy Sterilization Tray With One Silicone Mat

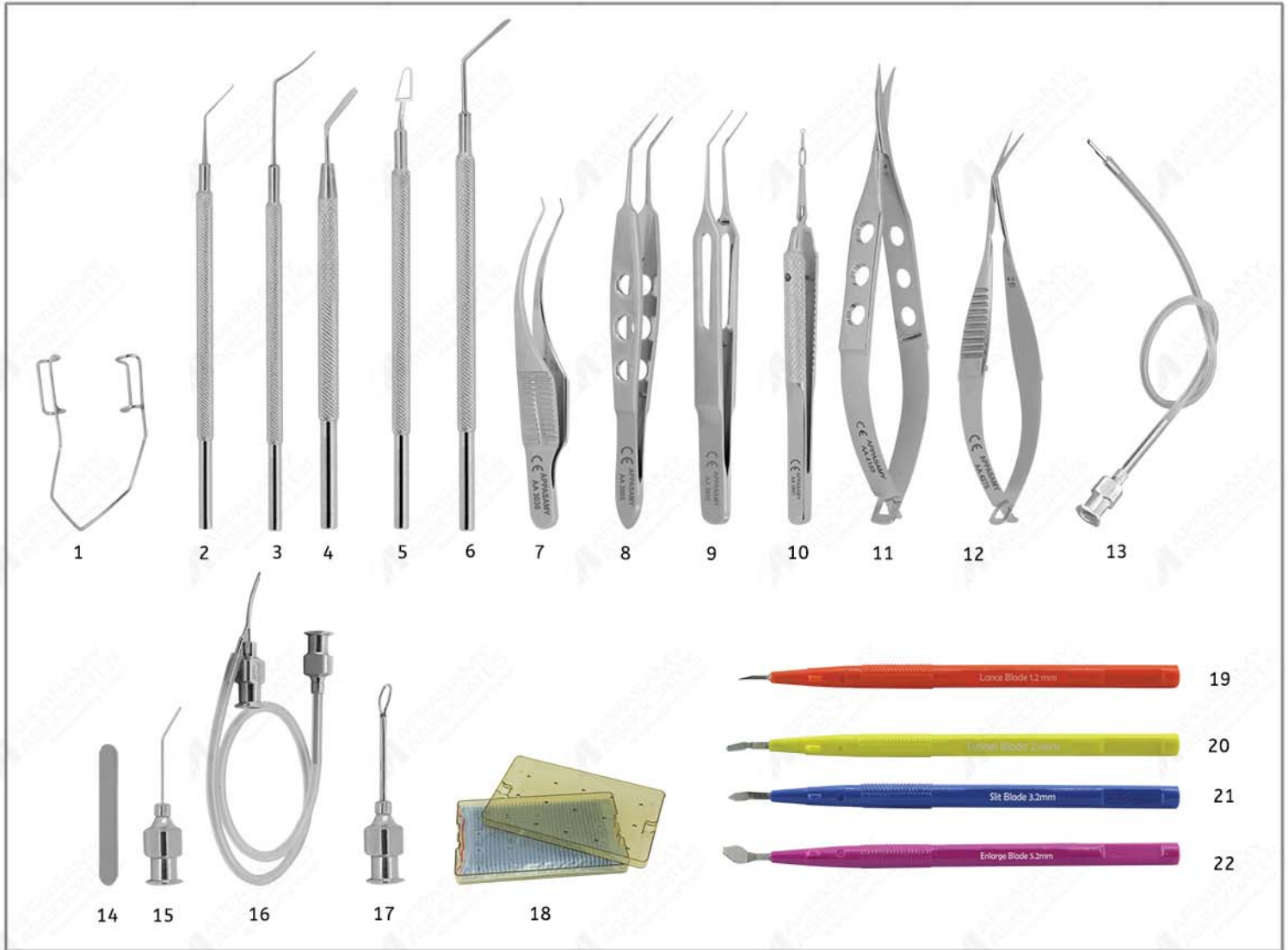

- | | |
|---------------|--|
| 1. AA 1009 | Barraquer Wire Speculum, Large |
| 2. AA 1465 | Sinsky II Lens Manipulating Hook |
| 3. AA 1655 | Barraquer Iris Spatula |
| 4. AA 1965 | Kansas Nucleus Bisector |
| 5. AA 1970 | Kansas Nucleus Trisector |
| 6. AA 1975 | Kansas Nucleus Vectis Solid, Right |
| 7. AA 3030 | Barraquer Colibri Forceps |
| 8. AA 3805 | Mc Pherson IOL Forceps |
| 9. AA 3855 | Utrata Capsulorhexis Forceps, Long Straight Shanks |
| 10. AA 3907 | Akahoshi Nucleus Splitter Forceps |
| 11. AA 4155 | Westcott Tenotomy Scissors |
| 12. AA 4275 | Vannas Capsulotomy Scissors |
| 13. AA 7150 | Lewicky A/C Maintainer |
| 14. AA 7202 | IOL Glide, Silicone |
| 15. AA 7205 | Pearce Hydrodissection Cannula, 25G |
| 16. AA 7447 | Ruit Irrigating/Aspirating Cannula, 23G |
| 17. AA 7705 | Knolle-Pearce Irrigating Vectis, 4mm Wide, 7mm Long Loop |
| 18. AA 8200 | Appasamy Plastic Sterilization Box |
| 19. AA 560012 | Lance Blade (Side Port Blade), 1.2mm |
| 20. AA 561021 | Tunnel Blade (Crescent Blade), 2.1mm |
| 21. AA 562032 | Slit Blade (Entry Keratome Blade), 3.2mm |
| 22. AA 563052 | Slit Enlarge Blade (IOL Implant Blade), 5.2mm |

AA - Stainless Steel, AAT - Titanium, AAD - Disposable Instruments

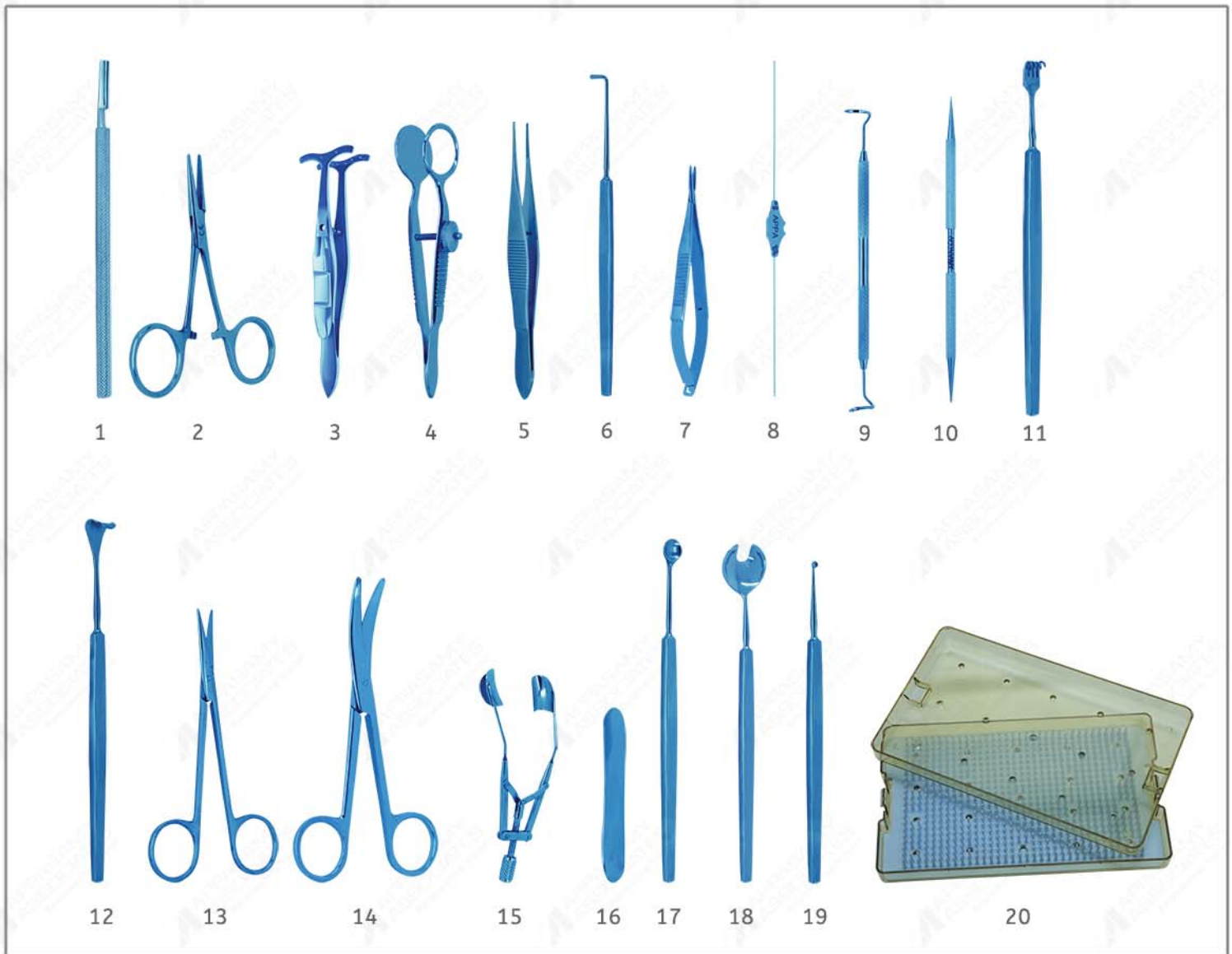

1. **AAT 5465** Bard-Parker Handle #3 Round Handle
2. **AAT 3920** Hartman Mosquito Forceps Straight
3. **AAT 3631** Putterman Type Lid Clamp
4. **AAT 3628** Desmarres Chalazion Forceps
5. **AAT 3300** Fixation Forceps 1x2 Teeth
6. **AAT 1826** Graefe Muscle Hook Size 2
7. **AAT 5065** Castroviejo Needle Holde
8. **AAT 6175** Bowman Lacrimal Probe,
9. **AAT 6150** Pigtail Probe With Suture Holes
10. **AAT 6440** Lacrimal Dilator Double-End

11. **AAT 1225** Knapp Lacrimal Sac Retractor Sharp
12. **AAT 1262** Desmarres Lid Retractor Solid blades size 2
13. **AAT 4530** Enucleation Scissors Ring handle Medium Curve
14. **AAT 4580** Enucleation Scissors Ring handle Medium Curve
15. **AAT 1187** Lieberman - Tennant Eye Speculum
16. **AAT 1740** Jaeger Lid Plate
17. **AAT 1880** Bunge Evisceration Spoon Small
18. **AAT 1890** Enucleation Spoon
19. **AAT 1877** Meyerhoefer Chalazion Curette Size 2
20. **AA 8200** Plastic Sterilizing Tray with Silicon Mat

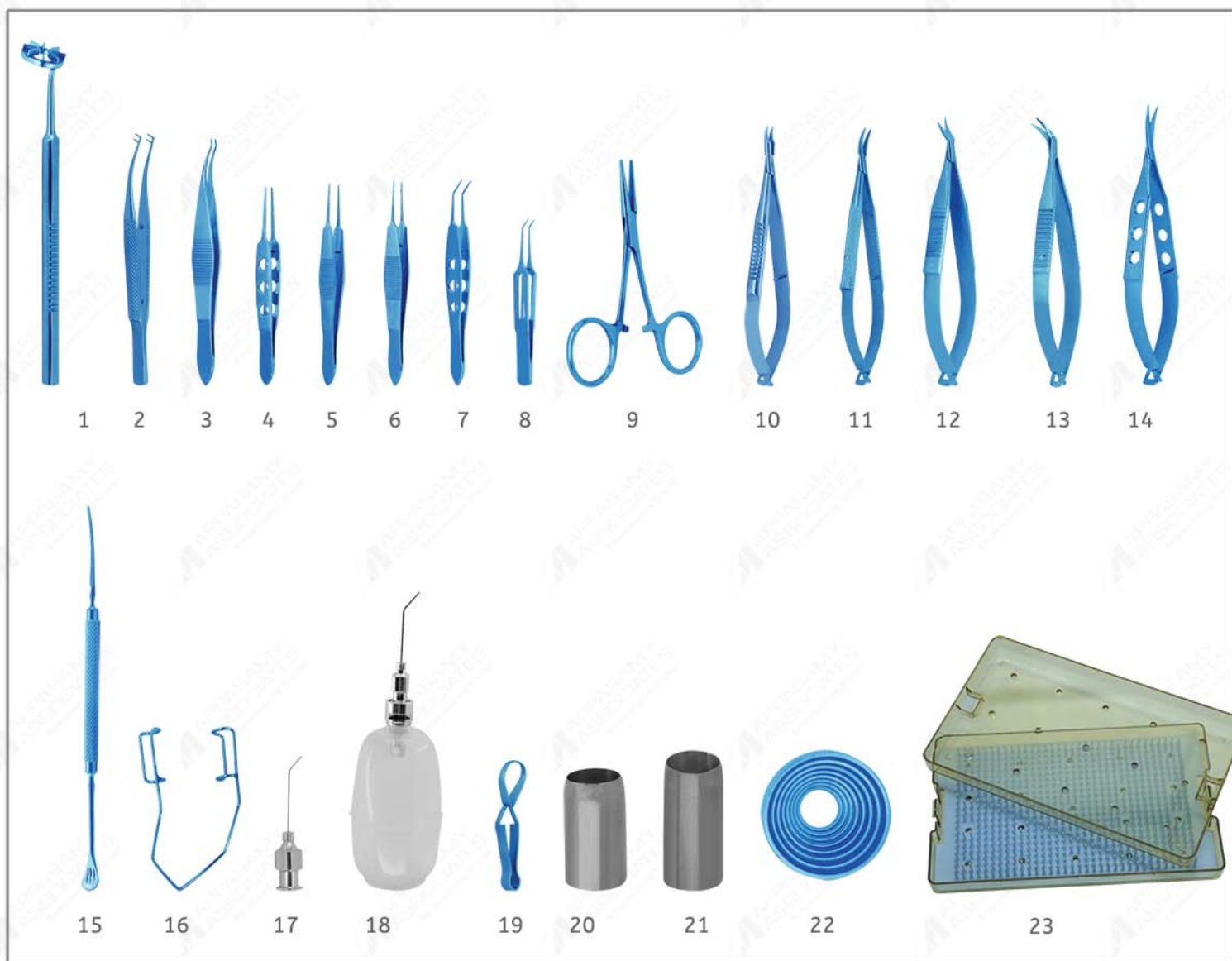

- | | | | |
|---------------------|--|---------------------|---|
| 1. AAT 2270 | Anis Suture Placement Marker | 14. AAT 4155 | Westcott Tenotomy Scissors |
| 2. AAT 3056 | Polack Double Corneal Forceps for corneal suturing | 15. AAT 1710 | Paton Spatula & Spoon |
| 3. AAT 3130 | Castroviejo Colibri Forceps very delicate, 1 x 2 teeth | 16. AAT 1009 | Barraquer Wire Speculum, Large |
| 4. AAT 3250 | Bishop-Harmon Tissue Forceps 1 x 2 teeth | 17. AA 7105 | Rycroft Air Injection Cannula, 23g |
| 5. AAT 3180 | Castroviejo Suturing Forceps 1 x 2 teeth | 18. AA 7830 | Silicone Bulb With Adaptor |
| 6. AAT 3185 | Castroviejo Suturing Forceps 1 x 2 teeth | 19. AAT 3945 | Baby Jones Towel Clamp |
| 7. AAT 3800 | Kelman-Mc Pherson Forceps 7.5mm angle long handle | 20. AA 2028 | Appasamy Corneal Trephine Size 7.5mm dia |
| 8. AAT 3795 | Mc Pherson Tying Forceps smooth jaws Long Handle | 21. AA 2029 | Appasamy Corneal Trephine Size 8mm dia |
| 9. AAT 3920 | Hartman Mosquito Forceps extra delicate | 22. AAT 2183 | Maloney Intra-Operative Keratometer |
| 10. AAT 5145 | Barraquer Needle Holder Short Model Micro Jaws | 23. AA 8200 | Plastic Sterilizing Tray with Silicon Mat |
| 11. AAT 5165 | Barraquer Needle Holder very delicate jaws | | |
| 12. AAT 4010 | Castroviejo Corneoscleral Scissors[s] blade left | | |
| 13. AAT 4015 | Castroviejo Corneoscleral Scissors [s] blade right | | |

AA - Stainless Steel, AAT - Titanium, AAD - Disposable Instruments

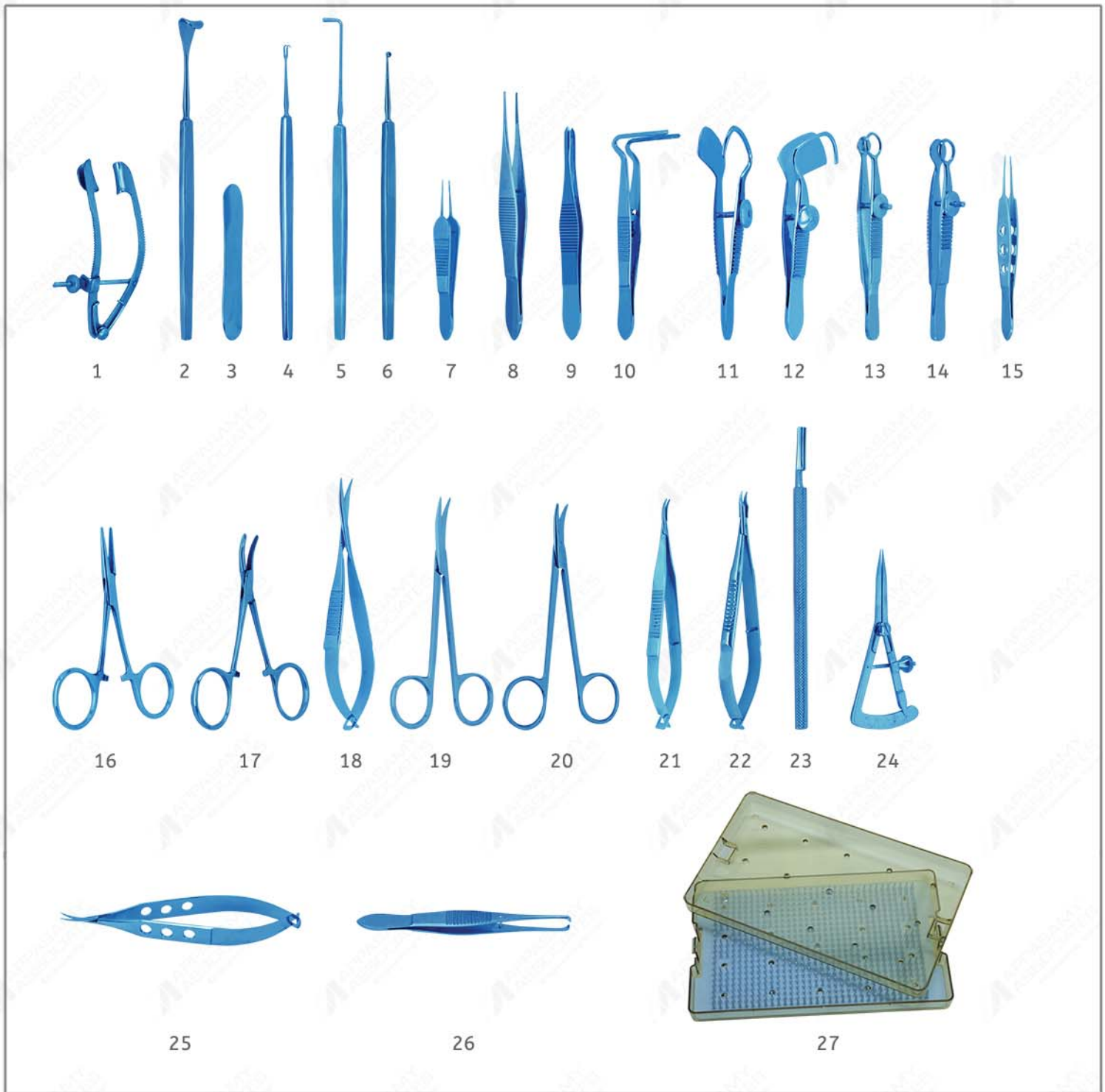

- | | |
|--|--|
| 1. AAT 1120 Lancaster Eye Speculum | 15. AAT 3790 Mc Pherson Tying Forceps St. Long handle |
| 2. AAT 1260 Desmarres Lid Retractor Size 0 | 16. AAT 3920 Hartman Mosquito Forceps Straight |
| 3. AAT 1740 Eye Lid Plate | 17. AAT 3925 Hartman Mosquito Forceps Curved |
| 4. AAT 1810 Fixation Hook Double Sharp 2.0 x 1.5 mm small | 18. AAT 4180 Westcott Stitch Scissors |
| 5. AAT 1827 Graefe Muscle Hook Size 3 | 19. AAT 4515 Eye Scissors Curved 4 1/2" Length |
| 6. AAT 1877 Meyerhoefer Chalazion Curette Size 2 | 20. AAT 4535 Stevens Tenotomy Scissors Curved |
| 7. AAT 3275 St. Martin Suturing Forceps 1x2 teeth teeth | 21. AAT 5095 Castroviejo Needle Holder Standard Jaws |
| 8. AAT 3300 Fixation Forceps 1x2 Teeth | 22. AAT 5145 Barraquer N.Holder Short Model M.jaws,w/o lock |
| 9. AAT 3485 Beer Cilia Forceps | 23. AAT 5460 Bard- Parker Handle #3 Flat |
| 10. AAT 3565 Berke Ptosis Forceps 20mm | 24. AAT 2075 Castroviejo Caliper 20mm spread |
| 11. AAT 3600 Snellen Entropium Forceps Left small | 25. AAT 4040 Castroviejo Corneal Scissors Small blades |
| 12. AAT 3605 Snellen Entropium Forceps Right small | 26. AAT 3310 Fixation Forceps-2x3 Teeth Angular |
| 13. AAT 3615 Ayer Chalazion Forceps | 27. AA 8200 Plastic Sterilizing Tray with Silicon Mat |
| 14. AAT 3620 Lambert Chalazion Forceps | |

AA - Stainless Steel, AAT - Titanium, AAD - Disposable Instruments



1. **AAT 1996** Rosen Phaco Splitter
2. **AAT 1485** Hook / Manipulator
3. **AAT 2140** Limbal Relaxing Incision (LRI) Gauge
4. **AAT 2183** Keratometer
5. **AA 2300** Marking Pen
6. **AAT 2820** LRI Marker, 6mm & 8mm chord lengths
7. **AAT 2825** LRI Marker, 40-60-80 degree
8. **AAT 2800** LRI Axis Marker
9. **AAT 2830** Pre-Op Toric Reference Marker w/Bubble Level
10. **AAT 2840** LRI Slit Lamp Marker
11. **AAT 3415** Fixation Forceps
12. **AAT 3715** Lens Holding Forceps
13. **AAT 3710** Lieberman Micro-Ring Lens Forceps 1.2mm dia
14. **AA 8200** Plastic Sterilizing Tray with Silicon Mat

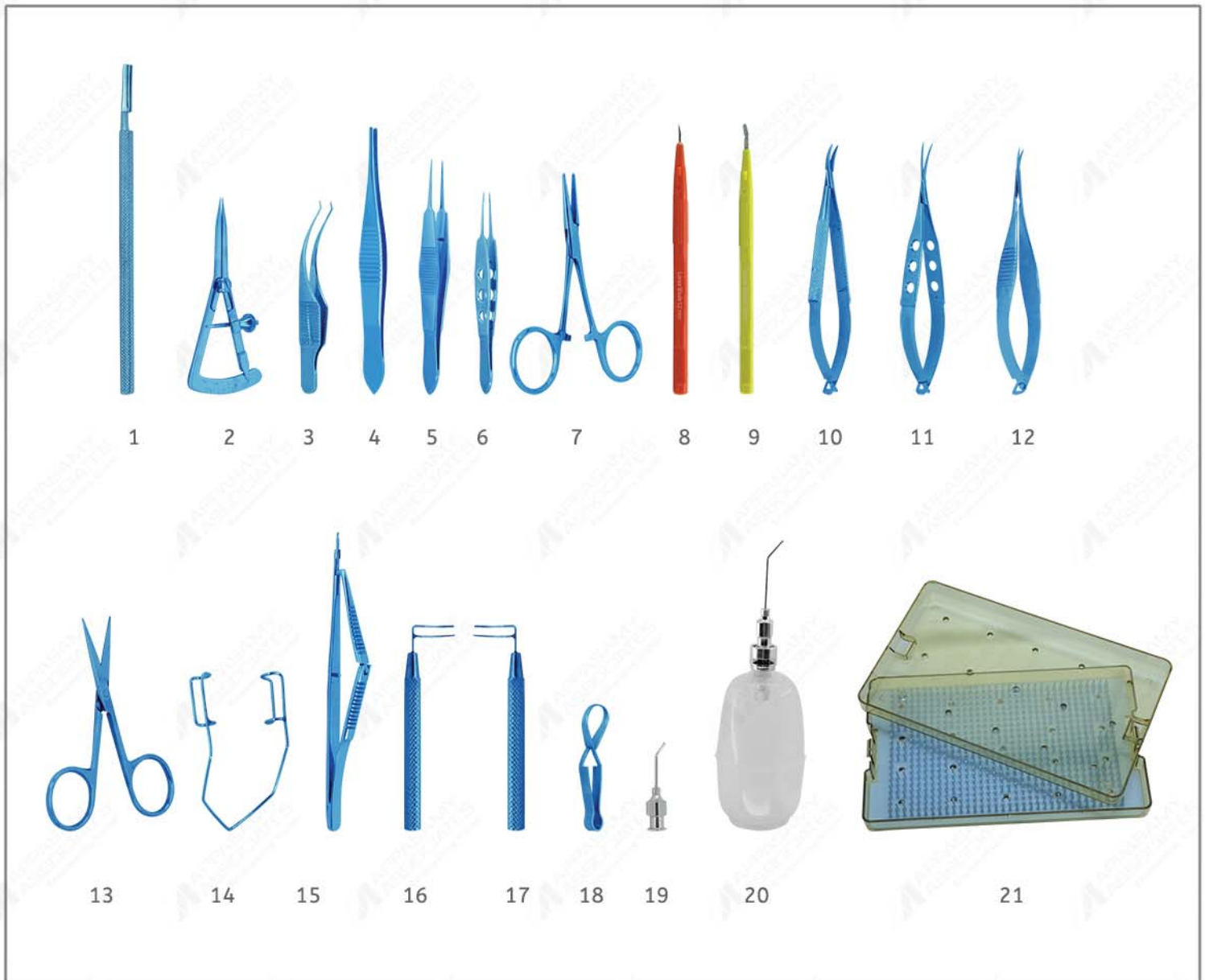

- | | |
|--|--|
| 1. AAT 5465 Bard-Parker Handle #3 Round Handle | 13. AAT 4500 Iris Scissors Straight 3.5" Length |
| 2. AAT 2075 Castroviejo Caliper 20mm spread | 14. AAT 1009 Barraquer Wire Speculum, Large |
| 3. AAT 3030 Colibri Forceps 1x2 Teeth 0.12mm | 15. AAT 6070 Kelly s Descement s Membrane Punch,1.0mm |
| 4. AAT 3465 Bonaccolto Utility Forceps 1.2mm wide | 16. AAT 6160 Harms Trabeculotomy Probe Right |
| 5. AAT 3180 Castroviejo Suturing Forceps 0.12mm,1x2 teeth | 17. AAT 6170 Harms Trabeculotomy Probe Left |
| 6. AAT 3790 Mc Pherson Tying Forceps Long handle | 18. AAT 3945 Baby Jones Towel Clamp |
| 7. AAT 3920 Hartman Mosquito Forceps Straight | 19. AA 7125 Bracken A/C Cannula Curved 19G |
| 8. AA 560012 Lance Blade | 20. AA 7830 Silicone Bulb with Adaptor |
| 9. AA 561021 Tunnel Blade | 21. AA 8200 Plastic Sterilizing Tray with Silicon Mat |
| 10. AAT 5165 Barraquer Needle Holder very delicate jaws | |
| 11. AAT 4155 Westcott Tenotomy Scissors | |
| 12. AAT 4255 Vannas Capsulotomy | |



1. **AAT 5460** Bard- Parker Handle #3 Flat
2. **AAT 3180** Castroviejo Suturing Forceps 0.12mm, 1x2 teeth
3. **AAT 3300** Fixation Forceps 1x2 Teeth
4. **AAT 3790** Pherson Tying Forceps Long handle
5. **AAT 5165** Barraquer Needle Holder very delicate jaws
6. **AAT 4510** Eye Scissors Straight 4 1/2" Length
7. **AAT 1430** Algerbrush Corneal Rust Ring Remover Battery powered
8. **AAT 3465** Bonaccolto Utility Forceps 1.2mm wide
9. **AAT 1184** Lieberman Temporal Speculum
10. **AA 8201** Appasamy Sterilization Box, Complete

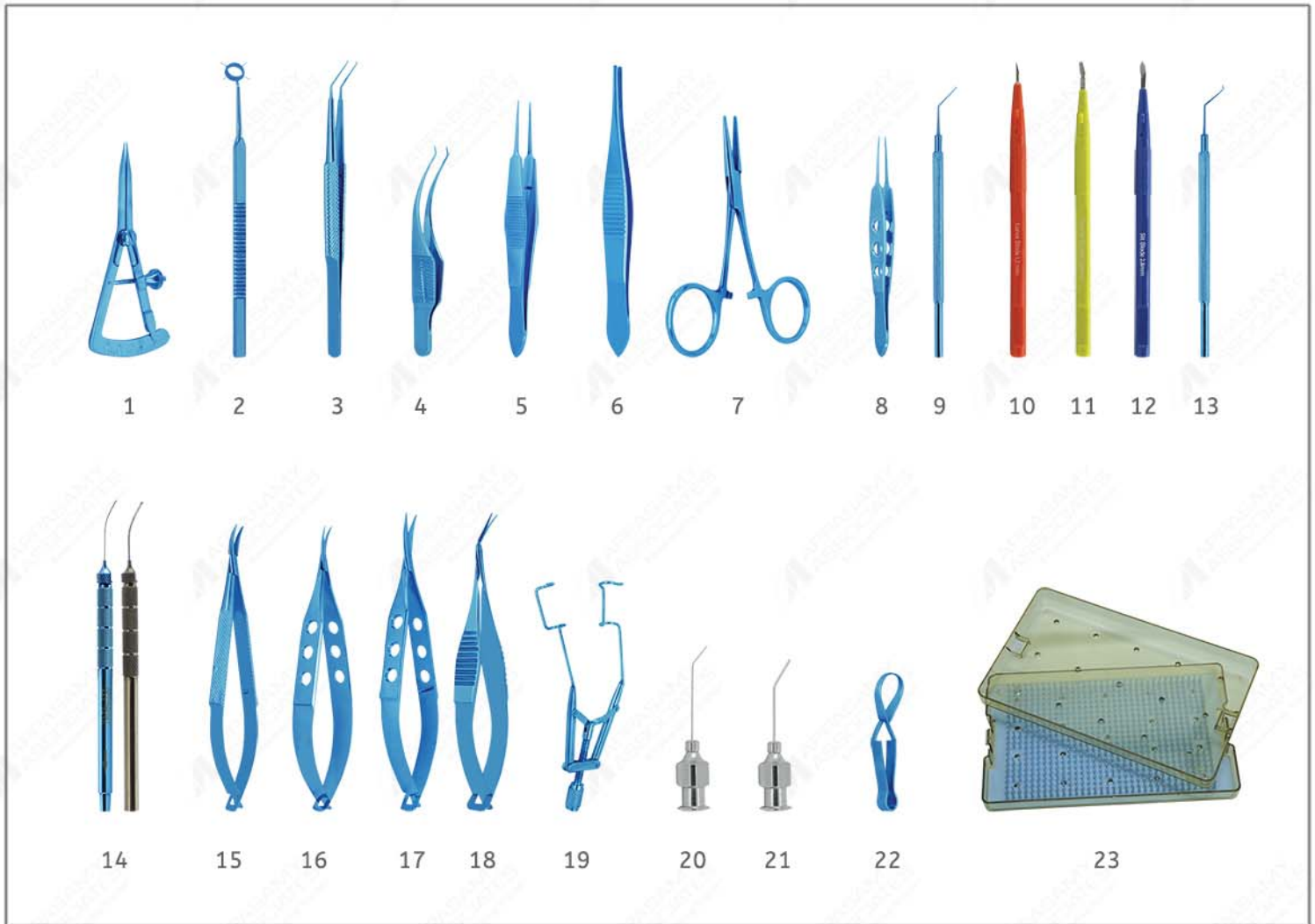

1. **AAT 2075** Castroviejo Caliper 20mm spread Straight
2. **AAT 2283** Capsulorhexis marker 6mm diameter marking ring
3. **AAT 3868** Utrata Capsulorhexis Forceps, Round Handle, Extra delicate
4. **AAT 3030** Barraquer Colibri Forceps
5. **AAT 3180** Castroviejo Suturing Forceps 0.12mm, 1x2 teeth
6. **AAT 3465** Bonaccolto Utility Forceps 1.2mm wide
7. **AAT 3920** Hartman Mosquito Forceps Straight
8. **AAT 3790** Mc Pherson Tying Forceps Long handle
9. **AAT 1465** Sinsky II Lens Manipulating Hook angled
10. **AA 560012** Lance Blade
11. **AA 561021** Tunnel Blade
12. **AA 562028** Slit Blade

13. **AAT 1993** Agarwal Phaco Chopper
14. **AAT 7410/11** Appasamy Bimanual Handle
15. **AAT 5165** Barraquer Needle Holder very delicate jaws
16. **AAT 4040** Castroviejo Corneal Scissors Small blades
17. **AAT 4155** Westcott Tenotomy Scissors
18. **AAT 4295** Gills-Vannas Capsulotomy Scissors
19. **AAT 1184** Lieberman Temporal Speculum
20. **AA 7107** Rycroft Air Injection Cannula 27g
21. **AA 7205** Pearce Hydrodissection Cannula, 25g
22. **AAT 3945** Baby Jones Towel Clamp
23. **AA 8200** Plastic Sterilizing Tray with Silicon Mat

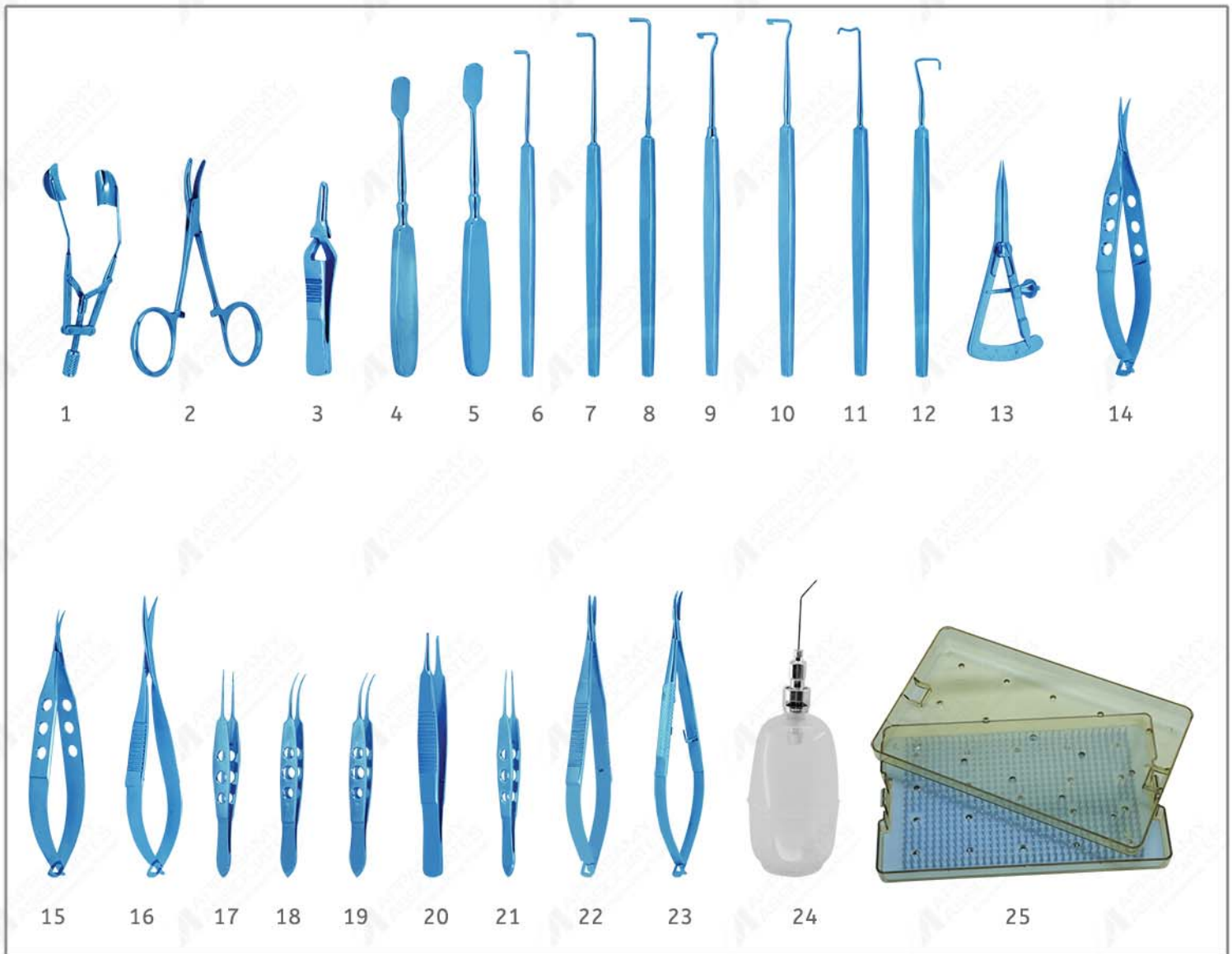

- | | |
|---|---|
| 1. AAT 1187 Lieberman - Tennant Eye Speculum Solid, blades | 15. AAT 4040 Castroviejo Corneal Scissors Small blades |
| 2. AAT 3925 Hartman Mosquito Forceps Curved | 16. AAT 4180 Westcott Stitch Scissors |
| 3. AAT 3950 Serrefine Small Straight | 17. AAT 3170 Bonn Forceps Long Model 0.12mm, 1 x 2 teeth |
| 4. AAT 1885 Mule Evisceration Scoop Small | 18. AAT 3350 Moody Fixation Forceps 1 x 2 teeth, 0.5mm Left |
| 5. AAT 1886 Mule Evisceration Scoop Large | 19. AAT 3351 Moody Fixation Forceps 1 x 2 teeth, 0.5mm Right |
| 6. AAT 1825 Graefe Muscle Hook Size 1 | 20. AAT 3330 Lester Fixation Forceps straight 1x2 teeth |
| 7. AAT 1826 Graefe Muscle Hook Size 2 | 21. AAT 3790 Mc Pherson Tying Forceps Long handle |
| 8. AAT 1827 Graefe Muscle Hook Size 3 | 22. AAT 5060 Castroviejo Needle Holder Straight, With Lock |
| 9. AAT 1835 Jameson Muscle Hook Small | 23. AAT 5160 Barraquer Needle Holder Curved with lock |
| 10. AAT 1837 Jameson Muscle Hook Large | 24. AA 7830 Silicone Bulb With Adaptor |
| 11. AAT 1850 Chavasse Muscle Hook | 25. AA 8200 Plastic Sterilizing Tray with Silicon Mat |
| 12. AAT 1855 Culler Rectus Muscle Hook | |
| 13. AAT 2075 Castroviejo Caliper 20mm spread Straight | |
| 14. AAT 4155 Westcott Tenotomy Scissors | |

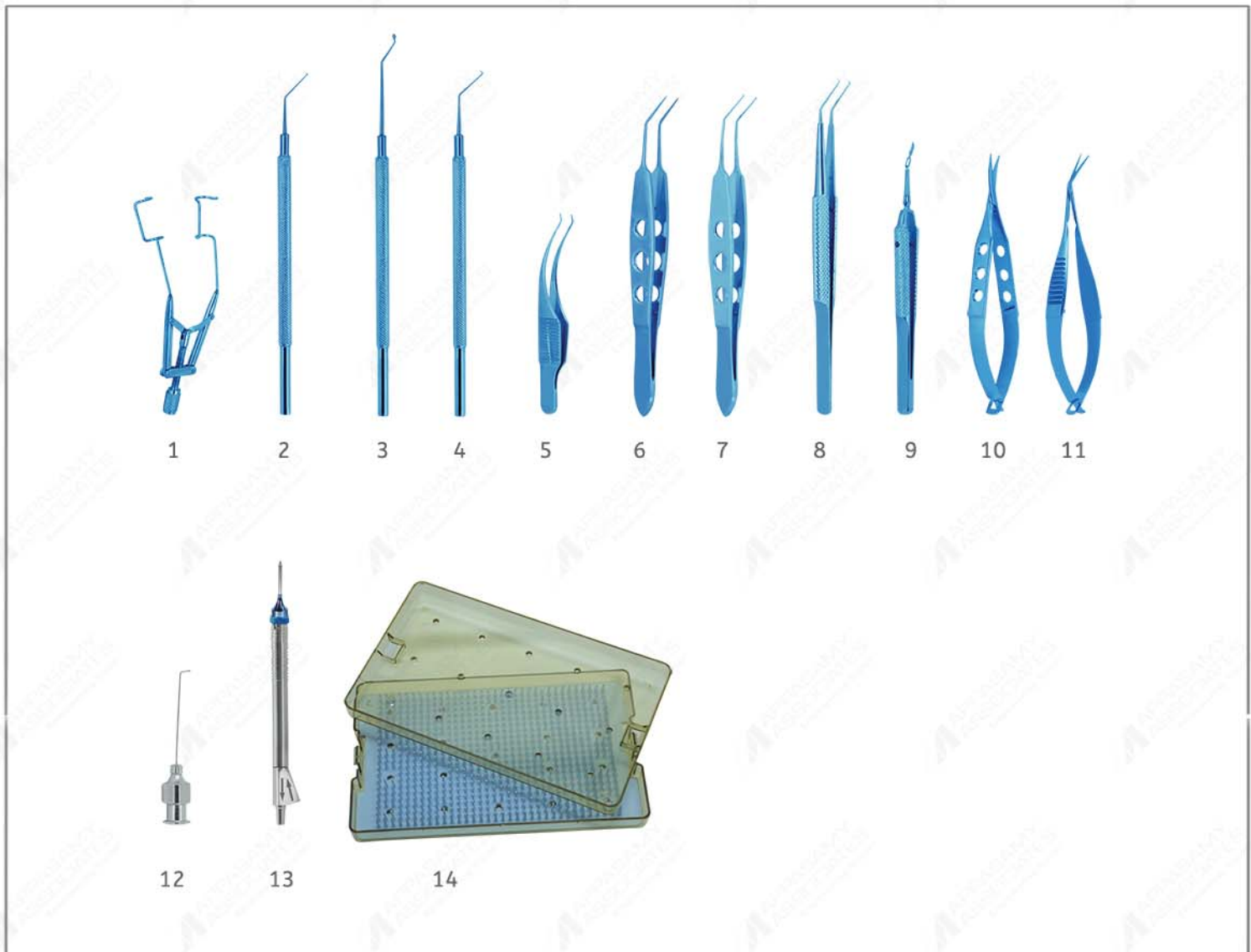

1. **AAT 1184** Lieberman Temporal Speculum
2. **AAT 1465** Sinsky II Lens Manipulating Hook angled
3. **AAT 1597A** Akahoshi Nucleus Ring Sustainer
4. **AAT 1989B** Mohan Rajan Micro Combo Chopper Pointed Tips 1.50mm
5. **AAT 3030** Barraquer Colibri Forceps 1x2 Teeth 0.12mm
6. **AAT 3805** Mc Pherson IOL Forceps 11mm Angled
7. **AAT 3855** Utrata Capsulorhexis Forceps
8. **AAT 3869** Utrata Forceps Straight Round Handle
9. **AAT 3913B** Akahoshi Combo Pre chopper
10. **AAT 4155** Westcott Tenotomy Scissors
11. **AAT 4275** Vannas Capsulotomy Scissors Angle forward 11mm
12. **AA 7295** Akahoshi Hydrodissection Cannula 27G
13. **AAT 7394** I/A Probe Set (silicone tip/W/O pin)Aspi.sand blas.tip.top open
14. **AA 8200** Plastic Sterilizing Tray with Silicon Mat

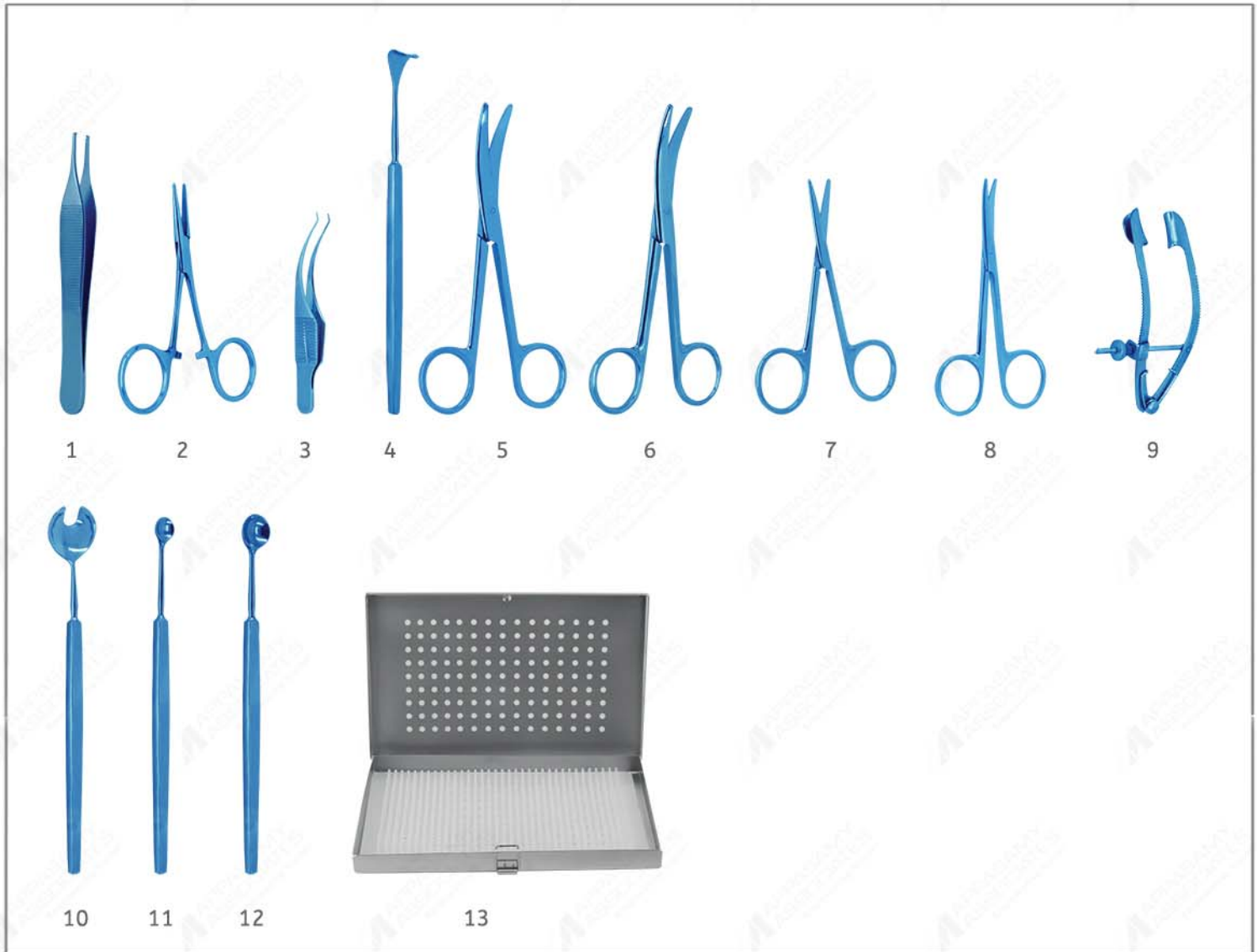

1. **AAT 3301** Adson Fixation forceps
2. **AAT 3920** Hartman Mosquito Forceps Straight
3. **AAT 3030** Barraquer Colibri Forceps 1x2 Teeth 0.12mm
4. **AAT 1261** Desmarres Lid Retractor size 1- 12mm width
5. **AAT 4580** Enucleation Scissors Ring handle Medium Curve
6. **AAT 4585** Enucleation Scissors Ring handle Strong Curve
7. **AAT 4550** Knapp Strabismus Scissorsblunt tipsring handle Straight
8. **AAT 4555** Knapp Strabismus Scissorsblunt tipsring handle Curved
9. **AAT 1120** Lancaster Eye Speculum
10. **AAT 1890** Wells Enucleation Spoon Small
11. **AAT 1880** Bunge Evisceration Spoon Small
12. **AAT 1881** Bunge Evisceration Spoon Large
13. **AA 8005** Sterlization Box

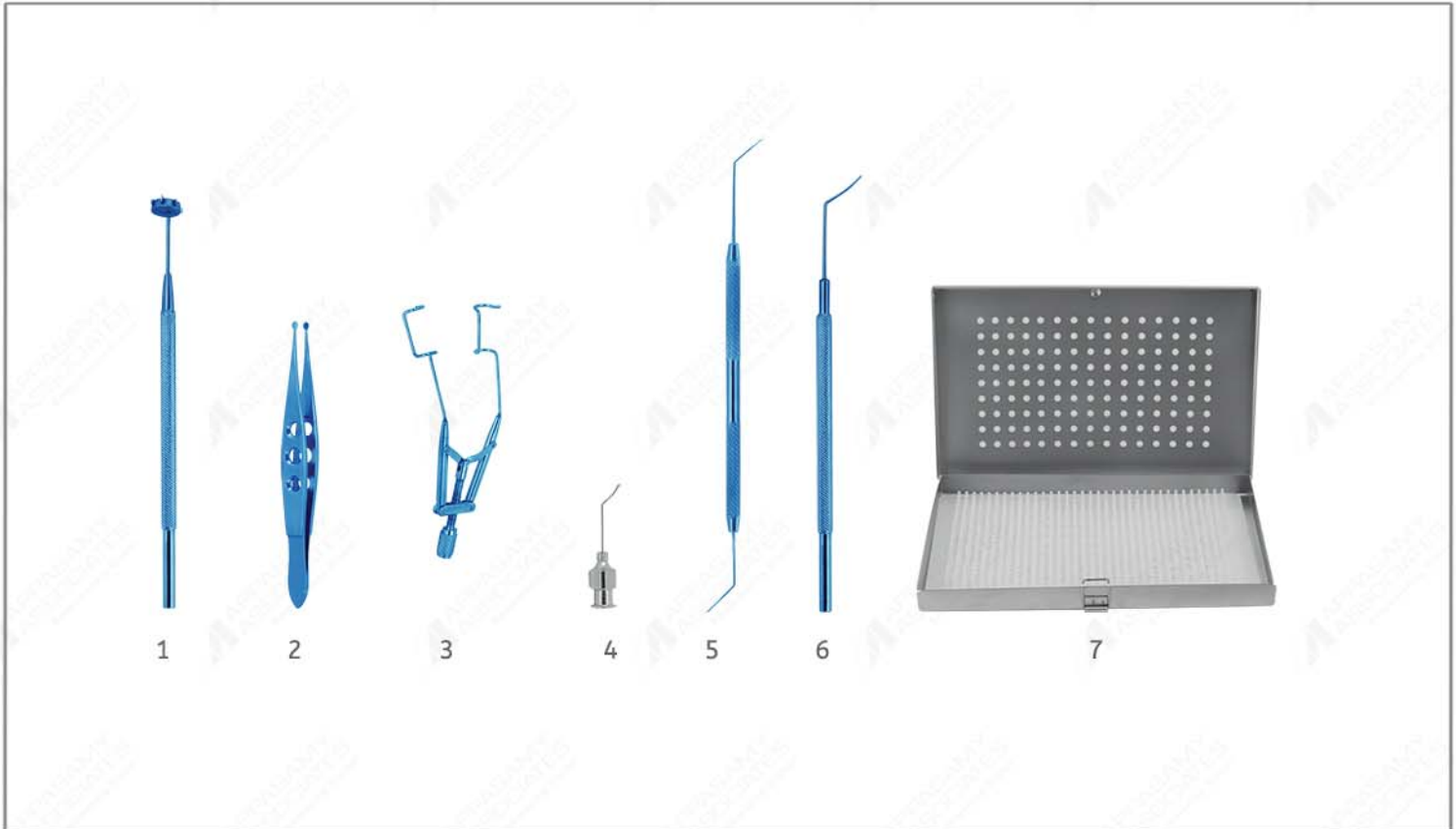

1. **AAT 2182** Appa Lasik Marker
2. **AAT 3876** Buratto LASIK Flap Forceps
3. **AAT 1184** Lieberman Temporal Speculum
4. **AA 7885** Buratto LASIK Cannula 23G
5. **AAT 1639** Lasik Flap Lifter Combines a 45° angled
6. **AAT 1666** Slade Femtosecond Spatula
7. **AA 8005** Sterlization Box

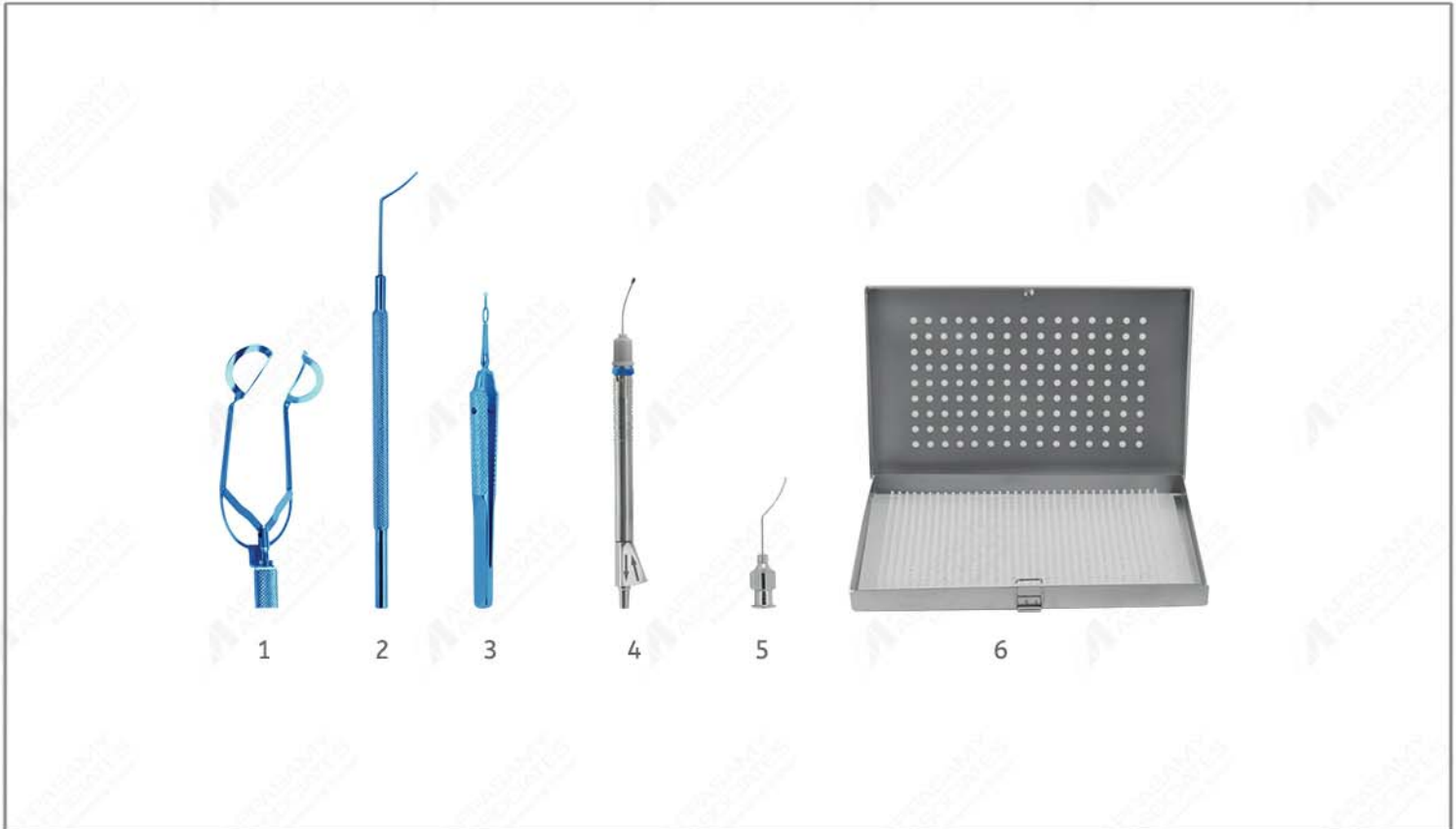

1. **AAT 1196** Jerome Bovert Speculum Reversible
2. **AAT 1666** Slade Femtosecond Spatula
3. **AAT 3907** Akahoshi Nucleus Splitter Forceps
4. **AAT 7393/98** I/A Probe Handle With S-Curve Polished
5. **AAT 7222** Slade Femtosecond Cannula
6. **AA 8005** Sterlization Box

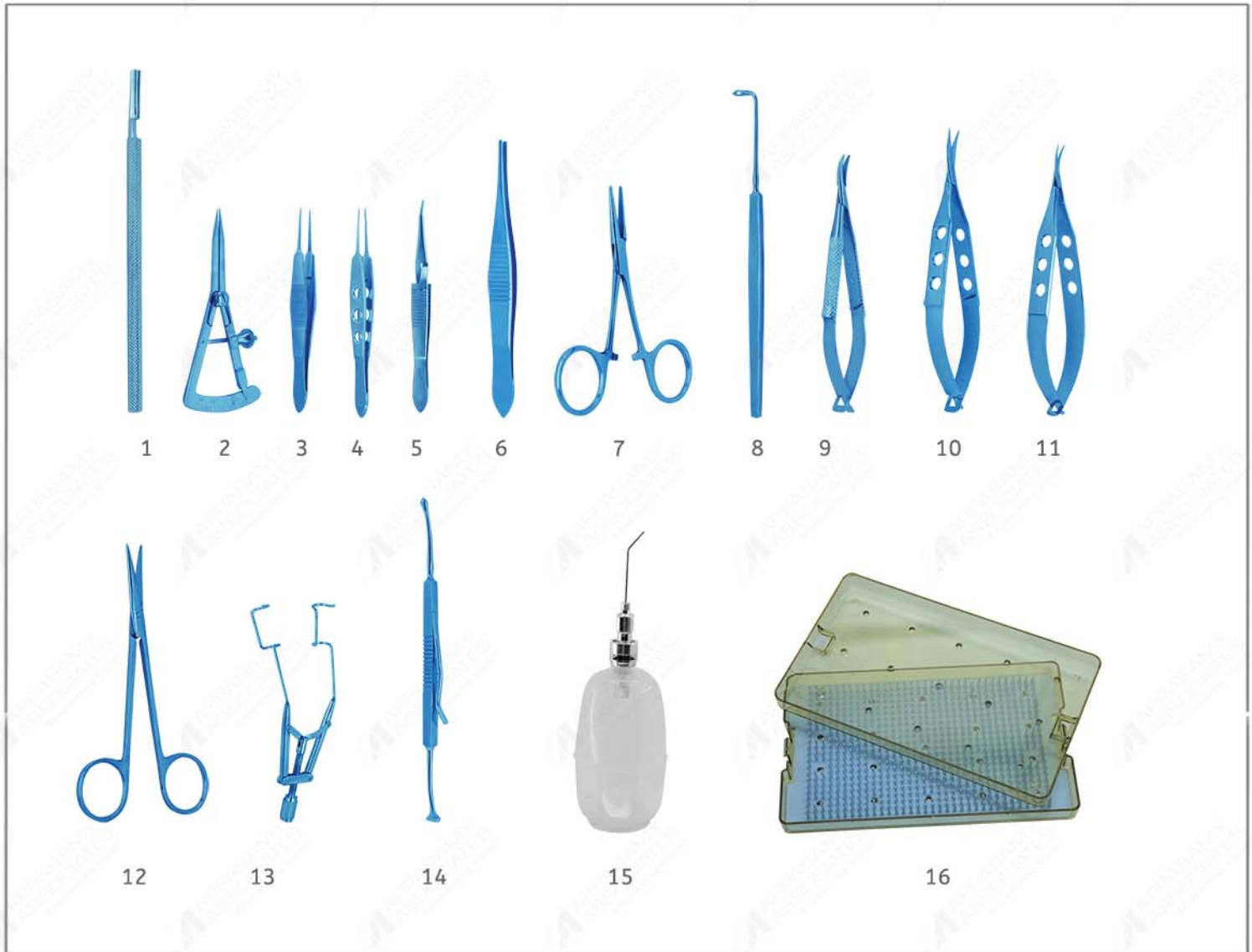

1. **AAT 5465** Bard-Parker Handle #3 Round Handle
2. **AAT 2075** Castroviejo Caliper 20mm spread Straight
3. **AAT 3180** Castroviejo Suturing Forceps 0.12mm,1x2 teeth
4. **AAT 3790** Mc Pherson Tying Forceps Long handle
5. **AAT 7930** Watzke Sleeve Spreading Forcepes
6. **AAT 3465** Bonaccolto Utility Forceps 1.2mm wide
7. **AAT 3920** Hartman Mosquito Forceps Straight
8. **AAT 1830** Gass Retinal Detachment Hook
9. **AAT 5135** Barraquer Needle Holdershort model Curved Without lock
10. **AAT 4155** Westcott Tenotomy Scissors
11. **AAT 4040** Castroviejo Corneal Scissors Small blades
12. **AAT 4530** Stevens Tenotomy Scissors blunt tips,ring handle Straight
13. **AAT 1184** Lieberman Temporal Speculum
14. **AAT 1310** Schocket Scleral Depressor Double-end with pocket clip
15. **AA 7830** Silicone Bulb With Adaptor
16. **AA 8200** Plastic Sterilizing Tray with Silicon Mat

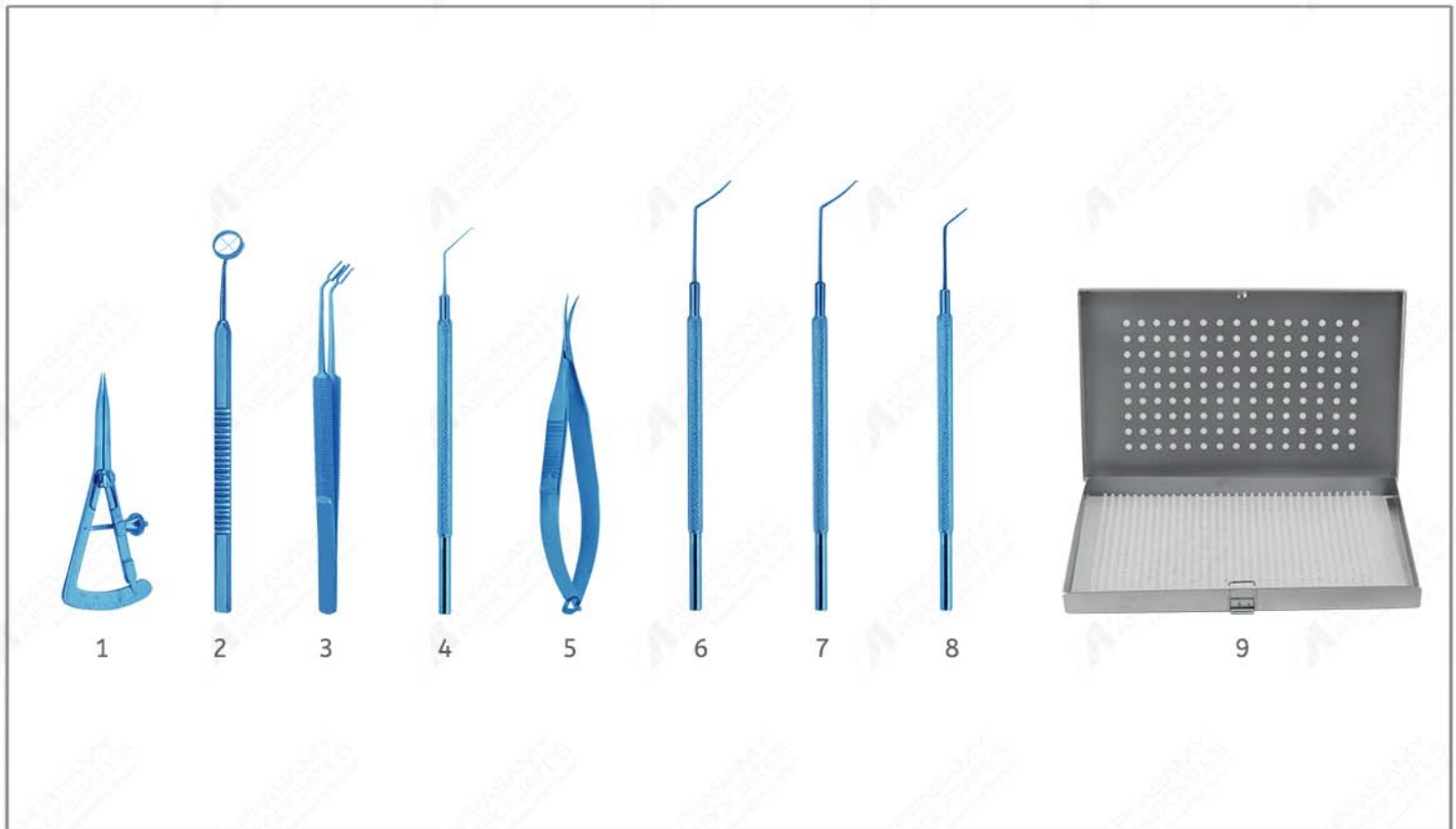

1. **AAT 2075** Castroviejo Caliper 20mm spread Straight
2. **AAT 2203** Hoffer Optic Zone Marker 8.00mm dia.
3. **AAT 3411** Neyses wallace Fixation
4. **AAT 2515** Dsek Reverse Sinsky Hook
5. **AAT 4110** Micro Iris Scissors Curved, pointed tips large blades
6. **AAT 1398** Corneal Dissector For intrastromal dissection angled, straight-blade
7. **AAT 1399** Corneal Dissector For intrastromal dissection angled, curved-blade
8. **AAT 2565** Bonfadini DALK Spatula 1mm wide, 8mm long
9. **AA 8005** Sterilization Box

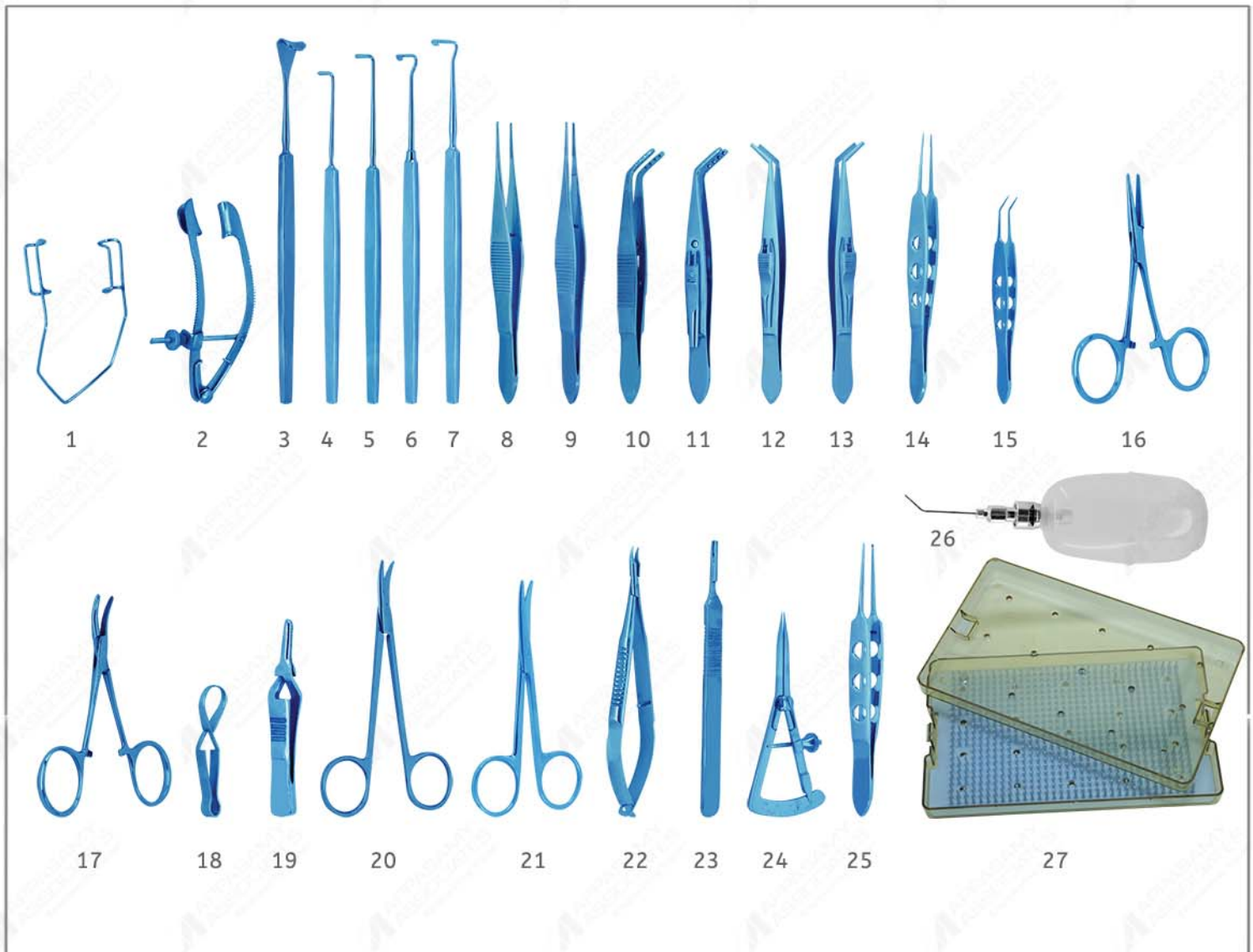

- | | |
|--|---|
| 1. AAT 1009 Barraquer Wire Speculum, large | 15. AAT 3800 Kelman-Mc Pherson Forceps 7.5mm angle long handle |
| 2. AAT 1120 Lancaster Eye Speculum | 16. AAT 3920 Hartman Mosquito Forceps Straight |
| 3. AAT 1260 Desmarres Lid Retractor Size 0 | 17. AAT 3925 Hartman Mosquito Forceps Curved |
| 4. AAT 1825 Graefe Muscle Hook Size 1 | 18. AAT 3945 Baby Jones Towel Clamp |
| 5. AAT 1826 Graefe Muscle Hook Size 2 | 19. AAT 3950 Serrefine Small Straight |
| 6. AAT 1835 Jameson Muscle Hook Small | 20. AAT 4535 Stevens Tenotomy Scissors Curved |
| 7. AAT 1837 Jameson Muscle Hook Large | 21. AAT 4555 Knapp Strabismus Scissors Curved |
| 8. AAT 3300 Fixation Forceps 1x2 Teeth | 22. AAT 5145 Barraquer N.Holder Short Model M.jaws,w/o lock |
| 9. AAT 3460 Wills Hospital Utility Forceps | 23. AAT 5460 Bard- Parker Handle #3 |
| 10. AAT 3535 Jameson Muscle Forceps Left Child 4 teeth | 24. AAT 2075 Castroviejo Caliper 20mm spread Straight |
| 11. AAT 3540 Jameson Muscle Forceps Right Child 4 teeth | 25. AAT 3255 Bishop-Harmon Tissue Forceps Delicate 0.8mm |
| 12. AAT 3555 Worth Advancement Forceps Left | 26. AA 7830 Silicone Bulb With Adaptor |
| 13. AAT 3560 Worth Advancement Forceps Right | 27. AA 8200 Plastic Sterilizing Tray with Silicon Mat |
| 14. AAT 3790 Mc Pherson Tying Forceps St. Long handle | |

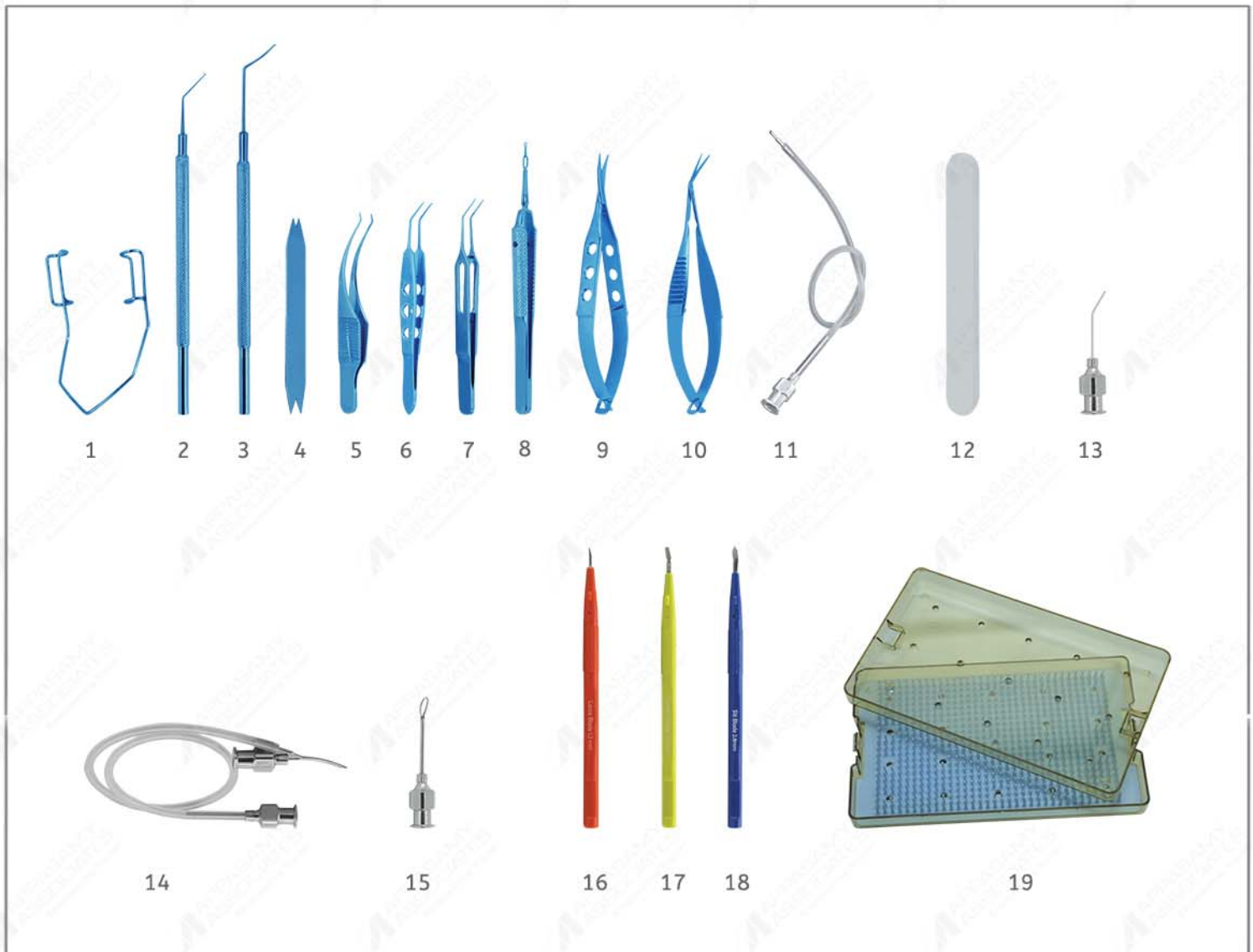

1. **AAT 1009** Barraquer Wire Speculum, large
2. **AAT 1465** Sinsky II Lens Manipulating Hook
3. **AAT 1655** Barraquer Iris Spatula
4. **AAT 2087** Appasamy Fixed Caliper Double end Size 3.0 & 3.5mm
5. **AAT 3030** Barraquer Colibri Forceps
6. **AAT 3805** Mc Pherson IOL Forceps
7. **AAT 3855** Utrata Capsulorhexis Forceps, Long Straight Shanks
8. **AAT 3907** Akahoshi Nucleus Splitter Forceps
9. **AAT 4155** Westcott Tenotomy Scissors
10. **AAT 4275** Vannas Capsulotomy Scissors
11. **AA 7150** Lewicky A/C Maintainer
12. **AA 7202** IOL Glide, Silicone
13. **AA 7205** Pearce Hydrodissection Cannula, 25g
14. **AA 7447** Ruit Irrigating/Aspirating Cannula, 23g
15. **AA 7705** Knolle-Pearce Irrigating Vectis, 4mm wide, 7mm long loop
16. **AA 560012** Lance Blade
17. **AA 561021** Tunnel Blade
18. **AA 562028** Slit Blade
19. **AA 8200** Plastic Sterilizing Tray with Silicon Mat

AA - Stainless Steel, AAT - Titanium, AAD - Disposable Instruments

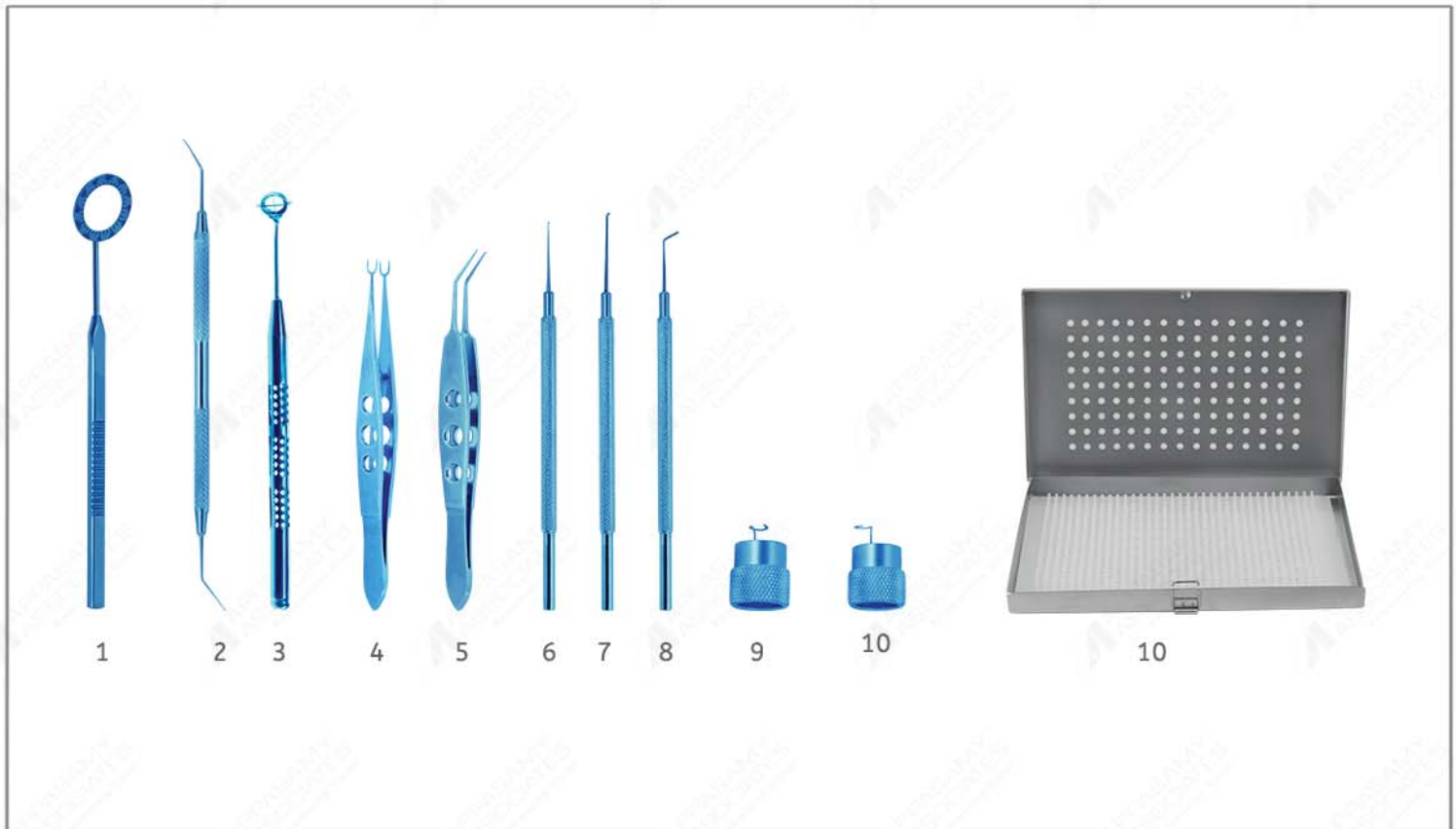

1. **AAT 2140** Limbal Relaxing Incision (LRI) Gauge
2. **AAT 2221** Optical Zone Marker Double ended
3. **AAT 2146** Tunnel Zone Marker
4. **AAT 3400** Bores Incision Spreading Forceps
5. **AAT 3671** Forceps For ICSR Implant
6. **AAT 2516** Flevator Far ICSR Implantation
7. **AAT 2517** SUAREZ SPREADER
8. **AAT 2518** Bicalto Guide
9. **AAT 2432** ICSR Tunnel Marker Left
10. **AAT 2433** ICSR Tunnel Marker Right
11. **AA 8005** Appasamy Sterilization Tray with one silicone mat

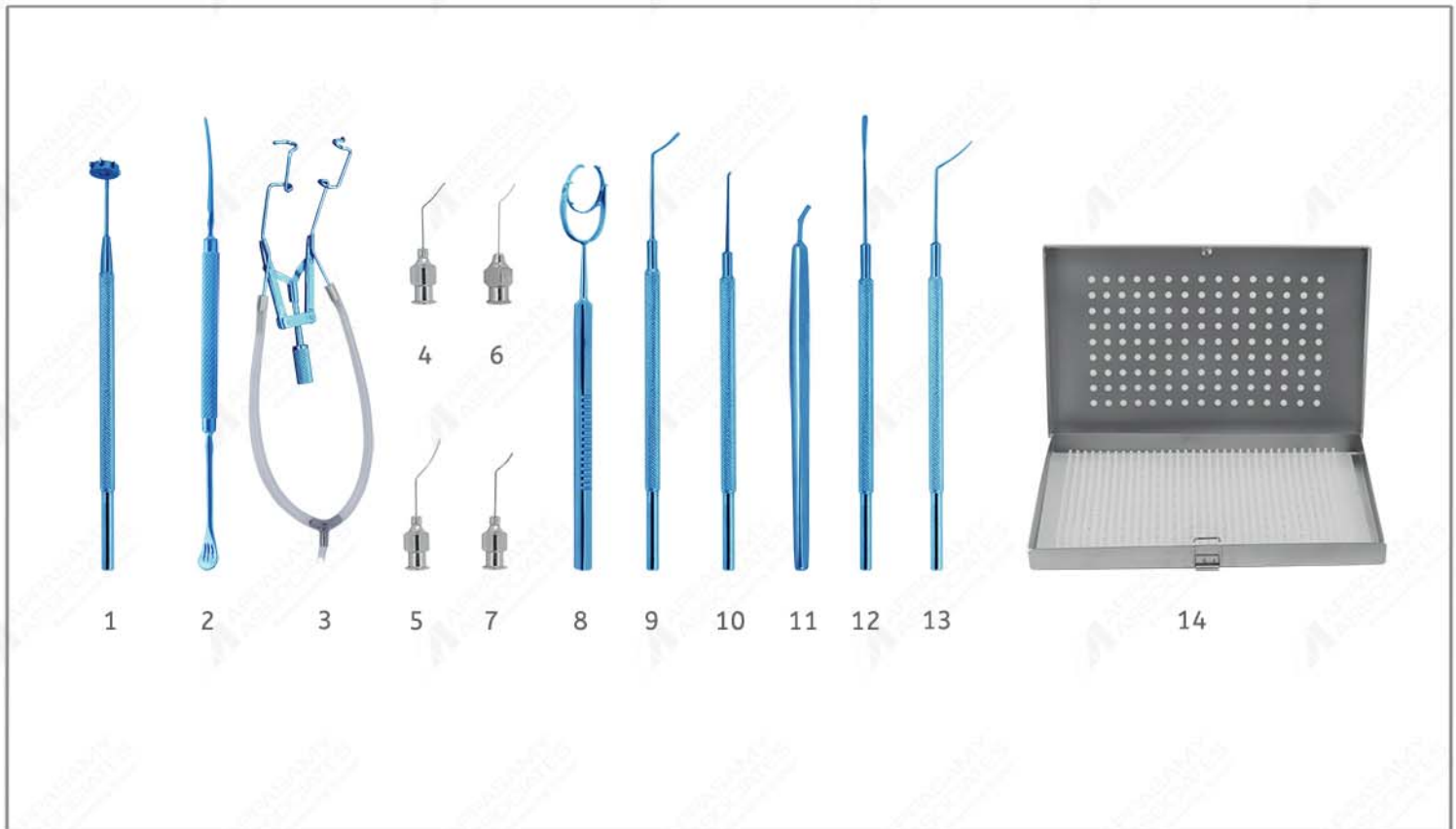

1. **AAT 2182** Appa Lasik Marker
2. **AAT 1710** Paton Spatula & Spoon
3. **AAT 1086** Thorlakson Aspirating Speculum
4. **AA 7880** Banaji Lasik Cannula (6 ports)
5. **AA 7222** Slade Femtosecond Cannula
6. **AA 7875** Gimbel Lasik Fountain Cannula 45° angled 5mm
7. **AA 7885** Buratto LASIK Cannula 23G
8. **AAT 1817** Shepard Fixation Ring
9. **AAT 1683** Lasik Spatula
10. **AAT 2517** Suarez Spreader
11. **AAT 2400** Lasek Hokey Knife
12. **AAT 2415** Lasek Epithelial Flap Repositioning Spatula
13. **AAT 1666** Slade Femtosecond Spatula
14. **AA 8005** Appasamy Sterilization Tray with one silicone mat

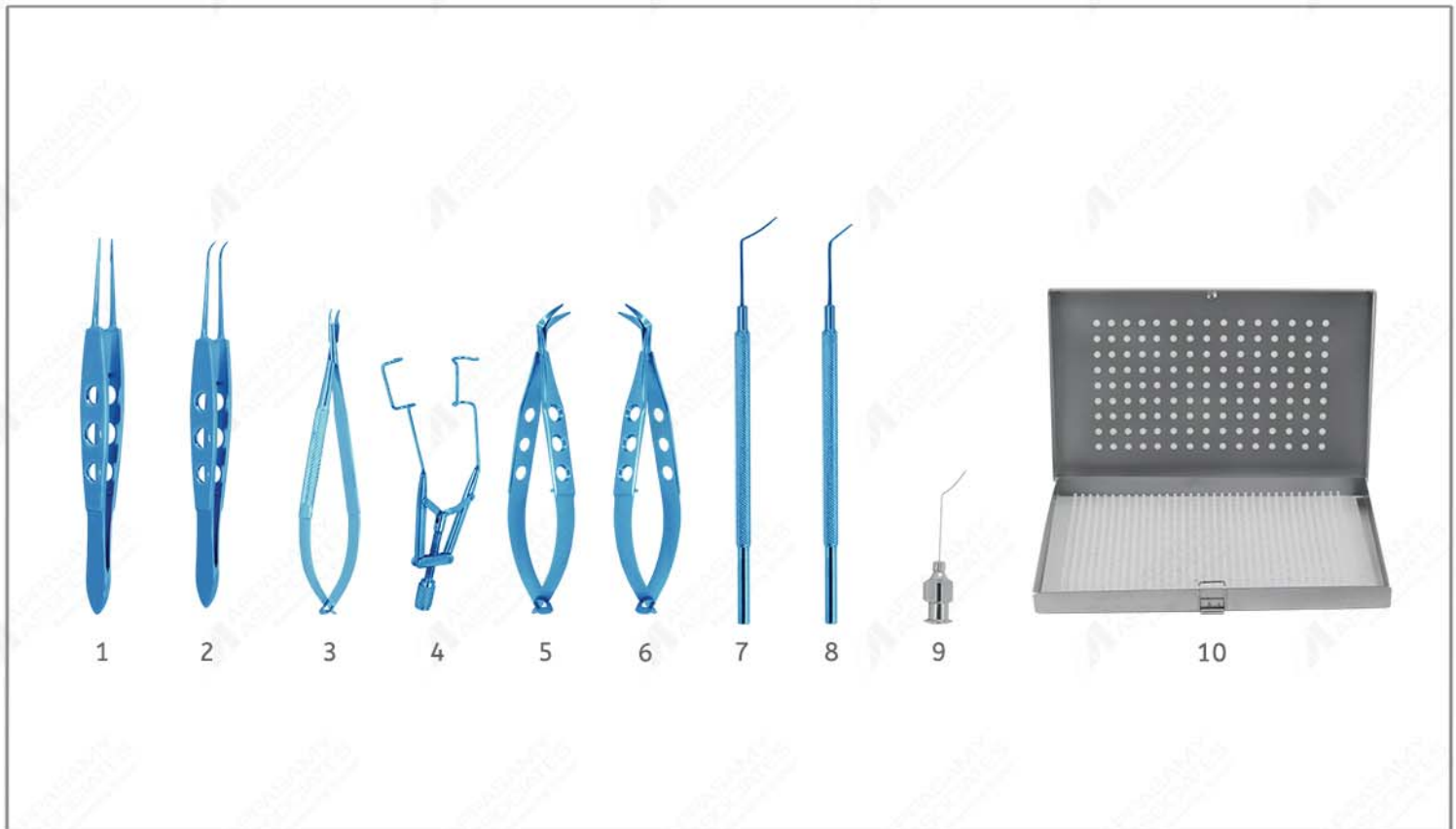

1. **AAT 3750** Jaffe Tying Forceps Smooth Jaws With 5mm Long Platform Straight
2. **AAT 3755** Jaffe Tying Forceps Smooth Jaws With 5mm Long Platform Curved
3. **AAT 5175** Barraquer Needle Holder Micro Without lock
4. **AAT 1184** Lieberman Temporal Speculum
5. **AAT 4020** Katzin Corneal Transplant Scissors, Right
6. **AAT 4025** Katzin Corneal Transplant Scissors, Left
7. **AAT 2560** Rosenwasser DALK Trisector
8. **AAT 2565** Bonfadini DALK Spatula
9. **AA 7100** DALK Air Injection Cannula
10. **AA 8005** Instruments Case, Small

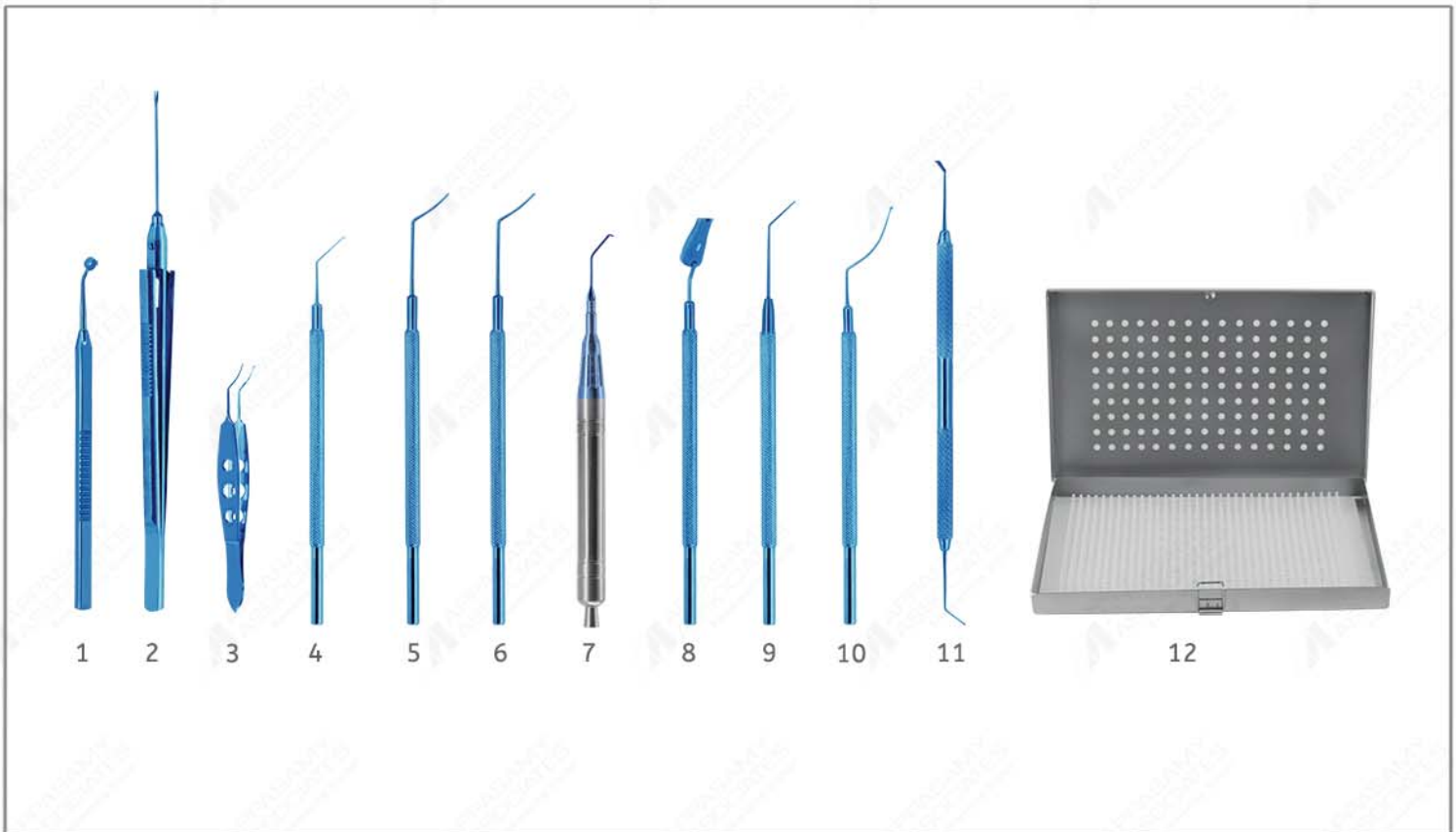

1. **AAT 2230** Hoffer Optic Zone Marker
2. **AAT 3990** DSEAK Grasping Forceps, 23g
3. **AAT 3731** Donor Lamellar Inserting Forceps
4. **AAT 2515** Reverse Sinskey Hook
5. **AAT 1398** Corneal Dissector, Straight Blade
6. **AAT 1399** Corneal Dissector, Vaulted Blade
7. **AAT 8325** Irrigating Endothelial Stripper 20 Gauge Tip Set
8. **AAT 1696** Busan Endothelial Glide
9. **AAT 1625A** Appasamy Plain Rod 11mm Angled
10. **AAT 2505** Dseak Stomal Scrubber
11. **AAT 2530** Rosenwasser Lamellar Donor Inserting Shovel
12. **AA 8005** Instruments Case, Small

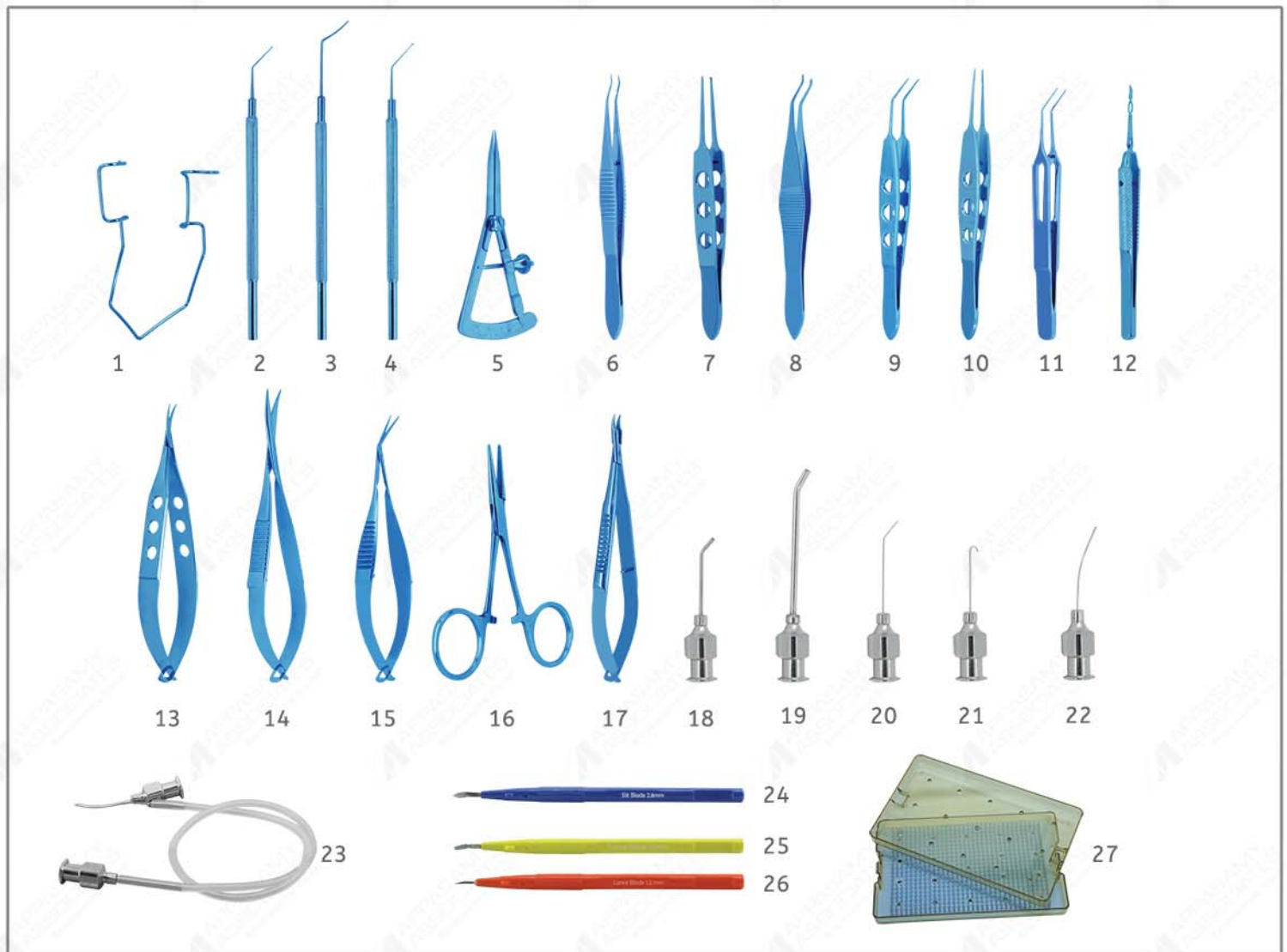

- | | |
|---|---|
| 1. AAT 1025 Kratz -Barraquer Wire Speculum,Big | 14. AAT 4180 Westcott Stitch Scissors |
| 2. AAT 1465 Sinsky II Lens Manipulating Hook angled | 15. AAT 4275 Vannas Capsulotomy Scissors Angle forward 11mm |
| 3. AAT 1655 Barraquer Iris Spatula | 16. AAT 3920 Hartman Mosquito Forceps Straight |
| 4. AAT 1993 Agarwal Phaco Chopper 1mm Fully cutting edge | 17. AAT 5145 Barraquer N.Holder Short Model Micro jaws, without lock |
| 5. AAT 2075 Castroviejo Caliper 20mm spread | 18. AA 7105 Recroft Air Injection annula 23G |
| 6. AAT 3145 Lim's Corneoscleral Forceps 0.12mm,1 x 2 teeth | 19. AA 7145 Anterior Chamber Washout Cannula 16G |
| 7. AAT 3255 Bishop-Harmon Tissue Forceps Delicate 0.8mm | 20. AA 7205 Pearce Hydrodissection Cannula , 35deg. angled 25G |
| 8. AAT 3340 Dastoor Superior Rectus Forceps,1x2 teeth | 21. AA 7215 Gimbel Shaped Hydrodissector,25G |
| 9. AAT 3805 Mc Pherson IOL Forceps 11mm Angled | 22. AA 7230 Kellan Hyderodelineation Cannula Curved Bevel Tip 25G |
| 10. AAT 3790 Mc Pherson Tying Forceps St. Long handle | 23. AA 7420 Simcoe I/A Cannula 23G `Direct` |
| 11. AAT 3855 Utrata Capsulorhexis Forceps Flat handle | 24. AA 560012 Lance Blade |
| 12. AAT 3913 Akahoshi Super Combo Prechopper | 25. AA 561021 Tunnel Blade |
| 13. AAT 4040 Castroviejo Corneal Scissors Small blades | 26. AA 562028 Slit Blade |
| | 27. AA 8200 Plastic Sterilizing Tray with Silicon Mat |

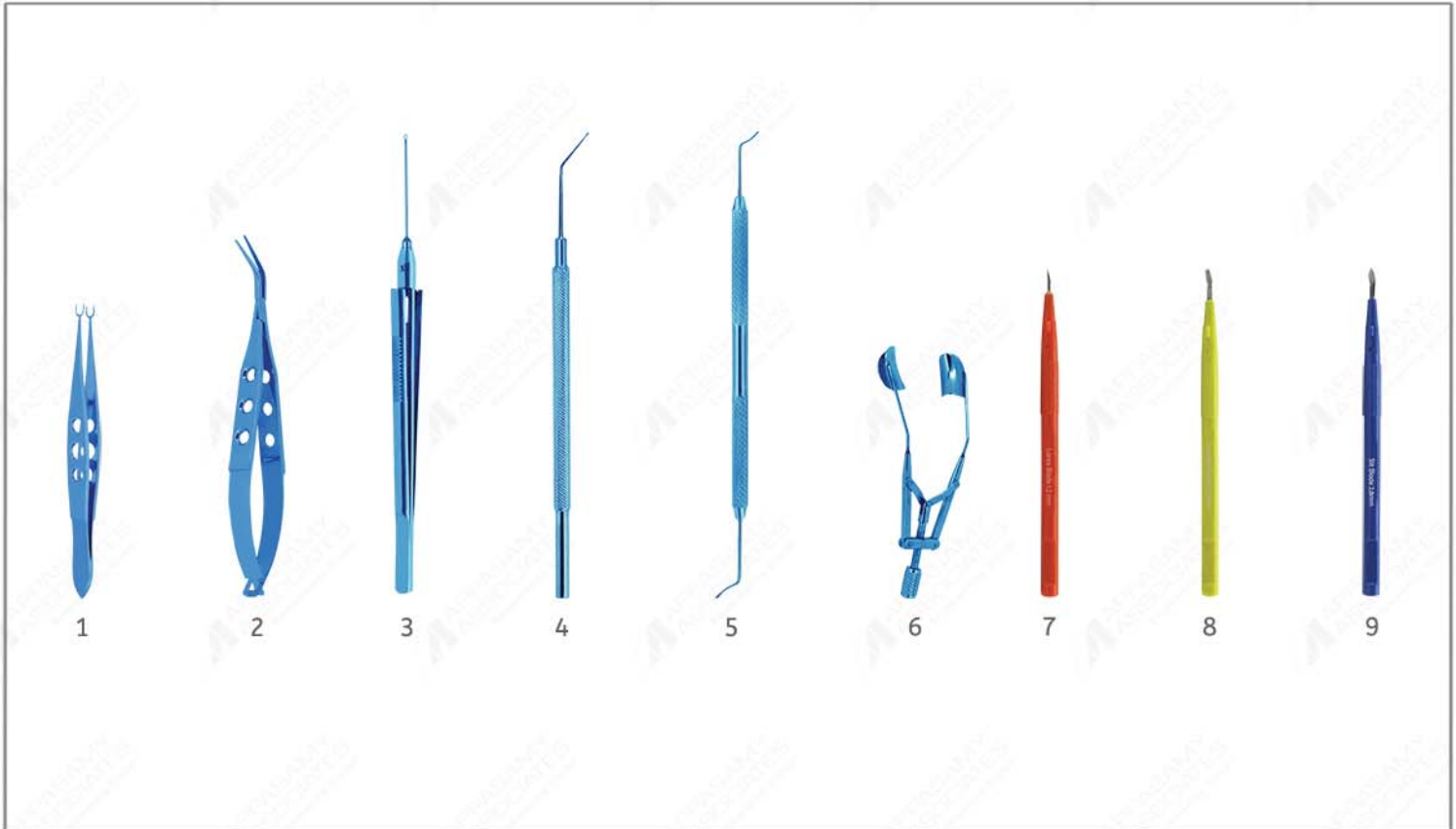

1. **AAT 3400** Bore Incision Spreading Forceps
2. **AAT 3721** Loading Forceps
3. **AAT 3987** Cartridge Forceps
4. **AAT 1482** Pallikaris Lens Manipulator
5. **AAT 1481** ZALDIVER LENS MANIPULATOR DOUBLE ENDED
6. **AAT 1184** Lieberman Temporal Speculum
7. **AA 560012** Lance Blade
8. **AA 561021** Tunnel Blade
9. **AA 562028** Slit Blade

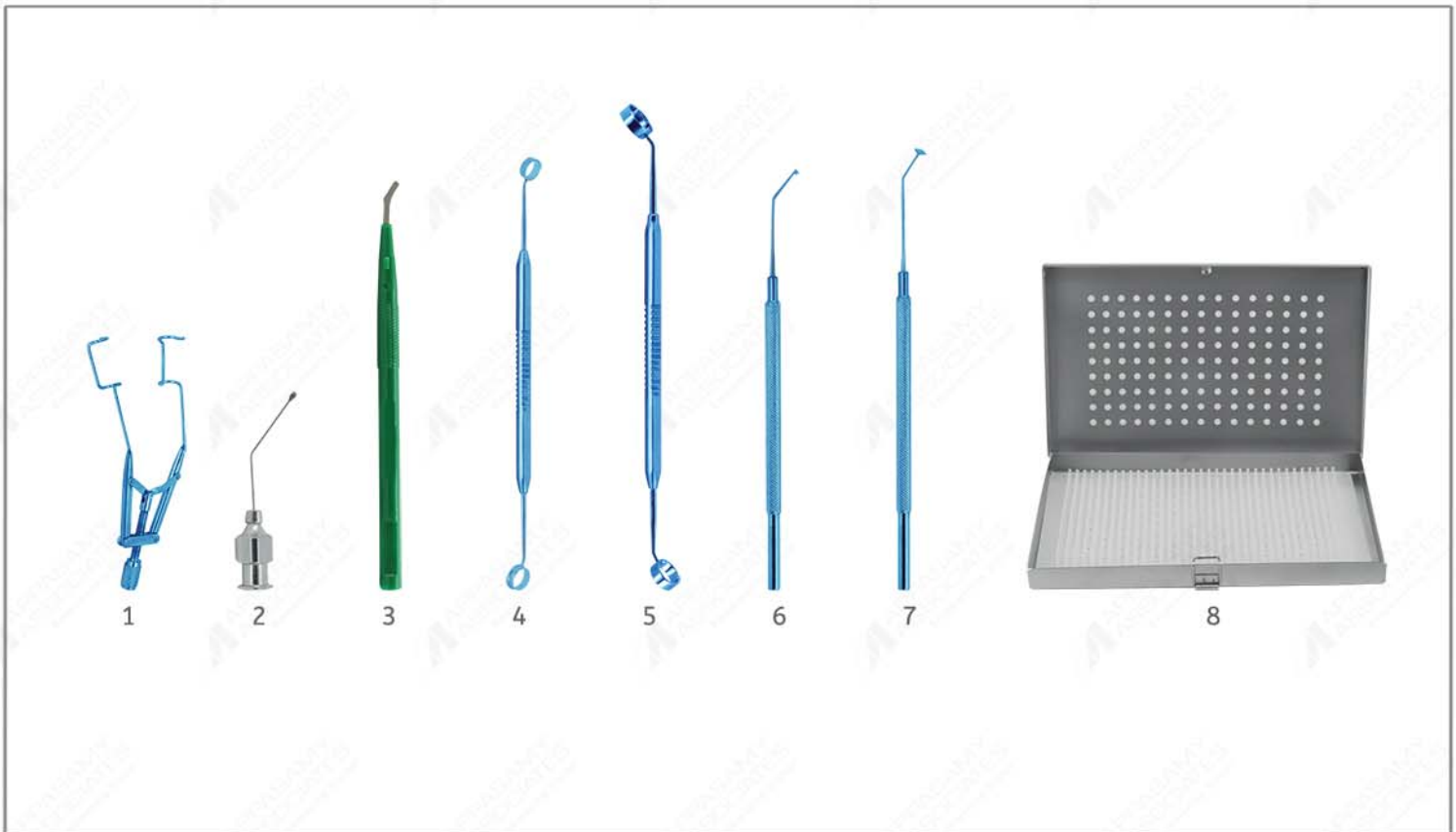

1. **AAT 1184** Lieberman Temporal Speculum
2. **AA 7345** Troutman Alpha-Chymotrypsin Cannula
3. **AAD 2400** Lasek Hokey Knife
4. **AAT 2430** Lasek Trepine 8mm & 8.5mm
5. **AAT 2425** Lasek Alcohol Well 8mm & 8.5mm
6. **AAT 2405** Lasek Epithelial detaching Spatula
7. **AAT 2410** Lasek Epithelial Micro Hoe
8. **AA 8005** Sterlization Box

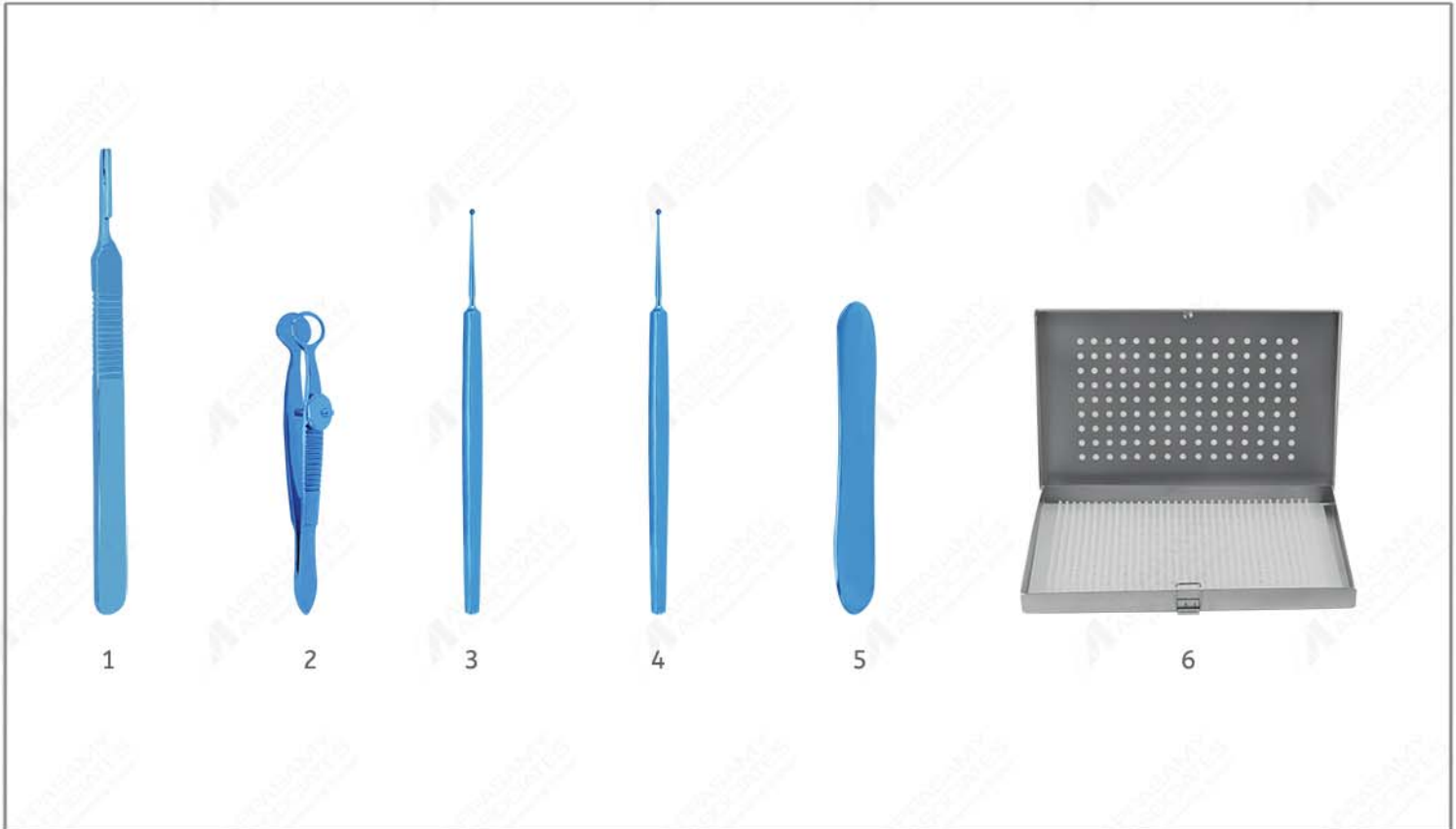

1. **AAT 5460** Bard- Parker Handle #3 Flat
2. **AAT 3625** Desmarres Chalazion Forceps 13mm/20mm dia
3. **AAT 1875** Meyerhoefer Chalazion Curette SIZE 0, 1.50mm dia
4. **AAT 1877** Meyerhoefer Chalazion Curette Size 2, 2.25mm dia
5. **AAT 1740** Jaeger Lid Plate
6. **AA 8005** Sterlization Box



1. **AAT 2140** Lasek Epithelial Micro Hoe
2. **AAT 2146** Tunnel Zone Marker
3. **AAT 2221** Optical Zone Marker Double ended
4. **AAT 2432** ICSR Tunnel Marker Left
5. **AAT 2433** ICSR Tunnel Marker Right
6. **AAT 2434** ICSR Tunnel Maker Double End Small
7. **AAT 2516** Flevator Far ICSR Implantation
8. **AAT 2517** SUAREZ SPREADER
9. **AAT 2518** Bicalto Guide
10. **AAT 3411** Nevyes wallace Fixation
11. **AAT 3671** ICSR Implantation 1x1 Teeth 0.2mm
12. **AA 8005** Sterilization Box

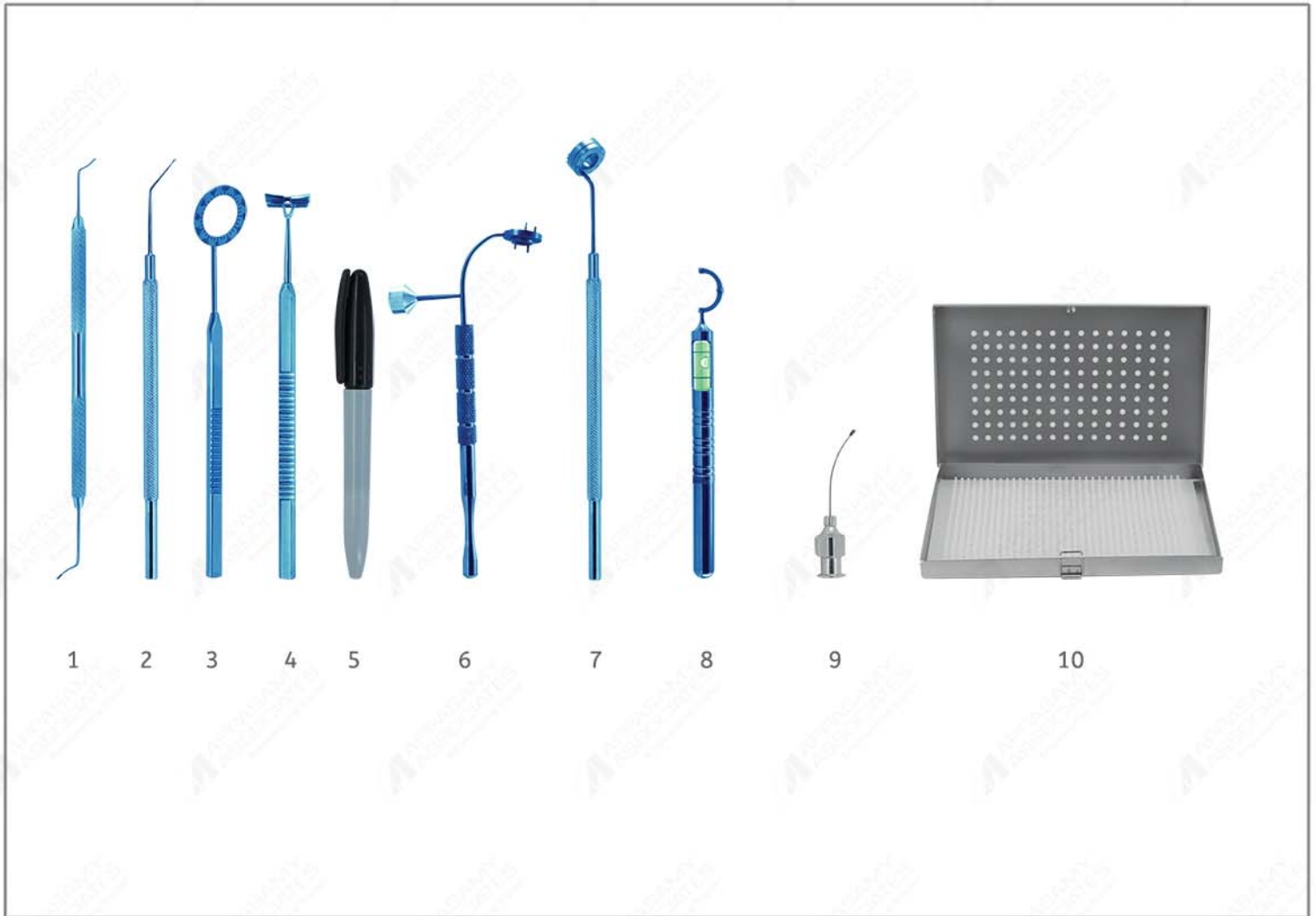

1. **AAT 1481** ZALDIVER LENS NANI PULATOR DOUBLE ENDED
2. **AAT 1482** Pallikaris Lens Manipulator
3. **AAT 2140** Limbal Relaxing Incision (LRI) Gauge
4. **AAT 2145** Bores Axis Marker Used With Mendez Degree Gauge
5. **AA 2300** Marking Pen, Fine Tip
6. **AAT 2815** TORIC COMBO MARKER
7. **AAT 2825** LRI Marker 40-60-80 degree
8. **AAT 2830** Pre-Op Toric Reference Marker, With Bubble Level
9. **AA 7621** Henderson MICS Capsule Polisher
10. **AA 8005** Sterlization Box

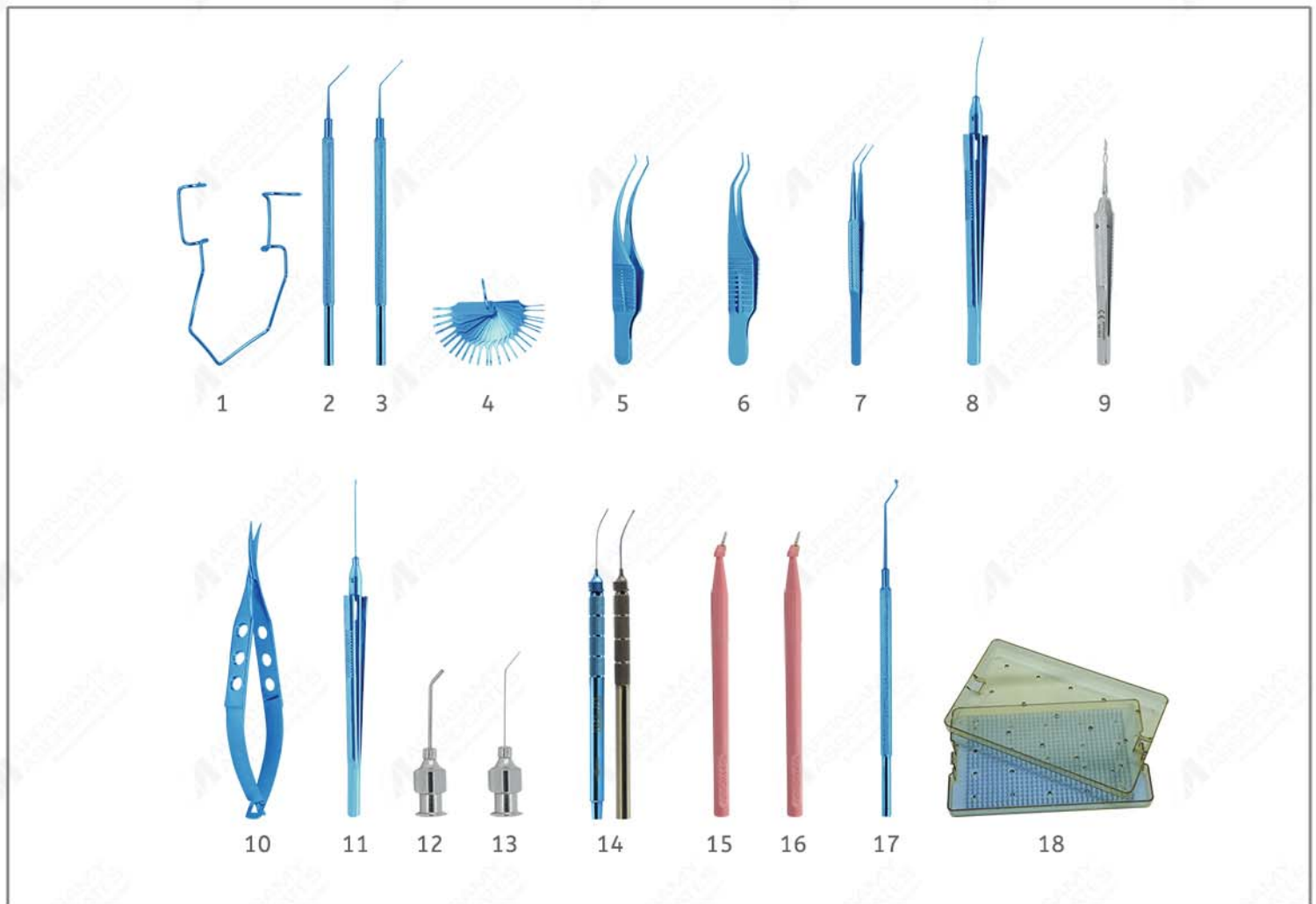

- | | |
|---|---|
| 1. AAT 1025 Kratz -Barraquer Wire Speculum,Big | 12. AA 7105 Rycroft Air Injection Cannula, 23g |
| 2. AAT 1465 Sinskey II Lens Manipulating Hook angled | 13. AA 7205 Pearce Hydrodissection Cannula, 25g |
| 3. AAT 1993 Agarwal Phaco Chopper 1mm Fully cutting edge | 14. AAT 7410/11 Appasamy Aspirating / Irrigating Handle, 23g |
| 4. AAT 2102 Appasamy Incision Gauge (0.80mm to 3.2mm) | 15. AA 572014 Ultra Thin Phaconit Blade, 1.4mm |
| 5. AAT 3030 Colibri Forceps 1x2 Teeth 0.12mm | 16. AA 572018 Ultra Thin Phaconit Blade, 1.8mm |
| 6. AAT 3805 Mc Pherson IOL Forceps 11mm Angled | 17. AAT 1597A Akahoshi Nucleus Ring Sustainer |
| 7. AAT 3868 Utrata Capsulorhexis Forceps, Round Handle, Extra delicate | 18. AA 8200 Appasamy Plastic Sterilization Box |
| 8. AAT 3872 Kreshner Micro Incision, 23g | |
| 9. AA 3913 Akahoshi Super Combo Prechopper | |
| 10. AAT 4155 Westcott Tenotomy Scissors | |
| 11. AAT 4461 Alio MICS Scissors, 23g | |